

# Schläuche

# 5

Zulaufschläuche.....	144
Brausenschläuche.....	147
Ablaufschläuche.....	148
Industrieschläuche.....	150
Trinkwasserschläuche.....	153
Zubehör.....	153



# Schläuche

## Zulaufschläuche

### CNS-Flexschläuche

### Universalschläuche



**Technische Daten:**  
Zulassung DVGW  
Arbeitsdruck 10bar  
Platzdruck 95bar

Pos.	GEV-Nr.	NW	Anschlüsse	L (mm)
1	520148	DN6	1/8"	200
2	520610	DN6	1/8"	300
3	520611	DN6	1/8"	600
4	520459	DN8	3/8"-1/2"	740
5	540265	DN10	3/8"	300
6	540266	DN10	3/8"	500
7	520568	DN10	3/8"	750
8	520567	DN10	3/8"	1000
9	520571	DN10	3/8"-1/2"	750
10	520632	DN10	1/2"	500
11	520612	DN10	1/2"	1000
12	520613	DN10	1/2"	1500
13	520633	DN10	1/2"	2000
14	545306	DN10	1/2"	2500
15	520626	DN12	1/2"	1500
16	520625	DN12	1/2"-3/4"	1500
17	520635	DN12	3/4"	500
18	520614	DN12	3/4"	1000
19	520615	DN12	3/4"	1500
20	520627	DN12	3/4"	2000



**Technische Daten:**  
Zulassung DVGW  
Arbeitsdruck 10bar  
Platzdruck 95bar

Abb.	GEV-Nr.	NW	A	B	L (mm)
1	520576	DN6	3/8"	3/8"	290
1	520533	DN6	1/2"	1/2"	2500
1	520569	DN8	3/8"	3/8"	370
1	520570	DN8	3/8"	3/8"	2000
1	520468	DN8	1/2"	3/8"	350
1	520541	DN8	3/4"	3/8"	1500
1	520583	DN8	3/4"	3/8"	1500
1	520563	DN10	1/2"	1/2"	1000
1	520564	DN10	1/2"	1/2"	1500

Abb.	GEV-Nr.	NW	A	B	L (mm)
1	520636	DN10	1/2"	1/2"	2000
1	520565	DN10	1/2"	1/2"	2500
1	520005	DN10	3/4"	3/4"	1500
1	520006	DN10	3/4"	3/4"	2500
1	520629	DN12	3/4"	3/4"	1000
1	520008	DN12	3/4"	3/4"	1500
1	520628	DN12	3/4"	3/4"	2000
1	520009	DN12	3/4"	3/4"	2500
1	520004	DN15	3/4"	3/4"	1500
1	520007	DN15	3/4"	3/4"	2500
1	520584	DN12	3/4"	3/4"	2000



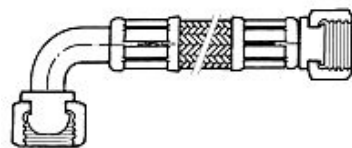

**Technische Daten:**  
Zulassung DVGW  
Arbeitsdruck 10bar  
Prüfdruck 32bar  
Platzdruck 95bar

Pos.	GEV-Nr.	NW	Anschlüsse	L (mm)	Pos.	GEV-Nr.	NW	Anschlüsse	L (mm)
1	520618	DN8	3/8"	300	4	520621	DN8	3/8"	1000
2	520619	DN8	3/8"	500	5	520624	DN8	3/8"	1200
3	520620	DN8	3/8"	750	6	520622	DN8	3/8"	1500



**Technische Daten:**  
Zulassung DVGW  
Arbeitsdruck 10bar  
Prüfdruck 32bar  
Platzdruck 95bar

Pos.	GEV-Nr.	NW	Anschlüsse	L (mm)
1	520634	DN8	3/8"	500

**Technische Daten:**  
Zulassung DVGW  
Arbeitsdruck 10bar  
Platzdruck 95bar



Pos.	GEV-Nr.	NW	Anschlüsse	L (mm)	Pos.	GEV-Nr.	NW	Anschlüsse	L (mm)
1	520616	DN6	1/8"	370	6	520572	DN8	3/8"	500
2	520617	DN6	1/8"	1500	7	520600	DN8	3/8"	750
3	520149	DN6	1/4"	280	8	520601	DN8	3/8"	1000
4	520256	DN8	3/8"	330	9	520602	DN8	3/8"	1500
5	520299	DN8	3/8"	450	10	520603	DN8	3/8"	2000

Armaturenschläuche



1

Abb.	GEV-Nr.	NW	Anschlüsse	L (mm)	Arbeitsdruck (bar)	Platzdruck (bar)	Zulassung
1	514337	DN8	1/2" - 3/8"	800	10	95	DVGW
1	520733	DN10	1/2" - 1/2"	400	10	95	DVGW
1	520900	DN10	3/4" - 1/8"	700	10	95	DVGW
1	520104	DN10	1/2" - 3/8"	500	10	95	DVGW
1	520638	DN10	1/2" - 3/8"	800	10	95	DVGW
1	520643	DN10	1/2" - 3/8"	1200	10	95	DVGW



**Technische Daten:**  
Zulassung DVGW  
Arbeitsdruck 10bar  
Platzdruck 95bar

Abb.	GEV-Nr.	NW	Anschlüsse	L (mm)	Abb.	GEV-Nr.	NW	Anschlüsse	L (mm)
1	520604	DN8	3/8"	500	1	520606	DN8	3/8"	1500
1	520605	DN8	3/8"	1000	1	520607	DN8	3/8"	2000



2

Abb.	GEV-Nr.	NW	Anschlüsse	L (mm)	Arbeitsdruck (bar)	Platzdruck (bar)	Zulassung
2	520639	DN8	3/8" - M10x1	300	10	95	DVGW
2	520105	DN8	3/8" - M10x1	500	10	95	DVGW
2	520640	DN8	1/2" - M10x1	300	10	95	DVGW
2	520102	DN8	1/2" - M10x1	500	10	95	DVGW

**Technische Daten:**  
Zulassung DVGW  
Arbeitsdruck 10bar  
Platzdruck 95bar

Abb.	GEV-Nr.	NW	Anschlüsse	L (mm)	Abb.	GEV-Nr.	NW	Anschlüsse	L (mm)
1	520623	DN8	3/8"	300	1	520910	DN8	3/8"	500



3

Abb.	GEV-Nr.	NW	Anschlüsse	L (mm)	Arbeitsdruck (bar)	Platzdruck (bar)	Zulassung
3	520641	DN8	3/8" - M10x1	300	10	95	DVGW
3	520106	DN8	3/8" - M10x1	500	10	95	DVGW
3	520453	DN8	3/8" - M10x1	500	10	95	DVGW
3	520103	DN8	1/2" - M10x1	500	10	95	DVGW



4

Abb.	GEV-Nr.	NW	Anschlüsse	L (mm)	Arbeitsdruck (bar)	Platzdruck (bar)	Zulassung
4	520466	DN8	3/8" - M10x1	500	10	95	DVGW
4	549924 <sup>1</sup>	DN8	3/8" - M10x1	500	10	95	DVGW
4	520465	DN8	1/2" - M10x1	500	10	95	DVGW
4	549923 <sup>1</sup>	DN8	1/2" - M10x1	500	10	95	DVGW
4	520472	DN8	1/2" - M10x1	800	10	95	DVGW

<sup>1</sup>mit CNS-Anschlüssen

5



Abb.	GEV-Nr.	NW	Anschlüsse	L (mm)	Arbeitsdruck (bar)	Platzdruck (bar)	Zulassung
5	592154	DN10	1/2" - M14x1	500	10	95	DVGW
5	592155	DN10	1/2" - M14x1	600	10	95	DVGW
5	592156	DN10	1/2" - M14x1	800	10	95	DVGW
5	520392	DN12	3/4" - 3/8"	700	10	95	DVGW
5	520393	DN12	3/4" - 3/8"	1000	10	95	DVGW

1



Abb.	GEV-Nr.	NW	Anschluss	L (mm)	Arbeitsdruck (bar)	Platzdruck (bar)	Zulassung
1	540263	DN8	3/8" - ø10mm	300	10	95	DVGW
1	540264	DN8	3/8" - ø10mm	500	10	95	DVGW

1



Abb.	GEV-Nr.	NW	Anschluss	L (mm)	Arbeitsdruck (bar)	Platzdruck (bar)	Zulassung
1	540261	DN8	ø10mm - ø10mm	300	10	95	DVGW
1	540262	DN8	ø10mm - ø10mm	500	10	95	DVGW

**PVC-Zulaufschläuche**

1



Abb.	GEV-Nr.	NW	Anschlüsse	L (mm)	Arbeitsdruck (bar)	T.max. (°C)	Zulassung
1	520460	DN12	3/4"	1500	10	90	WRAS
1	520461	DN12	3/4"	2500	10	90	WRAS

2



Abb.	GEV-Nr.	NW	Anschlüsse	L (mm)	Arbeitsdruck (bar)	T.max. (°C)	Zulassung
2	520462	DN12	3/4"	1500	10	90	WRAS
2	520463	DN12	3/4"	2500	10	90	WRAS

3



Abb.	GEV-Nr.	NW	Anschlüsse	L (mm)	Arbeitsdruck (bar)	T.max. (°C)	Zulassung
3	520010	DN13	3/4"	1500	10	90	VDE
3	520011	DN13	3/4"	2000	10	90	VDE
3	520012	DN13	3/4"	2500	10	90	VDE
3	520013	DN13	3/4"	3000	10	90	VDE

1



Abb.	GEV-Nr.	NW	Anschlüsse	L (mm)	Arbeitsdruck (bar)	T.max. (°C)	Zulassung
1	520630	DN13	3/4"	1000	10	90	VDE
1	520631	DN13	3/4"	1500	10	90	VDE

2





Abb.	GEV-Nr.	NW	Anschlüsse	L (mm)	Arbeitsdruck (bar)	T.max. (°C)	Zulassung
2	520888	DN14	3/4"	1500	10	90	VDE

1



**Technische Daten:**  
 Arbeitsdruck 10bar  
 Temperatur max. 90°C  
 Zulassung KTW

Abb.	GEV-Nr.	NW	Anschlüsse	L (mm)
1	520644	DN10	3/4"	1000+250/250

## Brausenschläuche

### CNS-Flexschläuche

1 

Abb.	GEV-Nr.	Anschlüsse	L (mm)	Arbeitsdruck (bar)	Platzdruck (bar)	T.max. (°C)	Zulassung
1	542063	1/2"	630	10	90	90	KTW
1	542014	1/2"	850	10	90	90	KTW
1	542015	1/2"	1000	10	90	90	KTW
1	542016	1/2"	1100	10	90	90	KTW
1	542017	1/2"	1200	10	90	90	KTW
1	542018 <sup>1</sup>	1/2"	1500	10	90	90	KTW
1	542019 <sup>1</sup>	1/2"	2000	10	90	90	KTW

<sup>1</sup>PVC überzogen

2 

Abb.	GEV-Nr.	Anschlüsse	L (mm)	Arbeitsdruck (bar)	Platzdruck (bar)	T.max. (°C)	Zulassung
2	542065 <sup>1</sup>	1/2"	1000	10	90	90	DVGW

<sup>1</sup>PVC überzogen

3 

Abb.	GEV-Nr.	Anschlüsse	L (mm)	Arbeitsdruck (bar)	Platzdruck (bar)	T.max. (°C)	Zulassung
3	542129	1/2"	1000	10	90	90	DVGW

4 

Abb.	GEV-Nr.	Anschlüsse	L (mm)	Arbeitsdruck (bar)	Platzdruck (bar)	T.max. (°C)	Zulassung
4	542020 <sup>1</sup>	1/2"	1050	10	90	70	DVGW
4	542021 <sup>1</sup>	1/2"	1200	10	90	70	DVGW

<sup>1</sup>PVC überzogen

5 

Abb.	GEV-Nr.	Anschlüsse	L (mm)	Arbeitsdruck (bar)	Platzdruck (bar)	T.max. (°C)	Zulassung
5	520730	1/2"	2400	10	90	90	DVGW
5	520729	1/2"	2800	10	90	90	DVGW
5	520731	1/2"	3200	10	90	90	DVGW

### CNS-Spiralschläuche

1 

Abb.	GEV-Nr.	Anschlüsse	L (mm)	Arbeitsdruck (bar)	Platzdruck (bar)	T.max. (°C)	Zulassung
1	540290	1/2"	1500	10	100	70	-
1	540291	1/2"	2000	10	100	70	-

2 

Abb.	GEV-Nr.	Anschlüsse	L (mm)	Arbeitsdruck (bar)	Platzdruck (bar)	T.max. (°C)	Zulassung
2	540230	1/2"	2000	10	40	90	KTW
2	540231	1/2"	2500	10	40	90	KTW
2	540239	1/2"	3000	10	40	90	KTW

3 

Abb.	GEV-Nr.	Anschlüsse	L (mm)	Arbeitsdruck (bar)	Platzdruck (bar)	T.max. (°C)	Zulassung
3	549280	1/2"	3000	10	40	90	KTW

4 

Abb.	GEV-Nr.	Anschlüsse	L (mm)	Arbeitsdruck (bar)	Platzdruck (bar)	T.max. (°C)	Zulassung
4	545127	7/8"-20UNEF	430	10	40	90	WRAS/ACS
4	593012	7/8"-20UNEF	950	10	40	90	WRAS/ACS

5 

Abb.	GEV-Nr.	Anschlüsse	L (mm)	Arbeitsdruck (bar)	Platzdruck (bar)	T.max. (°C)	Zulassung
5	545128	7/8"-20UNEF	490	10	40	90	WRAS/ACS
5	547594	7/8"-20UNEF	950	10	40	90	WRAS/ACS

### CNS-Spiralschläuche mit Knickschutz

1 

Abb.	GEV-Nr.	Anschlüsse	L (mm)	Arbeitsdruck (bar)	Platzdruck (bar)	T.max. (°C)	Zulassung
1	592222 <sup>1</sup>	1/2"	630	10	40	90	NSF
1	540292 <sup>1</sup>	1/2"	875	10	40	90	KTW
1	542119 <sup>2</sup>	1/2"	875	10	40	90	KTW
1	540066 <sup>1</sup>	1/2"	1000	10	40	90	KTW
1	549485 <sup>2</sup>	1/2"	1000	10	40	90	KTW
1	541812 <sup>1</sup>	1/2"	1075	10	40	90	KTW
1	542120 <sup>2</sup>	1/2"	1075	10	40	90	KTW
1	540070 <sup>1</sup>	1/2"	1250	10	40	90	KTW
1	549244 <sup>2</sup>	1/2"	1250	10	40	90	KTW
1	540224 <sup>1</sup>	1/2"	1500	10	40	90	KTW

<sup>1</sup>Messingbuchse <sup>2</sup>Edelstahlbuchse

### Herausziehbare Schläuche

1 

Abb.	GEV-Nr.	Anschlüsse	L (mm)	Arbeitsdruck (bar)	Platzdruck (bar)	T.max. (°C)	Zulassung
1	541893	1/2" - M15x1	1250	8	30	60	-



2

Abb.	GEV-Nr.	Anschlüsse	L (mm)	Arbeitsdruck (bar)	Platzdruck (bar)	T.max. (°C)	Zulassung
2	546261 <sup>1</sup>	1/2" - M15x1	1450	10	40	90	-

<sup>1</sup>mit CNS-Anschlüssen

3

Abb.	GEV-Nr.	Anschlüsse	L (mm)	Arbeitsdruck (bar)	Platzdruck (bar)	T.max. (°C)	Zulassung
3	540455	1/2" - M15x1	1500	10	40	90	-

## Hytrell-Schläuche

1

Abb.	GEV-Nr.	Anschlüsse	L (mm)	Arbeitsdruck (bar)	Platzdruck (bar)	T.max. (°C)	Zulassung
1	540145	1/2"	950	10	40	90	KTW
1	540146	1/2"	1200	10	40	90	KTW
1	540147	1/2"	2000	10	40	90	KTW

## PVC-Gewebeschläuche

1

Abb.	GEV-Nr.	Anschlüsse	L (mm)	Arbeitsdruck (bar)	Platzdruck (bar)	T.max. (°C)	Zulassung
1	540293	1/2"	1000	8	30	60	-
1	540294	1/2"	1200	8	30	60	-
1	540295	1/2"	1500	8	30	60	-
1	540297	1/2"	2000	8	30	60	-

2

Abb.	GEV-Nr.	Anschlüsse	L (mm)	Arbeitsdruck (bar)	Platzdruck (bar)	T.max. (°C)	Zulassung
2	520272	1/2"	1000	10	30	60	NSF
2	520277	1/2"	1500	10	30	60	NSF
2	520311	1/2"	1800	10	18	60	NSF
2	520096	1/2"	2000	10	30	60	NSF
2	520097	1/2"	2200	10	30	60	NSF
2	520098	1/2"	2600	10	30	60	NSF

## Ablaufschläuche

1

Abb.	GEV-Nr.	NW	L (mm)	gerade ø innen (mm)	gerade ø außen (mm)	Schlauch ø außen (mm)
1	513718	DN19	1500	24	28	23
1	508043	DN19	2000	19/30	26/34	25
1	530587	DN28	2000	32	40	35
1	524488	DN34	1000	36	42	42
1	530615	DN40	1000	58	65	47

1

Abb.	GEV-Nr.	NW	L (mm)	gebogen ø innen (mm)	gebogen ø außen (mm)	Schlauch ø außen (mm)
1	505081	DN25	1500	31	40	31
1	505082	DN25	1500	48	58	31
1	505298	DN35	1500	40	45	43

1

Abb.	GEV-Nr.	NW	L (mm)	A ø innen (mm)	A ø außen (mm)	B ø innen (mm)	B ø außen (mm)
1	530374	DN19	160	28	34	28	34
1	530724	DN19	180	19	27	19	27
1	513258	DN19	280	22	28	24	28
1	530357	DN19	300	29	34	29	34
1	518219	DN19	630	19	27	21	28
1	507329	DN19	1500	19	24	21	28
1	518518	DN19	1500	21	27	29	35
1	511205	DN19	1500	23	29	29	35
1	530338	DN19	1500	19/23/40	45	22	26
1	530726	DN19	1530	19	23	22	28
1	524257	DN19	1700	21	27	29	34
1	530489	DN19	2000	22	27	19	24
1	530298	DN19	2100	19	25	19	25
1	501136	DN19	2500	19	24	21	28
1	504253	DN21	1600	35	40	40	46
1	530570	DN21	2000	21	25	20/29	27/35
1	530631	DN21	2500	21	25	20/29	27/35
1	530632	DN21	3500	21	25	20/29	27/35
1	507207	DN24	1500	24	28	24	28
1	530608	DN24	1500	24	28	28	35
1	513051	DN24	2000	24	28	24	28

Tabellenfortsetzung auf der nächsten Seite



Abb.	GEV-Nr.	NW	L (mm)	A ø innen (mm)	A ø außen (mm)	B ø innen (mm)	B ø außen (mm)
1	530607	DN24	2000	24	28	28	35
1	507211	DN26	1500	33	40	32	40
1	530575	DN31	1000	36	40	40	46
1	530573	DN31	1500	31	35	40	46
1	530083	DN31	1500	31	35	452	46
1	530574	DN31	2000	31	35	40	46
1	530399	DN31	2000	33	39	33	39
1	511734	DN35	310	35	40	35	40
1	504254	DN35	1600	35	41	41	49



Abb.	GEV-Nr.	NW	L (mm)	A ø innen (mm)	A ø außen (mm)	B ø innen (mm)	B ø außen (mm)	Schlauch ø außen (mm)
1	530612	DN21	1350-4000	21	27	29	35	29
1	530640	DN21	750-2000	21	27	29	35	29



Abb.	GEV-Nr.	NW	L (mm)	gerade ø innen (mm)	gerade ø außen (mm)	Anschluss	Schlauch ø außen (mm)
1	515081	DN35	400	35	40	1½"	37
1	515082	DN35	750	35	40	1½"	37



Abb.	GEV-Nr.	NW	L (mm)	gerade ø innen (mm)	gerade ø außen (mm)	gebogen ø innen (mm)	gebogen ø außen (mm)	Schlauch ø außen (mm)
1	504252	DN1,5	2150	18	24	28	34	24
1	530722	DN19	180	19	25	21	27	24
1	530372	DN19	1000	21	27	21	28	24
1	506207	DN19	1500	19	24	21	27	25
1	518600	DN19	1500	19	24	22	27	24
1	530064	DN19	1500	19/23/40	24/28/46	22	26	28
1	530473	DN19	1900	19	25	23	27	24
1	530299	DN19	2000	19	25	21	27	25
1	505084	DN19	2000	21	26	21	27	27
1	530613	DN19	3000	21	27	21	27	20
1	524819	DN20	720	22	28	22	28	25
1	530819	DN20	2500	20	24	22	27	24
1	530614	DN21	1750	21	27	28	34	27
1	530382	DN21	2500	21	26	21	27	24
1	530571	DN24	1500	24	29	29	35	28
1	519272	DN24	1500	32	35	40	46	38
1	518638	DN24	1700	28	34	28	34	30
1	530572	DN24	2000	24	29	29	35	29
1	530069	DN24	2000	32	35	40	46	38
1	506208	DN25	1500	25	30	40	46	31
1	518515	DN28	260	33	40	52	58	35
1	502100	DN32	1500	33,5	39	40	44	38
1	518103	DN32	2000	32	35	50	58	38
1	518078	DN34	500	40	48	50	58	42



Abb.	GEV-Nr.	NW	L (mm)	gerade ø innen (mm)	gerade ø außen (mm)	gebogen ø innen (mm)	gebogen ø außen (mm)	Schlauch ø außen (mm)
2	502143	DN32	1600	33	39	40	43	40

## Industrieschläuche

## EPDM-Schläuche



1

Abb.	GEV-Nr.	ID ø (mm)	AD ø (mm)	L (m)	Arbeitsdruck (bar)	Platzdruck (bar)	T.max. (°C)
1	520015	10	17	5	20	60	95
1	520014	10	17	40	20	60	95
1	520017	13	20	5	20	60	95
1	520016	13	20	40	20	60	95

## Gummischläuche - Goldschlange®



1

Abb.	GEV-Nr.	ID ø (mm)	AD ø (mm)	L (m)	Arbeitsdruck (bar)	Platzdruck (bar)	T.max. (°C)
1	530540	13	21	5	30	90	100
1	530546	13	21	20	30	90	100

## Niplaflex-Schläuche



1

Pos.	GEV-Nr.	ID ø (mm)	AD ø (mm)	L (m)	Arbeitsdruck (bar)	Platzdruck (bar)	T.max. (°C)
1	530561	10	17	5	10	30	110
2	570561	10	17	40	10	30	110
3	530719	11	18	0,4	10	30	110
4	530398	12	19	0,3	10	30	110
5	570562	12	20	100	10	30	110
6	530562	13	21	5	10	30	110
7	530051 <sup>1</sup>	15	25	-	10	30	110

<sup>1</sup>Meterware

## Nylonschläuche



1

Abb.	GEV-Nr.	ID ø (mm)	AD ø (mm)	L (m)	Arbeitsdruck (bar)	Platzdruck (bar)	T.max. (°C)
1	570146	4	6	1	10	50	100
1	520032	4	6	5	10	50	100
1	570025	4	6	50	10	50	100



1

Abb.	GEV-Nr.	NW	L (mm)	gerade ø innen (mm)	gerade ø außen (mm)	gebogen ø innen (mm)	gebogen ø außen (mm)	Schlauch ø außen (mm)
1	524807	DN19	1800	19	25	29	37	24
1	504291	DN20	2200/800	20	27	29	36	27
1	504343	DN21	2200/800	29	21	29	35	27



1

Abb.	GEV-Nr.	NW	L (mm)	gebogen ø innen (mm)	gebogen ø außen (mm)	Schlauch ø außen (mm)
1	518653	DN24	500	29	34	29

## Anschlussstücke



1

Abb.	GEV-Nr.	Schlauch ø (mm)	gerade ø innen (mm)	gerade ø außen (mm)
1	520040	19	18	24
1	520041	19	21	27
1	520043	19	29	35
1	520042	22	21	27



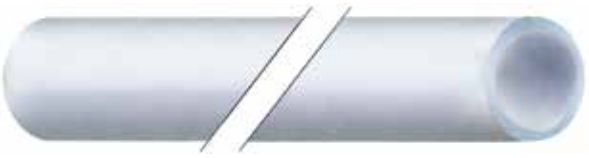

2

Abb.	GEV-Nr.	ID ø (mm)	AD ø (mm)	L (m)	Arbeitsdruck (bar)	Platzdruck (bar)	T.max. (°C)
2	520091	4	6	2	10	50	100
2	520031	4	6	5	10	50	100
2	520251	4	6	50	10	50	100
2	520252	6	8	5	10	50	100
2	520253	6	8	50	10	50	100
2	530566	8	10	5	10	50	100
2	570566	8	10	50	10	50	100

### PE-Schläuche

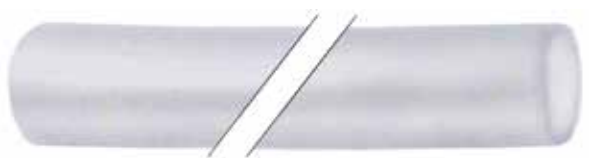

1

Abb.	GEV-Nr.	ID ø (mm)	AD ø (mm)	L (m)	Arbeitsdruck (bar)	Platzdruck (bar)	T.max. (°C)
1	520549 <sup>1</sup>	6	8	-	6	10	65

<sup>1</sup>Meterware

### Pressostatschläuche



Pos.	GEV-Nr.	ID ø (mm)	AD ø (mm)	L (m)	Arbeitsdruck (bar)	Platzdruck (bar)	Temp.Best. (°C)
1	530068	4	8,5	1	30	90	60
2	530429	4	8,5	1,15	30	90	60
3	530563	4	8,5	5	30	90	60
4	530560	5	9	5	30	90	60
5	570560	5	9	20	30	90	60

### PTFE-Schläuche



Pos.	GEV-Nr.	AD ø (mm)	ID ø (mm)	L (m)	Pos.	GEV-Nr.	AD ø (mm)	ID ø (mm)	L (m)
1	520845 <sup>1</sup>	6	3	-	2	527919	12	10	1

<sup>1</sup>Meterware

### PVC-Schläuche

#### PVC-Gewebesschläuche



Pos.	GEV-Nr.	ID ø (mm)	AD ø (mm)	L (m)	Arbeitsdruck (bar)	Platzdruck (bar)	T.max. (°C)
1	520018	4	10	5	10	30	60
2	570018	4	10	50	10	30	60
3	520019	6	12	5	10	30	60
4	570020	6	12	50	10	30	60
5	530564	10	16	10	10	30	60
6	570564	10	16	50	10	30	60
7	530565	13	19	10	10	30	60
8	570565	13	19	50	10	30	60
9	520544	19	27	5	10	30	60
10	570544	19	27	50	10	30	60

#### PVC-Gewebesschläuche mit SK-Zeichen

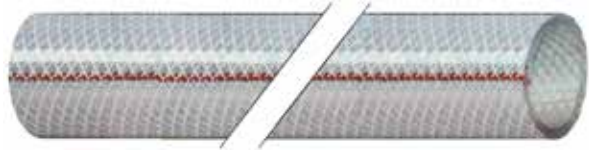

Pos.	GEV-Nr.	ID ø (mm)	AD ø (mm)	L (m)	Arbeitsdruck (bar)	Platzdruck (bar)	T.max. (°C)
1	520030	6	12	10	16	30	80
2	520048	6	12	20	16	30	80
3	570048	6	12	50	16	30	80

#### PVC-Schläuche ohne Gewebe



1

Abb.	GEV-Nr.	ID ø (mm)	AD ø (mm)	L (m)	T.max. (°C)	Abb.	GEV-Nr.	ID ø (mm)	AD ø (mm)	L (m)	T.max. (°C)
1	520090	4	6	2	60	1	520545	5	8	10	60
1	570123	4	6	3,5	60	1	570545	5	8	100	60
1	520582	4	6	4	60	1	520278	6	8	2	60
1	570127	4	6	4	60	1	520028	6	8	10	60
1	520026	4	6	10	60	1	570028	6	8	100	60
1	570026	4	6	100	60	1	520279	6	9	2	60
1	520027	4	7	10	60	1	520029	6	9	10	60
1	570027	4	7	100	60	1	570029	6	9	100	60
1	520380	5	7	2	60	1	520022	8	12	10	60
1	520046	5	7	10	60	1	570022	8	12	50	60
1	570046	5	7	100	60	1	570000	10	14	1,1	60



2

Abb.	GEV-Nr.	ID ø (mm)	AD ø (mm)	L (m)	T.max. (°C)	Abb.	GEV-Nr.	ID ø (mm)	AD ø (mm)	L (m)	T.max. (°C)
2	520383	4	6	2	60	2	520381	5	8	2	60
2	520384	4	6	10	60	2	520382	5	8	10	60
2	570383	4	6	100	60	2	570381	5	8	100	60

### Saug- und Druckschläuche



Pos.	GEV-Nr.	ID ø (mm)	AD ø (mm)	L (m)	Arbeitsdruck (bar)	Platzdruck (bar)	Temp.Best. (°C)
1	570202 <sup>1</sup>	7	13	-	10	30	-30 bis +80
2	530340	25	35	0,5	10	30	-30 bis +80
3	530440	25	35	1	10	30	-30 bis +80
4	530441	28	38	1	10	30	-30 bis +80
5	530442	32	40	1	10	30	-30 bis +80
6	530342	32	43	0,5	10	30	-30 bis +80
7	530343	35	46	0,5	10	30	-30 bis +80
8	530443	35	48	1	10	30	-30 bis +80
9	530344	38	50	0,5	10	30	-30 bis +80
10	530444	38	50	1	10	30	-30 bis +80
11	530345	40	53	0,5	10	30	-30 bis +80
12	530445	40	53	1	10	30	-30 bis +80
13	530446	42	55	1	10	30	-30 bis +80
14	530447	45	59	1	10	30	-30 bis +80
15	530348	48	61	0,5	10	30	-30 bis +80
16	530349	50	64	0,5	10	30	-30 bis +80
17	530449	50	64	1	10	30	-30 bis +80
18	530350	60	74	0,5	10	30	-30 bis +80
19	530450	60	74	1	10	30	-30 bis +80
20	530351	63	79	0,5	10	30	-30 bis +80
21	530451	63	79	1	10	30	-30 bis +80

<sup>1</sup>Meterware

### Schläuche mit Drahtverstärkung



Pos.	GEV-Nr.	ID ø (mm)	AD ø (mm)	L (m)	Pos.	GEV-Nr.	ID ø (mm)	AD ø (mm)	L (m)
1	520679	12	18	5	8	520687	18	25	5
2	520034	12	18	30	9	520037	18	25	30
3	520489	14	20	1,5	10	520688	20	27	5
4	520686	14	20	5	11	520038	20	27	30
5	520035	14	20	30	12	520920	22	28	5
6	520072	16	21	5	13	520911	22	28	30
7	520036	16	21	30	14	520921	25	31	5

Pos.	GEV-Nr.	ID ø (mm)	AD ø (mm)	L (m)	Pos.	GEV-Nr.	ID ø (mm)	AD ø (mm)	L (m)
15	520912	25	31	30	17	520922	32	40	5
16	506074	31	41	1	18	520913	32	40	30

### Silikonschläuche

#### ohne Gewebe

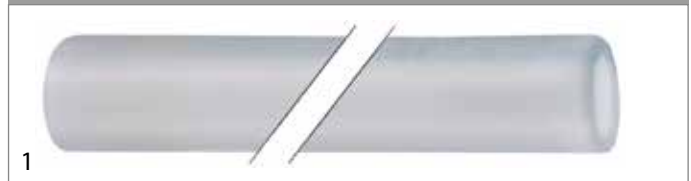

1

Abb.	GEV-Nr.	ID ø (mm)	AD ø (mm)	L (m)	T.max. (°C)
1	361601	2	5,2	5	200
1	570601	2	5,2	100	200
1	361602	2,5	5,7	5	200
1	570602	2,5	5,7	100	200
1	361603	3	5	5	200
1	570603	3	5	100	200
1	361604	3	6	5	200
1	570604	3	6	100	200
1	361605	3	7	5	200
1	570605	3	7	100	200
1	520242	4	7	5	200
1	570606	4	7	100	200
1	361607	4	7,2	5	200
1	361608	4	8	5	200
1	570608	4	8	100	200
1	520388	5	8	1	200
1	361609	5	8	5	200
1	570004	5	8	25	200
1	570609	5	8	100	200
1	570005	5	9	1	200
1	361610	5	9	5	200
1	570006	5	9	5	200
1	570843	5	9	25	200
1	530550	6	10	5	200
1	570550	6	10	100	200
1	570036	6	11	1	200
1	570013	6	11	5	200
1	570012	6	11	25	200
1	570041	8	12	1	200
1	530820	8	14	1	200
1	530552	8	14	5	200
1	570552	8	14	25	200
1	530821	10	15	1	200
1	530822	10	16	1	200
1	570069	10	16	5	200
1	530823	12	16	1	200
1	530555	12	18	5	200
1	530060	13	19	1	200
1	570060	13	19	25	200
1	530061	14	20	1	200
1	570061	14	20	25	200
1	530062	16	23	1	200
1	570062	16	23	25	200

Tabellenfortsetzung auf der nächsten Seite



1



Abb.	GEV-Nr.	ID ø (mm)	AD ø (mm)	L (m)	T.max. (°C)
1	530063	18	25	1	200
1	570063	18	25	25	200
1	520399	18	26	1	200
1	570121 <sup>1</sup>	20	26	-	200
1	530052	43	51	80	200
1	530067	50	56	0,13	200

<sup>1</sup>Meterware

2

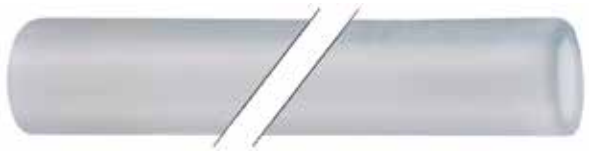

Abb.	GEV-Nr.	ID ø (mm)	AD ø (mm)	L (m)	T.max. (°C)
2	520842	3	6	1	200
2	570147	3	7	1,6	200
2	520844	6	9	1	200
2	520841	6	12	1	200
2	520840	9	13	1	200

mit Gewebe

mit Glasseideumflechtung



Pos.	GEV-Nr.	ID ø (mm)	AD ø (mm)	L (m)	Arbeitsdruck (bar)	T.max. (°C)
1	520023	6	12	5	4	200
2	570023	6	12	25	4	200
3	520024	9,5	17	5	4	200

mit Monofilumflechtung



Pos.	GEV-Nr.	ID ø (mm)	AD ø (mm)	L (m)	Arbeitsdruck (bar)	T.max. (°C)
1	530693	10	17	1	4	200
2	530542	10	17	5	4	200
3	570542	10	17	50	4	200
4	520025	12	19	5	4	200
5	570125	12	19	25	4	200
6	530543	13	21	5	4	200

für Schlauchpumpen



Pos.	GEV-Nr.	ID ø (mm)	AD ø (mm)	L (m)	T.max. (°C)	Pos.	GEV-Nr.	ID ø (mm)	AD ø (mm)	L (m)	T.max. (°C)
1	361601	2	5,2	5	200	11	520242	4	7	5	200
2	570601	2	5,2	100	200	12	570606	4	7	100	200
3	361602	2,5	5,7	5	200	13	361607	4	7,2	5	200
4	570602	2,5	5,7	100	200	14	361608	4	8	5	200
5	361603	3	5	5	200	15	570608	4	8	100	200
6	570603	3	5	100	200	16	570611 <sup>1</sup>	5	8	-	200
7	361604	3	6	5	200	17	361609	5	8	5	200
8	570604	3	6	100	200	18	570609	5	8	100	200
9	361605	3	7	5	200	19	361610	5	9	5	200
10	570605	3	7	100	200	20	570550	6	10	100	200

<sup>1</sup>Meterware

## Trinkwasserschläuche

1



**Technische Daten:**  
Zulassung LMBG  
Temperaturbeständigkeit -20 bis +60°C  
Arbeitsdruck 15bar  
Platzdruck 45bar

Abb.	GEV-Nr.	ø (mm)	Länge	Abb.	GEV-Nr.	ø (mm)	Länge
1	520476	13x19	2,5m	1	520254	19x27	5m
1	520100	13x19	5m	1	520255	19x27	20m
1	520101	13x19	20m	1	520109	19x27	40m
1	520095	13x19	40m				

## Zubehör

1



Abb.	GEV-Nr.	Beschreibung
1	520053	Sieb Anschluss 3/4" D1 ø 26mm D2 ø 15mm VPE 10 Stück Gummi Materialstärke 8mm

