



Ersatzteile passend für: Mareno

Ersatzteile passend für Blockgeräte



Ersatzteile passend für Heißluftöfen und Combidämpfer



Ersatzteile passend für Klein- und Einzelgeräte



GEV GmbH
Großküchen-Ersatzteil-Vertrieb
Robert-Koch-Straße 3a
82152 Planegg/München
Deutschland

Telefon: +49 (0)89 745572-0
Telefax: +49 (0)89 745572-82
E-Mail: office@gev.at
Internet: www.gev-online.de



GEV GmbH
Ersatzteile und Zubehör
Kanalstrasse 14
5745 Safenwil
Schweiz

Telefon: +41 (0)62 797 87 70
Telefax: +41 (0)62 797 25 07
E-Mail: info@gev.ch
Internet: www.gev.ch



**GEV Großküchen-
Ersatzteil-Vertriebs GesmbH**
Austraße 12
5110 Oberndorf
Österreich

Telefon: +43 (0)6272 6688-0
Telefax: +41 (0)6272 6688-14
E-Mail: office@gev.at
Internet: www.gev.at

Members of the GEV GROUP

INHALTSVERZEICHNIS

Offene Kochstellen (Gas/Elektro)



ab Seite 4

Backöfen (Gas/Elektro)



ab Seite 11

Grillplatten (Gas/Elektro)

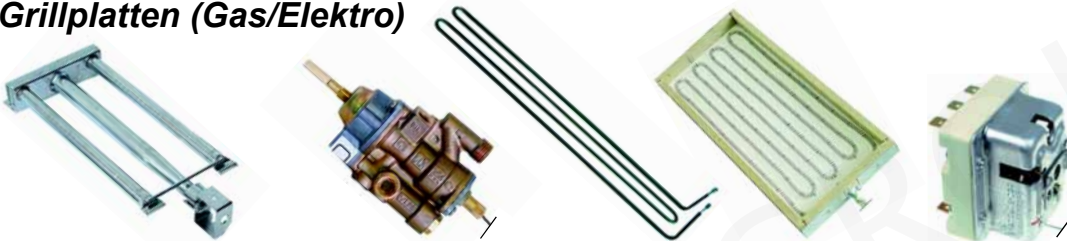

ab Seite 15

Lavasteingrills (Gas)



ab Seite 19

Rostbräter (Elektro), Bräter/Sudpfannen (Gas/Elektro)



ab Seite 19

Nudelkocher (Gas/Elektro)



ab Seite 22

INHALTSVERZEICHNIS

Bainmarie (Gas/Elektro)



ab Seite 26

Frittenwärmer (Elektro), Friteusen (Gas/Elektro)



ab Seite 30

Kippbratpfannen (Gas/Elektro)

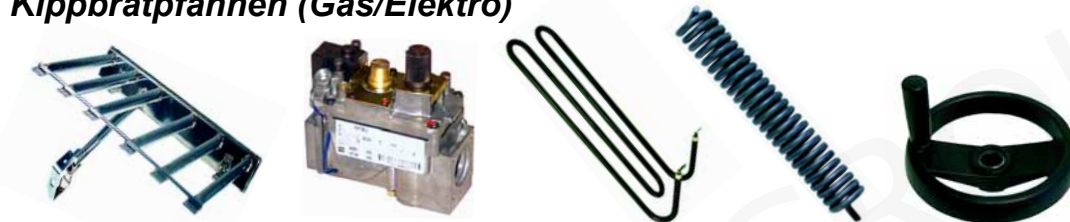

ab Seite 36

Kochkessel (Gas/Elektro)



ab Seite 41

Heißluftöfen/ Combidämpfer (Gas/Elektro)



ab Seite 48

Klein- und Einzelgeräte

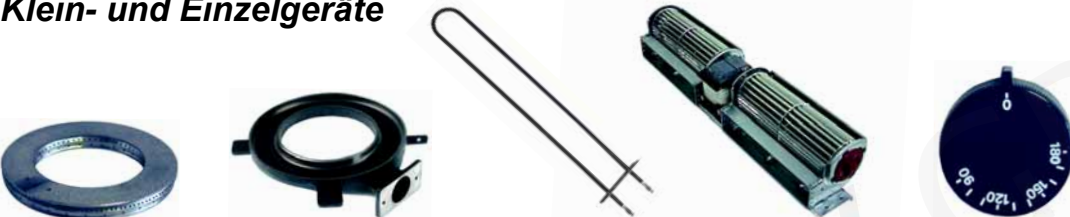

ab Seite 52

M Offene Kochstellen (Gas)

Passend für Mareno



Abb.	Bestell-Nr.	Beschreibung	Gerätetyp	Vergl.-Nr.
1	103066	Brennerdeckel, 80mm		10.32000700
2	103065	Brennerring	PCG40/60/100	10.32009500
3	104100	Brennertasse	KCF6G	10.32009300
4	104101	Düsenträger	CFG60	10.32009100



Abb.	Best.-Nr.	Beschreibung	Gerätetyp	Vergl.-Nr.
1	103068	Brennerdeckel, 100mm		10.32000800
2	103067	Brennerring	PCG40/60/100	10.32009600
3	104102	Brennertasse	KCF6G	10.32009400
4	104103	Düsenträger	CFG60	10.32009200



Abb.	Bestell-Nr.	Beschreibung	Gerätetyp	Vergl.-Nr.
1	100729	Zündkerze		10.31025600 10.47024200
2	100197	Zündkabel, 600mm	PCG40/60/100	10.47024300
3	100013	Piezozünder	KCF6G	10.31500600



Abb.	Bestell-Nr.	Beschreibung	Gerätetyp	Vergl.-Nr.
1	100729	Zündkerze		10.31025600
2	345314	Zündschalter		10.37102500
3	101003	Zündgruppe	LFGE60	10.37301400
4	100036	Zündkabel, 500mm		10.47102900
4	100037	Zündkabel, 1000mm		10.47103000

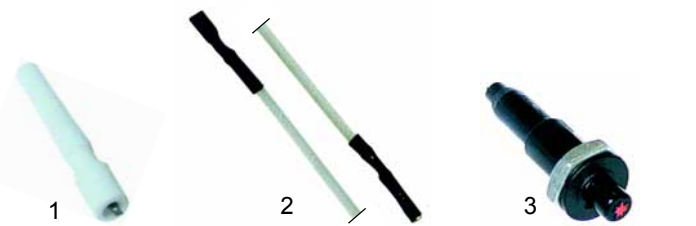

Abb.	Best.-Nr.	Beschreibung	Gerätetyp	Vergl.-Nr.
1	102054	Thermoelement, 320mm		10.33027100
1	102056	Thermoelement, 600mm		10.33027200
2	101154	Gashahn	PCG40/60/100 KCF6G CFG60	10.31028200 10.31028300
3	110406	Knebel		10.36700300 10.31018700

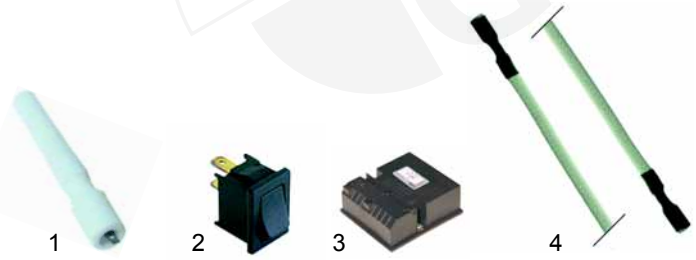

Abb.	Bestell-Nr.	Beschreibung	Gerätetyp	Vergl.-Nr.
1	103143	Brennerdeckel 3,5kW		10.32501400
2	103140	Brennertasse 3,5kW	PCG41/61	10.32101400
3	103146	Brennerpfeife	PCGD41/61	10.32101200
4	103148	Dichtung	CFG70/101	10.36607800
5	105230	Düsenstock		10.33717200

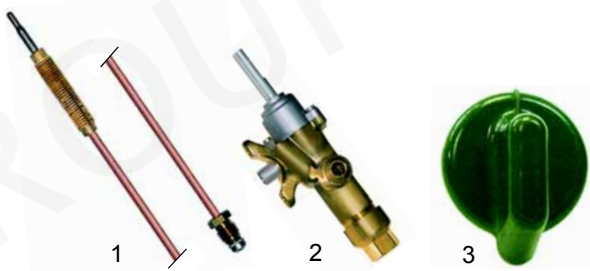

Abb.	Bestell-Nr.	Beschreibung	Gerätetyp	Vergl.-Nr.
1	nml.	Brennerdeckel, 5,5kW		10.32501600
2	nml.	Brennertasse, 5,5kW	PCG41/61	10.32101500
3	103147	Brennerpfeife	PCGD41/61	10.32101300
4	103149	Dichtung	CFG70/101	10.36607900
5	105230	Düsenstock		10.33717200



Abb.	Bestell-Nr.	Beschreibung	Gerätetyp	Vergl.-Nr.
1	103145	Brennerdeckel, 5,5kW		10.32501500
2	103142	Brennertasse, 5,5kW	PCG41/61	10.32101600
3	103147	Brennerpfeife	PCGD41/61	10.32101300
4	103149	Dichtung	CFG70/101	10.36607900
5	105230	Düsenstock		10.33717200



Abb.	Bestell-Nr.	Beschreibung	Gerätetyp	Vergleichs-Nr.
1	100082	Zündbrenner	PCG41/61	10.32501300
2	101860	Mutter M10x1	PCGD41/61	10.33514900
3	100834	Pilzkopf	CFG70/101	10.33717300



Abb.	Bestell-Nr.	Beschreibung	Gerätetyp	Ver.-Nr.
1	101096	Gashahn CH110001	704,706, TPF706S,	932500
2	110064	Knebel	CC_GS, CF_GS,	932600
3	110066	Stift	CA4GS, TPF6GS (Sehr Alte Ausführg.)	932700



Abb.	Bestell-Nr.	Beschreibung	Gerätetyp	Vergl.-Nr.
1	102034	Thermoelement, 600mm	PCG41/61	1206400
2	101693	Gashahn	PCGD41/61	10.33027800
3	110405	Knebel	CFG70/101	10.31500200 10.31501300
				10.36700500



Abb.	Best.-Nr.	Beschreibung	Gerätetyp	Ver.-Nr.
1	103020	Brennerdeckel, 80mm		1315600 1315612
2	104030	Brennertulpe	C70-_G/ GFG/ GFE C9V-_G/GS C9F-_G/GS	1315412 1315422
3	104033	Brennerpfeife	C9SB- 4GS T9 - GS	1315200 1315212
4	105051	Mischhülse	C9FE- GS (1.-+2.Generation)	1314700
5	105052	Düsenstock		1306400 1306600



Abb.	Bestell-Nr.	Beschreibung	Gerätetyp	V.-Nr.
1	100089	Zündbrenner	704, 706, TPF706, 704S, 706S, TPF706S, CC_G, CF_GT, CA4G, TPF6GT	432600
2	101443	Gashahn PEL ohne Züandsicherung	704,706, TPF706, CC_G, CF_GT, CA4G, TPF6GT	673800
3	110364	Knebel		862800
4	110601	Symbol		



Abb.	B.-Nr.	Beschreibung	Gerätetyp	Ver.-Nr.
1	103021	Brennerdeckel, 110mm	C70-G/GFG/GFE*,	1315700
2	104031	Brennertulpe	C9V-_G/GS*,	1315512
3	104034	Brennerpfeife	C9F-_G/GS, C9SB-4GS*,	1315312
4	105051	Mischhülse	T9-_-GS*	1314700
5	105052	Düsenstock	* 1.Generation	1306400

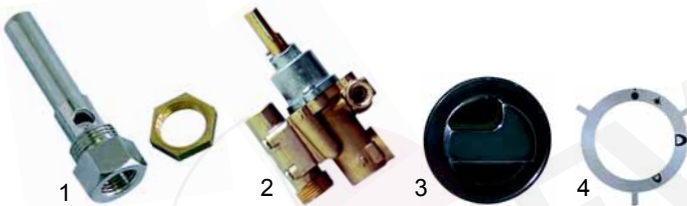

Abb.	Bestell-Nr.	Beschreibung	Gerätetyp	Vergl.-Nr.
1	102054	Thermoelement 320mm		641400
1	102056	Thermoelement 600mm	704,706, TPF706S,	641300
2	101089	Gashahn PEL mit Zünd- sicherung	CC_GS, CF_GS, CA4GS, TPF6GS	1093600 1093700
3	110364	Knebel		862800
4	110601	Symbol		



Abb.	Best.-Nr.	Beschreibung	Gerätetyp	Ver.-Nr.
1	103021	Brennerdeckel, 110mm	C70-G/GFG/GFE*,	1315712
2	104031	Brennertulpe	C9V-_G/GS*, C9F-_G/GS,	1315522
3	103151	Brennerring	C9SB-4GS*,	1893300
4	103150	Brennerpfeife	T9-_-GS*,	1892500
5	105051	Mischhülse	C9FE-_GS	1314700
6	105052	Düsenstock	* 2. Generation	1306600

M
Passend für Mareno



Abb.	Best.-Nr.	Beschreibung	Gerätetyp	Ver.-Nr.
1	103022	Brennerdeckel, 120mm	C9V- _G/GS*, C9F- _G/GS*, C9SB- 4G/GS*, T9- _G/GS*	1316000
2	104032	Brennertulpe		1315912
3	104035	Brennerpfeife		1315800
4	105051	Mischhülse	* 1. Generation	1314700
5	105052	Düsenstock		1306600



Abb.	Best.-Nr.	Beschreibung	Gerätetyp	Ver.-Nr.
1	103022	Brennerdeckel, 120mm	C9V- _G/GS*, C9F- _G/GS*, C9SB- 4G/GS*, T9- _G/GS*	1316012
2	104032	Brennertulpe		1315922
3	103150	Brennerpfeife		1315812
4	105051	Mischhülse	* 2. Generation	1314700
5	105052	Düsenstock		1306600



Abb.	Best.-Nr.	Beschreibung	Gerätetyp	Ver.-Nr.
1	100838	Zündleitung		1314600
2	100890	Halter		1706100
3	100885	Mischhülse	Universal, 1. Generation	1324900
4	100883	Zündbrenner		1314800
5	102054	Thermoelement, 320mm		641400
5	102056	Thermoelement, 600mm		641300



Abb.	Best.-Nr.	Beschreibung	Gerätetyp	Ver.-Nr.
1	101095	Gashahn PEL21	C70- _G, C70- _GFG,	1700200
2	110363	Knebel	C70- _GFE	1623300
3	110601	Symbol	* 1. Generation	

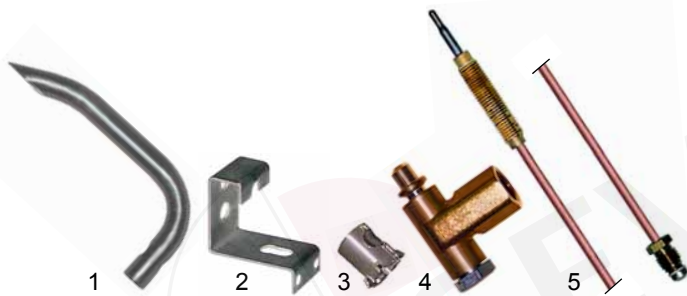

Abb.	Bestell-Nr.	Beschreibung	Gerätetyp	Vergleichs-Nr.
1	101443	Gashahn PEL22, ohne Zündflamme	C9- _G 1. Generation	1337600
2	101089	Gashahn PEL22, mit Zündflamme	C9- _GS 1. Generation	1337200
3	110388	Knebel	C9- _G, C9- _GS	1322400
4	110620	Symbol		



Abb.	Bestell-Nr.	Beschreibung	Gerätetyp	Ver.-Nr.
1	100095	Zündbrenner		1887700
2	100701	Zündkerze	Universal, 2. Generation	1888300
3	100019	Zündkabel		1950300
4	100009	Piezozünder		1936100
5	102042	Thermoelement, 850mm		1916000



Abb.	Bestell-Nr.	Beschreibung	Gerätetyp	Vergleichs-Nr.
1	101397	Gashahn PEL21	C70-, C9- 2. Generation	1888700 1888800 1888900
2	110363	Knebel	C70- 2. Generation	1841000
3	110601	Symbol		
4	110387	Knebel	C9- 2. Generation	1893500
5	110620	Symbol		



Abb.	Bestell-Nr.	Beschreibung	Gerätetyp	Vergl.-Nr.
1	105248	Brennerdeckel, 3,5kW		CM264200 1032501422
2	105249	Brennertasse	C7- _GS, C7FG- _GS, C7FE- _GS (Protagonista)	CM264000
3	103146	Brennerpfeife		1032101200
4	103148	Dichtung		1036607800
5	105230	Düsenstock		1033717200
6	105336	Luftmischer		1044229212



Abb.	Bestell-Nr.	Beschreibung	Gerätetyp	Vergl.-Nr.
1	105259	Brennerdeckel, 5,5kW		1032501622 CM264300
2	105262	Brennertasse	C7- GS,	CM264100
3	103147	Brennerpfeife	C7FG- GS,	1032101300
4	103149	Dichtung	C7FE- GS (Protagonista)	1036607900
5	105230	Düsenstock		1033717200
6	105336	Luftmischer		1044229212



Abb.	B.-Nr.	Beschreibung	Gerätetyp	Vergl.-Nr.
1	105268	Brennerdeckel, 110mm	C7- G, C7FG- G,	CM027100
2	105269	Brennertulpe	C7-FE- G,	CM005901
3	105272	Brennerpfeife	C9- G/GS,	CM043000
4	105267	Düsenstock	C9FE- G/GS,	1711800
5	105051	Luftmischer	C9- GP, C9FGM-12G	1314700



Abb.	Bestell-Nr.	Beschreibung	Gerätetyp	Vergleichs-Nr.
1	100082	Zündbrenner	C7- GS,	1032501300
2	101860	Mutter, M8x1	C7FG- GS,	1032514900
3	100834	Pilzkopf	C7FE- GS (Protagonista)	1033717300



Abb.	B.-Nr.	Beschreibung	Gerätetyp	Vergl.-Nr.
1	105273	Brennerdeckel, 120mm	C7- G, C7FG- G,	CM027200
2	105274	Brennertulpe	C7-FE- G,	CM006502
3	105275	Brennerpfeife	C9- G/GS,	CM043100
4	105267	Düsenstock	C9FE- G/GS,	1711800
5	105051	Luftmischer	C9- GP, C9FGM-12G	1314700



Abb.	Bestell-Nr.	Beschreibung	Gerätetyp	Vergleichs-Nr.
1	102042	Thermoelement, 850mm	C7- GS,	1916000
2	101397	Gashahn	C7FG- GS,	1888700
3	110894	Knebel	C7FE- GS (Protagonista)	CM061700



Abb.	Bestell-Nr.	Beschreibung	Gerätetyp	Vergl.-Nr.
1	100095	Zündbrenner	C7- G, C7FG- G,	1887700
2	100701	Zündkerze	C7-FE- G,	1888300
3	100195	Zündkabel	C9- G/GS,	1950324
4	100009	Piezozünder	C9FE- G/GS,	1936100
			C9- GP, C9FGM-12G	



Abb.	B.-Nr.	Beschreibung	Gerätetyp	Vergl.-Nr.
1	105263	Brennerdeckel, 80mm	C7- G, C7FG- G,	CM027600
2	105265	Brennertulpe	C7-FE- G,	CM006001
3	105266	Brennerpfeife	C9- G/GS,	CM042900
4	105267	Düsenstock	C9FE- G/GS,	1781800
5	105051	Luftmischer	C9- GP, C9FGM-12G	1314700



Abb.	Best.-Nr.	Beschreibung	Gerätetyp	Ver.-Nr.
1	102042	Thermoelement, 850mm	C7- G, C7FG- G,	1916000
2	101397	Gashahn	C7-FE- G,	1888700
			C9- G/GS,	1888800
			C9FE- G/GS,	1888900
			C9- GP, C9FGM-12G	CM061700

M Offene Kochstellen (Glühplatten)



Abb.	Best.-Nr.	Beschreibung	Gerätetyp	Vergl.-Nr.
1	105042	Brennerdeckel	T70___, T9V___, T9F___, T7___, T9___	1315000 1316400
2	105041	Brennertasse	T70___, T9V___, T9F___	1316300
3	105484	Brennertasse	T9___ (Protagonista)	CM0005004



Abb.	Best.-Nr.	Beschreibung	Gerätetyp	Vergl.-Nr.
1	105485	Brenner	T7___ (Protagonista)	CM002900
2	n.m.l.	Gashahn, CH330		745700
3	101630	Gashahn, PEL23, Alternative	TPF___GI/GS, TPF706	745700



Abb.	Bestell-Nr.	Beschreibung	Gerätetyp	Vergl.-Nr.
1	101086	Gashahn PEL22	T70-7G, T70-7GFG,	1337200
2	110364	Knebel	T70-11GFG	1842000
3	110601	Symbol	(alte Serien)	1842000

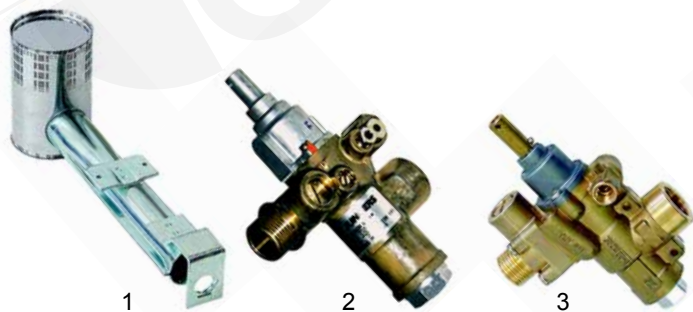

Abb.	Best.-ell-Nr.	Beschreibung	Gerätetyp	Vergl.-Nr.
1	101093	Gashahn PEL23	T9F-4G/6GS,	1345300
2	110388	Knebel	T9V-4G/6GS (alte Serien)	1322200
3	110620	Symbol		1322300

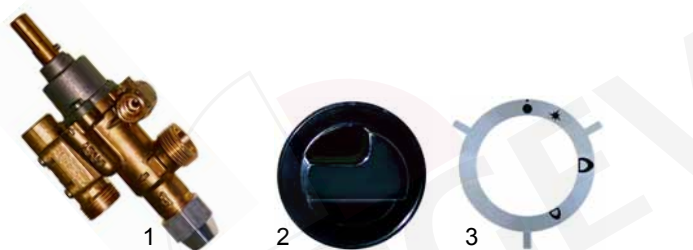

Abb.	Best.-Nr.	Beschreibung	Gerätetyp	Ver.-Nr.
1	101089	Gashahn PEL22	T70-7G, T70-7GFG,	1888600
2	110364	Knebel	T70-11GFG, T9V-4G,	1840900
3	110601	Symbol	T9F-4G/6GS (neue Serie)	1842000



Abb.	Best.-Nr.	Beschreibung	Gerätetyp	Ver.-Nr.
1	101089	Gashahn	T7-___, T9-___, T12-___ (Serie Protagonista)	1888600
2	110993	Knebel		CM061600



Abb.	Best.-Nr.	Beschreibung	Gerätetyp	Ver.-Nr.
1	100073	Zündbrenner		509900
2	100703	Zündkerze		636700
3	102227	Thermoelement, 600mm	TPF-706, TPF-GI/GS	641600
4	100007	Piezozünder	(bis Nr. 150981)	224311
5	100026	Zündkabel		548300



Abb.	Best.-Nr.	Beschreibung	Gerätetyp	Ver.-Nr.
1	100046	Zündbrenner	TPF-___GI/GS (ab Nr. 160981),	1040511
2	100706	Zündkerze	T70-7G/GGFG,	224211
3	102041	Thermoelement, 600mm	T70-11GFG, T9F4G/GS, T9V-4G/GS	90520

Offene Kochstellen (Elektro)



Abb.	B.-Nr.	Beschreibung	Gerätetyp	Vergl.-Nr.
1	490014	1500W/230V (180mm)	PCE_, CFE_, C70- _E, C70-__EFE	1037040900 1037044000 1641600 1839813
2	490018	2000W/230V (220mm)		1037079100 1037043900 1647013 1641500
2	490020	2600W/230V (220mm)	C70-__E/EFE, C7-__EC, C7FE-8E/EC	1832313
3	490066	2600W/230V (220x220mm)	C70-__EFEQ	1712913



Abb.	B.-Nr.	Beschreibung	Gerätetyp	V.-Nr.
1	490088	2500W/400V (300x300mm)	CF-__E, CC-__E, CA-__E	279111
1	490090	4000W/400V (300x300mm)		783700
2	490070	3000W/230V (300x300mm)	C9V-__E, C9F-__E, C9-__E/EC, C9FE-8E/EC	1937100 1340800 1937300 1340900
2	490073	3000W/400V (300x300mm)	C9V-__E, C9F-__E, C9-__E/EC, C9FE-8E/EC	1937200
2	490074	4000W/400V (300x300mm)		1937400

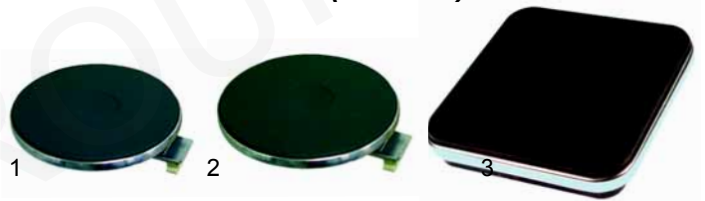

Abb.	B.-Nr.	Beschreibung	Gerätetyp	Vergl.-Nr.
1	300025	Siebertaktschalter	PCE_, CFE_, C70-E/EFE/EFEQ, C9V-__E (400V Platte), C9F-__E, C7-__EC, C7FE8E/EC, C9-__E/EC, C9FE8E/EC	1037033100 1616100
2	110405	Knebel	PCE_, CFE_	1036700500
3	110408	Knebel		1036702200

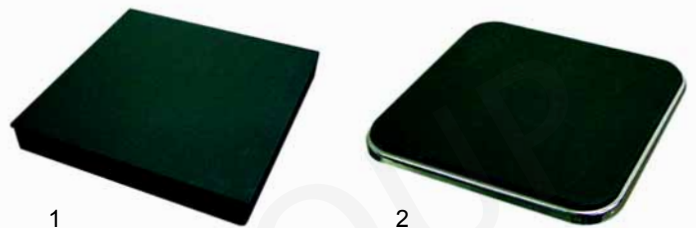

Abb.	Best.-Nr.	Beschreibung	Gerätetyp	V.-Nr.
1	102011	Verlängerung, 400mm	T9-4G/GS, T9V-4G/GS, TPF-__GT/GS (ab Nr. 160981)	933400
2	100003	Piezozünder	TPF-__GT/GS (ab Nr. 160981), T70-7G/GGFG,	986000
3	100199	Zündkabel	T70-11GFG, T9F4G/GS, T9V-4G/GS	1152500 1152600 1088900

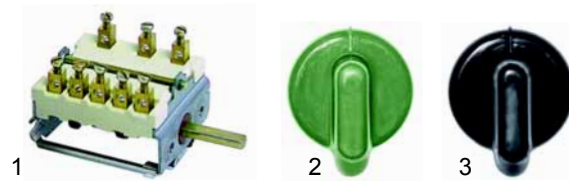

Abb.	Best.-Nr.	Beschreibung	Gerätetyp	V.-Nr.
1	100859	Zündbrenner		1887700
2	100701	Zündkerze	T70-7G/GFG, T70-11GFG,	1888300
3	102042	Thermoelement, 850mm	T9F-4G/6GS, T9V-4G/6G	1916000
4	100009	Piezozünder		1936100
5	100186	Zündkabel	T70-Serie	1936300
6	100019	Zündkabel	T9F/T9V-Serie	1936400



Abb.	Best.-Nr.	Beschreibung	Gerätetyp	Ver.-Nr.
1	100050	Zündbrenner		CM029000
2	100701	Zündkerze		1949900
3	102042	Thermoelement, 850mm	T7-__, T9-__, T12-__ (Serie Protagonista)	CM029100
4	100009	Piezozünder		1936100
5	100186	Zündkabel		1936300



Abb.	Bestell-Nr.	Beschreibung	Gerätetyp	Vergl.-Nr.
1	110362	Knebel	PCE, CFE	1036700900
2	110606	Symbol		1039107300
3	110360	Knebel	C70-__E/EFE/EFEQ	18407000
4	110606	Symbol		18402000



Abb.	B.-Nr.	Beschreibung	Gerätetyp	Vergl.-Nr.
1	110386	Knebel	C9V-__E (400V Platte), C9F-__E (400V Platte)	1508100
2	110626	Symbol		1322700
3	110994	Knebel	C7-__EC, C7FE8E/EC, C9-__E/EC, C9FE8E/EC	CM062100

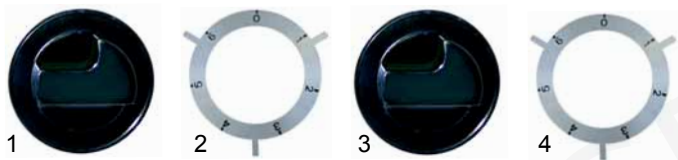

Abb.	B.-Nr.	Beschreibung	Gerätetyp	V.-Nr.
1	300103	Viertaktschalter	CA-__E, CC-__E, CF-__E, C9V-__E (230V Platte), C9F-__E (230V Platte)	501400
2	110386	Knebel		1508100
3	110626	Symbol		1322700



Abb.	Best.-Nr.	Beschreibung	Gerätetyp	Vergl.-Nr.
1	359159	Signallampe (gelb)	CA-__E, CC-__E, CF-__E, C9V-__E, C9F-__E	912800
2	359139	Signallampe (grün)	PCE__, CFE__	1037300800 1037300810
3	359140	Signallampe (gelb)	C7-__EC, C7FE8E/ EC, C9-__EC, C9FE8E/EC	1037300910
4	359142	Signallampe (grün)	C70-__E/EFE/EFEQ	21016199
5	359143	Signallampe (gelb)	C9V-__E, C9F-__E	1819900

Offene Kochstellen (Ceranfelder)



Abb.	Bestell-Nr.	Beschreibung	Gerätetyp	Vergleichs-Nr.
1	490116	1200W/230V		1037309600 1037309613
2	490113	1800W/230V	PCVE-__, CFVE-60	1037309000 1037309013
3	380015	Energieregler		1037110113
4	359139	Signallampe		1037300810



Abb.	Bestell-Nr.	Beschreibung	Gerätetyp	Vergleichs-Nr.
1	110405	Knebel		1036700500
2	110408	Knebel		1036702200
3	110362	Knebel	PCVE-__, CFVE-__	1036700900
4	110608	Symbol		1039115600

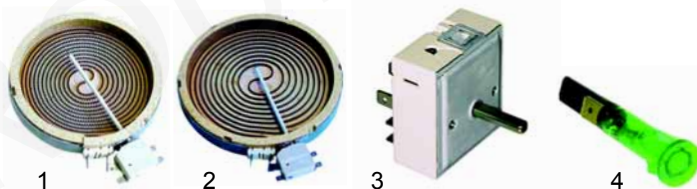

Abb.	Bestell-Nr.	Beschreibung	Gerätetyp	Vergleichs-Nr.
1	416963	2400W/230V		1037308900 CR0419950
2	380016	Energieregler (50.27021.600)	PCVE-__, CFVE-__	1037108713
3	110362	Knebel		1036700900
4	110609	Symbol		1039115700

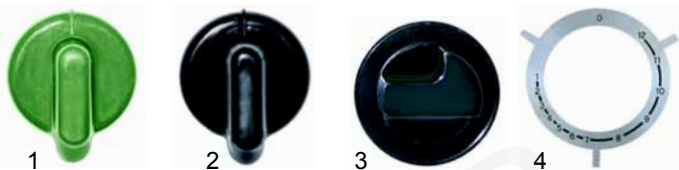

Abb.	Bestell-Nr.	Beschreibung	Gerätetyp	Vergleichs-Nr.
1	490115	3400W/230V		CM189500
2	380027	Energieregler	V9-4E, V9-8E	CM189600 CM293900
3	110995	Knebel		CM062500
4	359140	Signallampe		1037300910



Abb.	Best.-Nr.	Beschreibung	Gerätetyp	Vergl.-Nr.
1	359327	Restwärmanzeige, 1-fach	Universal	1037309300
				1037309310
2	359326	Restwärmanzeige, 4-fach		1037309400

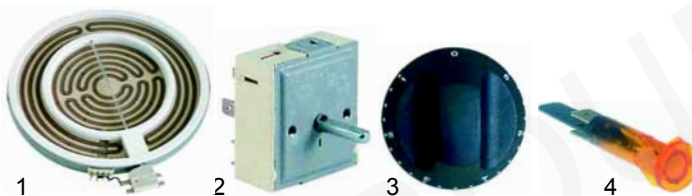

Abb.	Best.-Nr.	Beschreibung	Gerätetyp	V.-Nr.
1	101137	Abdeckkappe	CF-__GT/GS	24020199
2	101136	Abdeckkappe mit Piezozünder		24020299
3	110068	Knebel		24020399

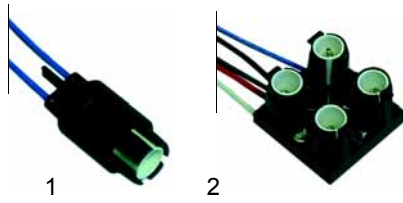

Abb.	Best.-Nr.	Beschreibung	Gerätetyp	Vergl.-Nr.
1	693116	Ceranfeld (510x348mm)	PCVE-40	1041711623
2	693117	Ceranfeld (510x548mm)	PCVE-60	1041711723



Abb.	Bestell-Nr.	Beschreibung	Gerätetyp	Vergleichs-Nr.
1	100007	Piezozünder	CF-__GT/GS	224311
2	100003	Piezozünder		986000
3	100001	Piezozünder		

Backöfen (Gas)

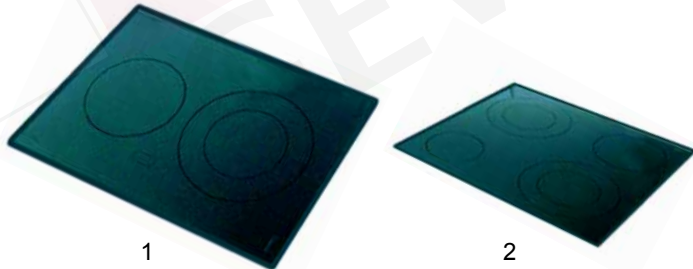

Abb.	Best.-Nr.	Beschreibung	Gerätetyp	Vergl.-Nr.
1	105486	Brenner	CFG-__, C70-__GFG, T70-__GFG	1664300
2	105487	Brenner	C9F-__, C9FP-__, T9F-__, T9FP-__	1305024
3	105488	Brenner	C__FG-__G, C9FG-8GP, T__FG-__G	CM021402



Abb.	Bestell-Nr.	Beschreibung	Gerätetyp	Vergleichs-Nr.
1	101173	Gasthermostat	CFG-__, C70-__GFG, T70-__GFG	1661300
				1699400
				1031500000
2	110406	Knebel		1036700300
3	110361	Knebel		1036703300
4	110603	Symbol		1930400



Abb.	Bestell-Nr.	Beschreibung	Gerätetyp	Vergl.-Nr.
1	101105	Babysitregler	704, 704S, 706, 706S/AS, TPF706/706S	508311
2	n.m.l.	Knebel		24020599
3	101132	Minisitregler	CF-__GT/GS	410622 671111



Abb.	B.-Nr.	Beschreibung	Gerätetyp	Ver.-Nr.
1	101132	Minisitregler	C9F-__G/GS, T9F-4G/GS	1393100
				1307200
				1393600
2	101136	Abdeckkappe mit Piezozünder		1393500
3	110068	Knebel		986000
4	100003	Piezozünder		

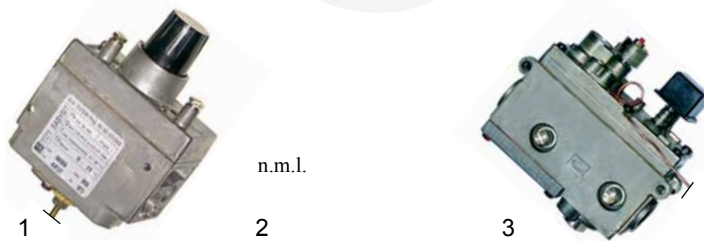

Abb.	Bestell-Nr.	Beschreibung	Gerätetyp	Vergleichs-Nr.
1	101125	Eurositregler		1887600
2	101392	Adapter	C9F-__	1868600
3	101390	Achse	C9FP-__	1905525
4	110386	Knebel	T9F-__	1508100
5	110623	Symbol	T9FP-__	1889800

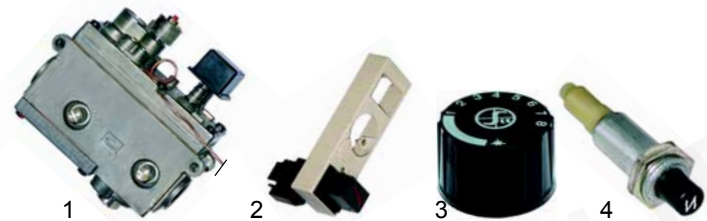

Abb.	Bestell-Nr.	Beschreibung	Gerätetyp	Vergleichs-Nr.
1	101125	Eurositregler	C7FG-__G,	1887600
2	101816	Adapter	C9FG-__G,	CM057701
3	110996	Knebel	C9FG-8GP,	CM058001
4	100009	Piezozünder	T7FG-__G,	1936100
			T9FG-__G	



Abb.	Best.-Nr.	Beschreibung	Gerätetyp	Ver.-Nr.
1	100073	Zündbrenner	704, 704S, 706, 706S,	578800
			706AS, TPF-706/706S	411111
2	100703	Zündkerze		636700
3	102044	Thermoelement, 1200mm	704, 704S, 706, 706S,	263800
			706AS, TPF-706/706S	
3	102225	Thermoelement, 220mm	CF-__GS/GT	933300
4	102011	Verlängerung, 400mm		933400



Abb.	Best.-Nr.	Beschreibung	Gerätetyp	Ver.-Nr.
1	102059	Thermoelement		1665000
2	100703	Zündkerze	C70-__GFG,	636700
3	100003	Piezozünder	T70-__GFG, CFG-__	986000



Abb.	Bestell-Nr.	Beschreibung	Gerätetyp	Ver.-Nr.
1	100106	Zündbrenner		1315100
2	100706	Zündkerze	C9F-__G/GS,	224211
3	102041	Thermoelement	T9F-__G/GS	90520
4	102011	Verlängerung, 400mm		933400

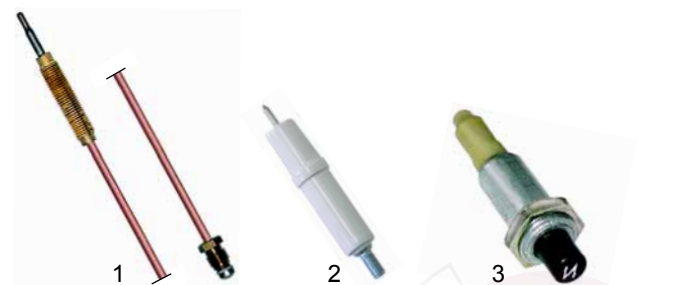

Abb.	Bestell-Nr.	Beschreibung	Gerätetyp	Ver.-Nr.
1	100859	Zündbrenner		1887700
2	100701	Zündkerze	C9F-__, C9FP-__,	1888300
3	102042	Thermoelement	T9F-__, T9FP-__	1916000
4	100019	Zündkabel		1936400



Abb.	Best.-Nr.	Beschreibung	Gerätetyp	Vergl.-Nr.
1	100109	Zündbrenner	C7FG-__G,	CM040800
2	100701	Zündkerze	C9FG-__G,	1888300
3	102042	Thermoelement, 850mm	C9FG-8GP,	CM029100
			T7FG-__G,	
4	100019	Zündkabel, 900mm	T9FG-__G	1936400

Backöfen (Elektro)

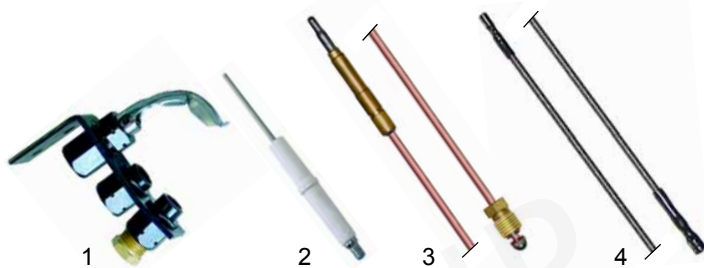

Abb.	Bestell-Nr.	Beschreibung	Gerätetyp	Vergl.-Nr.
1	415968	1200W/230V		1037302400
2	415967	2600W/2x230V	FOE-60M	1037302300
3	415966	2500W/230V	CFE-60,	1037300200
			CFGE-61,	1037300400
			FOE-60M	



Abb.	Best.-Nr.	Beschreibung	Gerätetyp	Ver.-Nr.
1	415972	1500W/230V	C70-__EFE/EFEQ	1890600
2	415088	1000W/230V	CF-4E, C9F-__E, C9FE-__GS	213443
3	416808	1000W/230V	C7FE-8E/EC, C7FE-G, C9FE-8E/EC, C9FE-G	CM018102

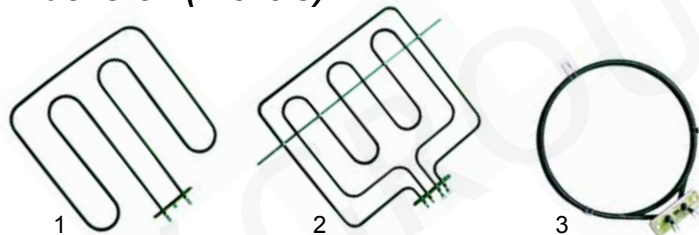

Abb.	Bestell-Nr.	Beschreibung	Gerätetyp	Vergl.-Nr.
1	n.m.l.	Thermostat, 300°C		425900
2	375192	Thermostat, 300°C	CFE-__E	1309115
3	300002	Vorsatzschalter		710300

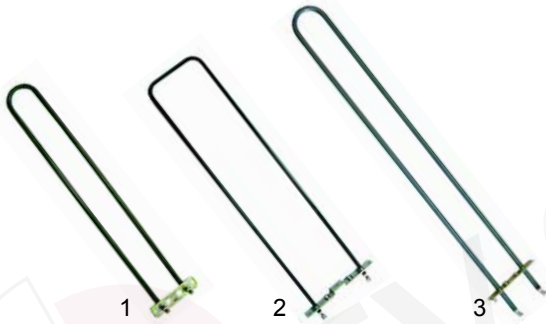

Abb.	Best.-Nr.	Beschreibung	Gerätetyp	Vergl.-Nr.
1	375002	Thermostat, 50-300°C	CFGE-, CFE-__, CFVE-, FOE-60M	1037102300
2	300080	Vorsatzschalter	CFGE-, CFE-, CFVE-	1037033200 710300
3	350036	Zeituhr 60min.	CFGE-, CFE-, CFVE-, FOE-60M	1031006400
4	345708	Backofenumschalter	FOE-60M	1037103800

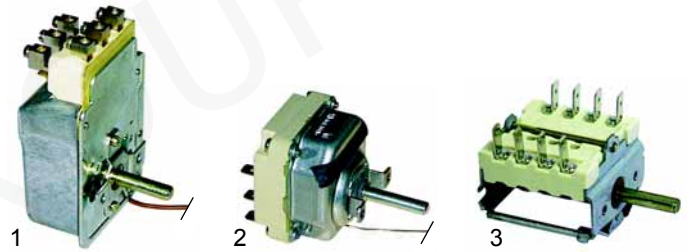

Abb.	Bestell-Nr.	Beschreibung	Gerätetyp	Vergl.-Nr.
1	110360	Knebel	C70-EFE, C70-__FE,	1840700 1840400
2	110614	Symbol, 300°C	C70-__EFEQ, C70-__GFE	1840513
3	110616	Symbol/Backofen		

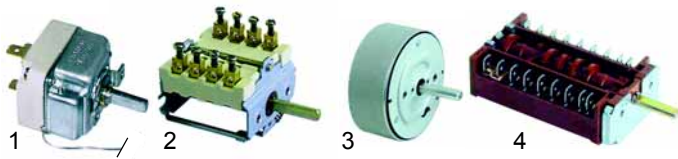

Abb.	Best.-Nr.	Beschreibung	Gerätetyp	Vergl.-Nr.
1	110405	Knebel	CFGE-CFE-, CFVE-, FOE-60M	1036700500 1036702200
2	110408	Knebel		
3	110421	Knebel, 60min	CFGE-CFE-, CFVE-	1031020000
4	110422	Knebel, 300°C		1031019900

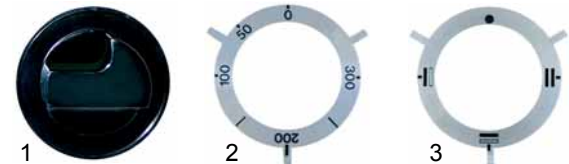

Abb.	Bestell-Nr.	Beschreibung	Gerätetyp	Vergl.-Nr.
1	110386	Knebel		1508100
2	110631	Symbol, 300°C	C9F-__E, C9FE-GS	1323300 1323500 1323513
3	110997	Symbol/Backofen		



Abb.	Bestell-Nr.	Beschreibung	Gerätetyp	Vergl.-Nr.
1	110360	Knebel	CF-__E	18407000 18404000
2	110614	Symbol		
3	110998	Knebel/Thermostat	C__FE-8E/EC, C__FE-__G	CM059800 CM059700
4	110999	Knebel/Backofen	(Protagonista)	

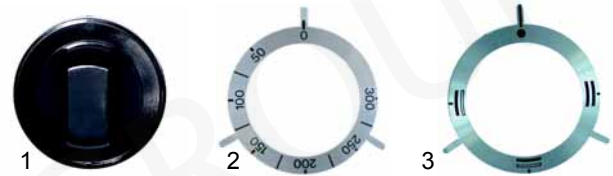

Abb.	Best.-Nr.	Beschreibung	Gerätetyp	V.-Nr.
1	375192	Thermostat, 50-300°C	C70-__EFE, C70-__EFEQ, C70-__FE, C9F-__E,	1309100 1309115
2	550060	Bügel	C9FE-__GS,	921200
3	300002	Vorsatzschalter	C__FE-8E/EC, C__FE-__G	710300 1309000
4	300081	Umschalter		

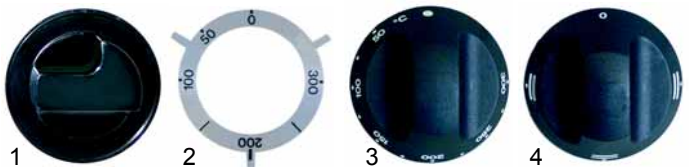

Abb.	B.-Nr.	Beschreibung	Gerätetyp	Vergl.-Nr.
1	359160	Signallampe/grün	CF-__FE	1230300
2	359159	Signallampe/gelb		912800
3	359164	Signallampe/doppelt	C9F-__E, C9FE-__GS	1314400
4	359139	Signallampe/grün	CFGE-, CFE-__, CFVE-, EOE-60M,	1037300800 1037300810
5	359140	Signallampe/gelb	C__FE-__E/EC, C__FE-__G	1037300900 1037300910

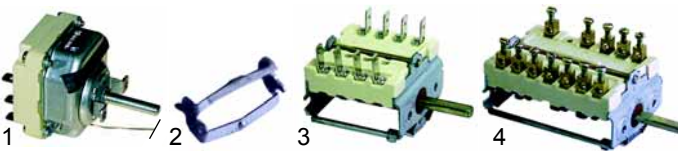

Abb.	B.-Nr.	Beschreibung	Gerätetyp	Ver.-Nr.
1	359142	Signallampe/grün	C70-__EFE, C70-__EFEQ, C70-__GFE	21016199
2	359143	Signallampe/gelb		21016299
3	359142	Signallampe/grün	C9F-__E, C9FE-__GS	1819800
4	359143	Signallampe/gelb		1819900



Abb.	Best.-Nr.	Beschreibung	Gerätetyp	Ver.-Nr.
1	375187	Sicherheitsthermostat, 360°C	Universal	1878500
2	359718	Backofenlampe, kpl.	CFE-__, CFVE-__, CFGE-__	1037300100

Backöfen (Mechanik)



Abb.	Bestell-Nr.	Beschreibung	Gerätetyp	Vergl.-Nr.
1	700014	Scharnier/rechts		1031105500
2	700013	Scharnier/links	CFE-60, CFGE-60	1031102000
3	700003	Gegenstück		1031106000

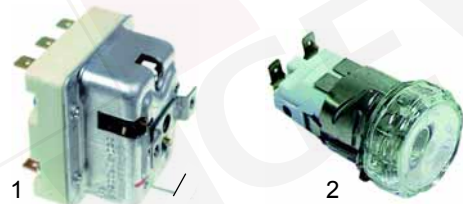

Abb.	Bestell-Nr.	Beschreibung	Gerätetyp	Vergleichs-Nr.
1	700015	Scharnier/rechts		1031105800
2	700016	Scharnier/links	FOE-60	1031105900
3	700003	Gegenstück		1031106000

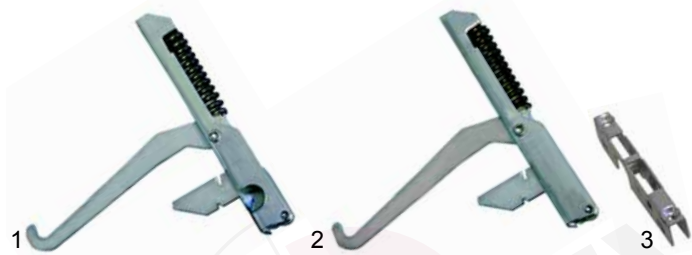

Abb.	Bestell-Nr.	Beschreibung	Gerätetyp	Ver.-Nr.
1	700004	Scharnier/rechts	CE70-__EFE/EFEQ, CE70-__FE/GFE, C9F-__G/GS/E, T9F-__G, T9FP-__, C9FP-__	1304600
2	700005	Scharnier/links		1304700
3	700001	Gegenstück		1304500



Abb.	Bestell-Nr.	Beschreibung	Gerätetyp	Ver.-Nr.
1	700164	Scharnier	C__FE-__E/EC/G, C__FG-__G, T__FG-__G	CM041300
2	700001	Gegenstück		1304500

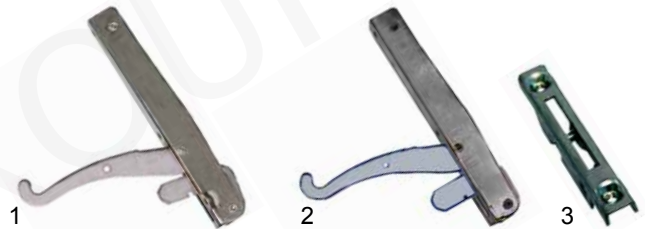

Abb.	Bestell-Nr.	Beschreibung	Gerätetyp	Vergl.-Nr.
1	900404	Dichtung	CFGE-__, CFE-__, CFVE-	1036608000
2	900405	Dichtung		1036101400



Abb.	B.-Nr.	Beschreibung	Gerätetyp	V.-Nr.
1	900104	Dichtung/seitlich, 355mm		1662814 1662800
2	514003	Feder/seitlich, 370mm	C70-__EFE/EFEQ, C70-__FE/GFE, C70-__GFG, T70-__GFG	1662614 1662600
3	900102	Dichtung/oben, 650mm		1706300
4	514001	Feder/oben, 655mm		1706200

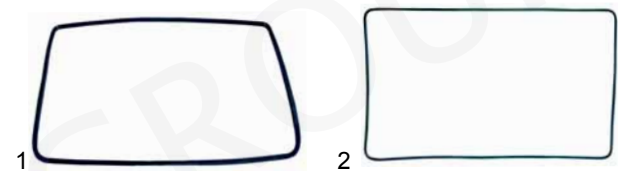

Abb.	Best.-Nr.	Beschreibung	Gerätetyp	Ver.-Nr.
1	900105	Dichtung/seitlich, 310mm	C9F- E/GS, C9FE- GS, T9F- G/GS	1336200
2	514004	Feder/seitlich, 325mm		1336000
3	900103	Dichtung/oben, 575mm		1336100
4	514002	Feder/oben, 595mm		1335900

Grillplatten (Gas)

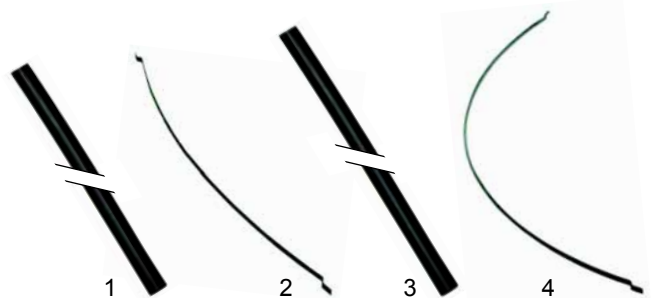

Abb.	Bestell-Nr.	Beschrbg.	Gerätetyp	Ver.-Nr.
1	104240	Brenner	FTG-__	1031501000
2	105497	Brenner	FT7-__G/GR/GRL	1729700
3	104154	Brenner	FT__G_-L70/R70/RL70, FT__G_-LC70/RC70	1685400
4	104161	Brenner	F9V- G/GR/GRL, F9SB- G/GR/GRL	1351000

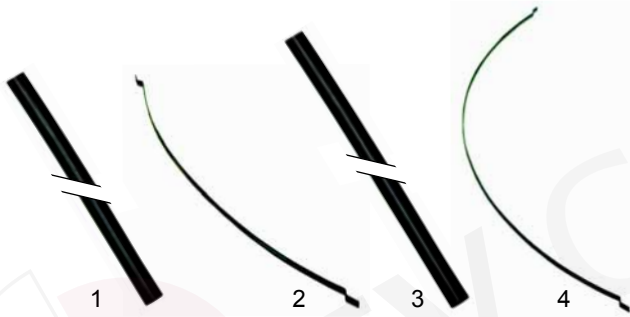

Abb.	Best.-Nr.	Beschrbg.	Gerätetyp	Ver.-Nr.
1	104153	Brenner	FT__G_-L90/R90/RL90, FT-G_-LC90/RL90	1475100
2	105490	Brenner	FT7__GL/GR/GLC/GM, FT7__GMC/GLLT/GMMT (Protagonista)	CM081302
3	105491	Brenner	FT9-__GMC/GLLT/GMMT	CM033503



Abb.	Best.-Nr.	Beschrbg.	Gerätetyp	Ver.-Nr.
1	105492	Brenner	FT7-60GL/GR/GLC/GM, FT7-60GMC/GL/LTGMMT	CM081402
2	105493	Brenner	FT9-60GL/GR/GLC/GM, FT9-60GMC/GL/LTGMMT	CM079801



Abb.	Best.-Nr.	Beschreibung	Gerätetyp	Ver.-Nr.
1	102034	Thermoelement, 450mm	FTG-__B (Alt), BIG-40/60	1033027500 1206400
2	101693	Gashahn PEL21		1031500200
3	110406	Knebel		1036700300
4	110450	Knebel		1036702300
5	110361	Knebel		1036703300
6	110601	Symbol		1039110800



Abb.	B.-Nr.	Beschreibung	Gerätetyp	Ver.-Nr.
1	102247	Thermoelement, 600mm	FTG-__B/BR/BLC (Neu)	1955500
2	101907	Gasthermostat PEL25, 280°C	FTG-__B/BR (Neu)	1031503900 1031501700
2	101906	Gasthermostat PEL25, 250°C	FTG-__BLC	1031504000
3	110406	Knebel	FTG-B/BR/BLC	1036700300
4	110450	Knebel		1036702300
5	110361	Knebel		1036703300
6	110948	Symbol		1039121600



Abb.	Best.-Nr.	Beschreibung	Gerätetyp	Vergl.-Nr.
1	102040	Thermoelement, 500mm	FT7-G, FT7-GR, FT7-GRL	641900
2	101397	Gashahn		1700500
3	110363	Knebel		1840800
4	110601	Symbol		1842000



Abb. B.-Nr.	Beschreibung	Gerätetyp	V.-Nr.
1 102041	Thermoelement, 600mm		90520
2 101089	Gashahn	F9V-__G/GR/GRL, F9SB-__G/GR/GRL	1337200
3 110388	Knebel		1022200
4 110620	Symbol		1022300



Abb. B.-Nr.	Beschreibung	Gerätetyp	Ver.-Nr.
1 102247	Thermoelement, 600mm		1950100
2 101125	Eurositregler	FT__-GLC, FT__-GMC,	1887600
3 101816	Adapter	FT__-LT/MT/RT (Protagonista)	CM057701
4 110460	Knebel		CM062401



Abb. B.-Nr.	Beschreibung	Gerätetyp	V.-Nr.
1 102042	Thermoelement, 850mm	FT__-L_/R_/RL__	1916000
2 102247	Thermoelement, 600mm	FT__-LC_/RC__	1955500
3 101125	Eurositregler		1887600
4 101392	Adapter	FT__-L_/R_/RL__	1868600
5 101390	Achse	FT__-LC_/RC__	1905525



Abb. Best.-Nr.	Beschreibung	Gerätetyp	Vergleichs-Nr.
1 100073	Zündbrenner		1031027800 509900
2 100703	Zündkerze	FTG-	1031025700 636700
3 100186	Zündkabel		1047024400 1936300
4 100013	Piezozünder, 22mm	FTG (I-Serie)	1031500600
5 100009	Piezozünder, 18mm	FFG (II-Serie)	1936100



Abb. Best.-Nr.	Beschreibung	Gerätetyp	Ver.-Nr.
1 110360	Knebel	FT__-L70/R70, FT__- RL70/LC70, FT__- RC70	1840700 1930400
2 110603	Symbol		
3 110386	Knebel	FT__-L90/R90/RL90,	1508100
4 110622	Symbol	FT__-LC90/RC90	1923300



Abb. Best.-Nr.	Beschreibung	Gerätetyp	Ver.-Nr.
1 100073	Zündbrenner		509900
2 100703	Zündkerze	FT7__-G/GR/GRL	636700
3 100199	Zündkabel, 400mm		1088300
4 100003	Piezozünder		986000



Abb. Best.-Nr.	Beschreibung	Gerätetyp	Ver.-Nr.
1 102042	Thermoelement, 850mm		CM029100
2 101397	Gashahn	FT__-GL/GR/GM (Protagonista)	1888900 1916900
3 110894	Knebel		CM061700

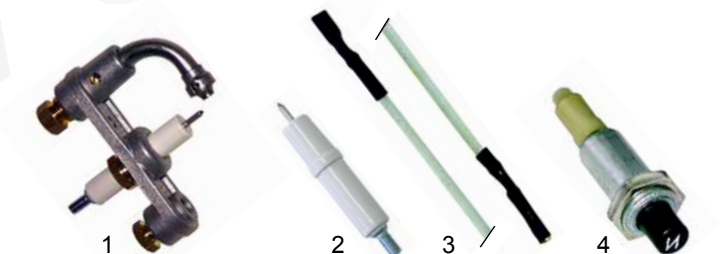

Abb. Best.-Nr.	Beschreibung	Gerätetyp	Ver.-Nr.
1 100046	Zündbrenner		1314500
2 100706	Zündkerze	F9V-__G/GR/GRL, F9SB-__G/GR/GRL	224211
3 100199	Zündkabel, 500mm		1088900
4 100003	Piezozünder		986000



Abb.	B.-Nr.	Beschreibung	Gerätetyp	V.-Nr.
1	100859	Zündbrenner	FT__-G__-L/R/RL/RC/LC70,	1887700
2	100701	Zündkerze	FT__-G__-L/R/RL/RC/LC90,	1949900
			FT__-GR/GL/GLC/GM,	1888300
3	100186	Zündkabel	FT__-GLT/GMT	1936300
4	100009	Piezozünder		1936100

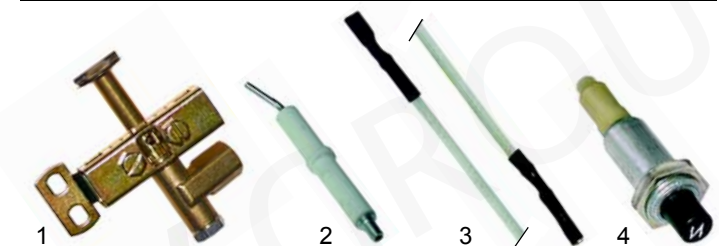

Abb.	Bestell-Nr.	Beschrbg.	Gerätetyp	Vergl.-Nr.
1	416175	1500W/230V	FT7-4EL/ER/EL, FT7-8EL/ELC/EM/EMC (700 Serie-Protagonista)	CM164800
2	416180	2200W/230V	FT-6EL/ELC/EM/EMC (700 Serie-Protagonista)	CM165100
3	415085	1400W/230V	FTC-__ (1 Serie bis Nr. 191279)	167622
4	415086	2000W/230V	FTC-__, F9V-__ (900 Serie 1+2 Serie)	1029200

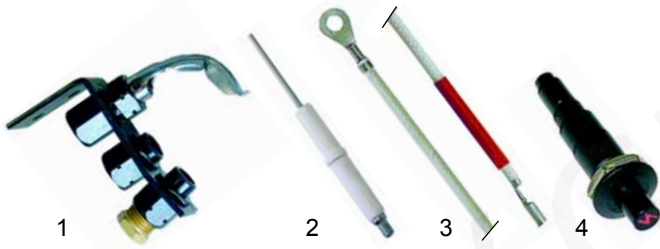

Abb.	B.-Nr.	Beschreibung	Gerätetyp	V.-Nr.
1	375357	Sicherheitsthermostat	FTG-_C	1942900
2	375187	Sicherheitsthermostat	FT_G_-LC/RC, FT__-GLC/GMC, FT__-GMT/GLT/GRT	1878500

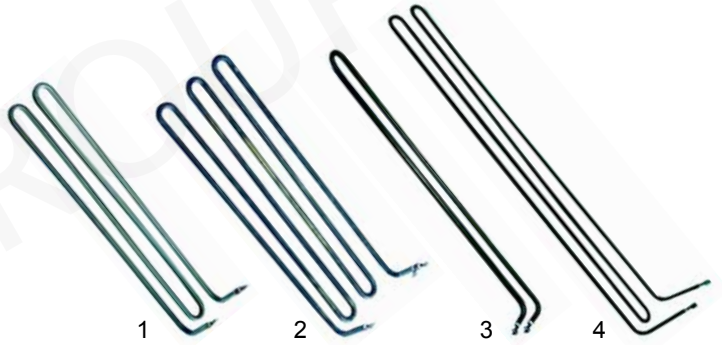

Abb.	Bestell-Nr.	Beschrbg.	Gerätetyp	Vergl.-Nr.
1	415958	1900W/230V	F9V-__ (900 III-Serie)	1941900
2	416694	2200W/230V	FT9-4EL/ELC/ER, FT9-8EL/ELC/EM/EMC (900 Serie-Protagonista)	CM164900
3	416695	3300W/230V	FT9-6EL/ELC/EM/EMC (900 Serie-Protagonista)	CM165200

Grillplatten (Elektro)

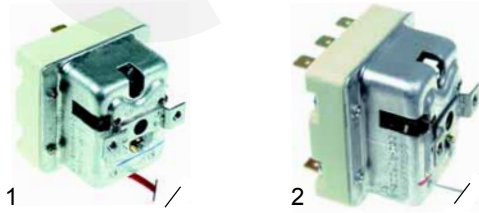

Abb.	B.-Nr.	Beschrbg.	Gerätetyp	Vergl.-Nr.
1	415076	1300W/230V	FTE-__, BIE-__ (600 Serie)	1037300700 1037300713
2	415087	1300W/230V	FTE-702/703	892800
3	415975	1800W/230V	FT7-__E/ER/ERL (700 II-Serie)	1730000
4	415982	1300W/230V	FT7-__E/ER/ERL/EC/ECRL (700 III-Serie)	1941800

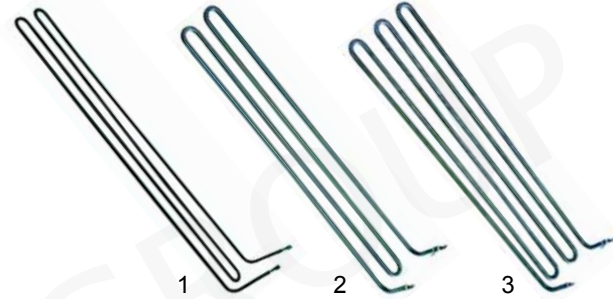

Abb.	Bestell-Nr.	Beschreibung	Gerätetyp	Vergl.-Nr.
1	375412	Thermostat	FTE-__ (600 II-Serie),	1732000 1037035200
2	550060	Bügel	FT7-__ (700 II-Serie)	1037033300
3	300080	Vorsatzschalter		1037033200

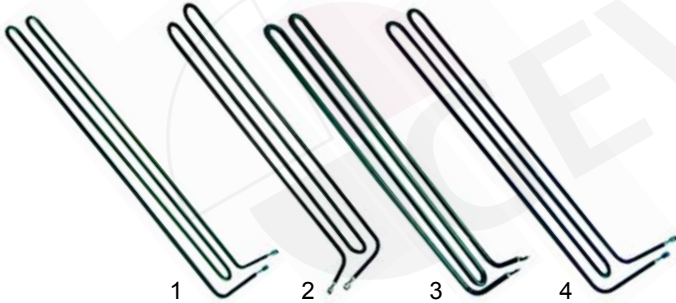

Abb.	Bestell-Nr.	Beschreibung	Gerätetyp	Vergl.-Nr.
1	110405	Knebel	FTE-__ (600 III-Serie)	1036700500
2	110408	Knebel		1036702200
3	110360	Knebel	FT7-__ (700 II-Serie)	1840700
4	110615	Symbol		1039107500



Abb.	B.-Nr.	Beschrbg.	Gerätetyp	V.-Nr.
1	n.m.l.	Thermostat	FTE-___, BTE (600 III-Serie),	425900
2	375192	Thermostat	FTE- (700 I-Serie), FT7-___ (700 III-Serie), FTC-___ (900 I-Serie), F9V-___ (900 I-Serie),	1309100 1309115
3	550060	Bügel	F9V-___ (900 Serie 2+3 Serie),	921200
4	300080	Vorsatzschalter	FT7-___ (700 Serie-Protagonista), FT9-___ (900 Serie-Protagonista)	710300



Abb.	Best.-Nr.	Beschreibung	Gerätetyp	Ver.-Nr.
1	110405	Knebel		1036700500
2	110408	Knebel	FTE-___, BTE-___	1036702200
3	110362	Knebel	(600 III-Serie)	1036700900
4	110614	Symbol		1840400

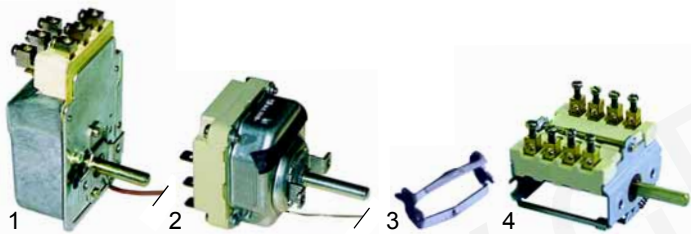

Abb.	B.-Nr.	Beschreibung	Gerätetyp	V.-Nr.
1	110360	Knebel	FTE- (700 I-Serie), FT7-___	1840700
2	110614	Symbol	(700 III-Serie), FTC-___	1840400
3	110386	Knebel	F9V-___	1508100
4	110631	Symbol	(900 Serie 2+3 Serie)	1323300

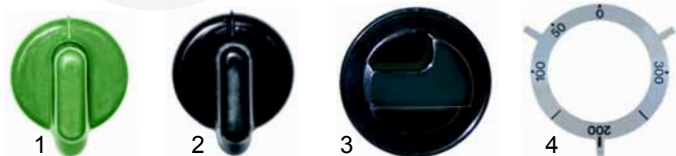

Abb.	Best.-Nr.	Beschreibung	Gerätetyp	Ver.-Nr.
1	110998	Knebel	FT7 (700 Protagonista), FT9 (900 Protagonista)	CM059800
2	375187	Sicherheitsthermostat	Universal	1878500

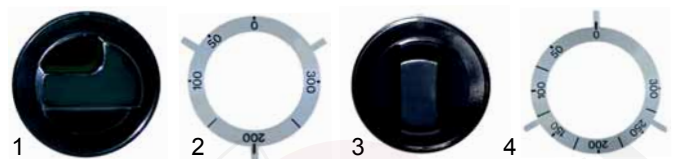

Abb.	B.-Nr.	Beschreibung	Gerätetyp	Ver.-Nr.
1	359160	Signallampe/grün	FTE- (700 Serie I-Serie), FTC- (900 Serie I-Serie), F9V- (900 Serie II-Serie)	1230300 912800
3	359139	Signallampe/grün	FTE- (600 Serie II+III Serie), BTE- (600 Serie),	1037300800 1037300810
4	359140	Signallampe/gelb	FT7- (700 III-Serie), F9V- (900 III-Serie), FT7- (700 Protagonista), FT9 (900 Protagonista)	1037300900 1037300910

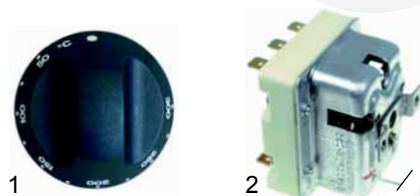

Abb.	Bestell-Nr.	Beschreibung	Gerätetyp	Vergl.-Nr.
1	359142	Signallampe/grün	FT7 (700 II-Serie)	21016199
2	359143	Signallampe/gelb		21016299

Grillplatten (Ceran)



Abb.	Bestell-Nr.	Beschreibung	Gerätetyp	Vergleichs-Nr.
1	416696	1500W/230V	FTVE-60	1037311013
2	416697	2500W/230V	FTVE-40/80	1037311213



Abb.	Bestell-Nr.	Beschreibung	Gerätetyp	Vergleichs-Nr.
1	380015	Energiregler		1037110113
2	110405	Knebel		1036700506
3	110408	Knebel	FTVE-___	1036702200
4	110362	Knebel		1036700900
5	110608	Symbol		1039115600
6	359139	Signallampe		1037300810

Lavasteingrills (Gas)

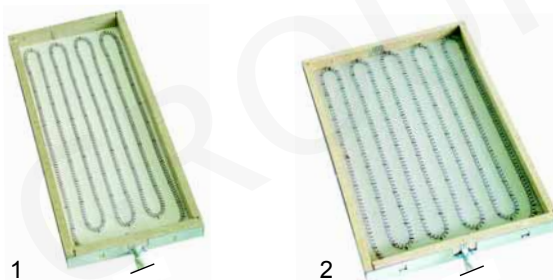

Abb.	Bestell-Nr.	Beschreibung	Gerätetyp	Vergleichs-Nr.
1	104156	Brenner	PLG-__, GB70-__, GB9-__	1031501400 1828100 1828112
2	105494	Brenner	GL7-__	CM203100
3	105495	Brenner	GL9-__	CM201900

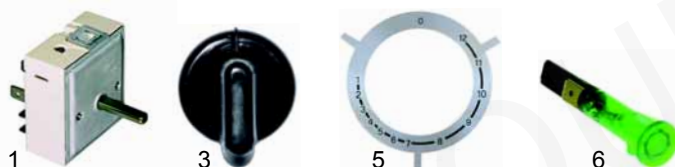

Abb.	Bestell-Nr.	Beschreibung	Gerätetyp	Vergleichs-Nr.
1	211029	Lavasteinrost	PLG-__, GB70-__, GB9-__	1041301400 1829522 1829500
2	211030	Lavasteinrost	GL7-__	CM207900
3	211031	Lavasteinrost	GL9-__	CM209400



Abb.	B.-Nr.	Beschreibung	Gerätetyp	Vergl.-Nr.
1	102034	Thermoelement, 600mm	PLG-__ (I-Serie)	1033027500
2	101693	Gashahn		1031500200
3	102042	Thermoelement, 850mm	PLG-__ (II-Serie)	1916000
4	101913	Gashahn		1031501300

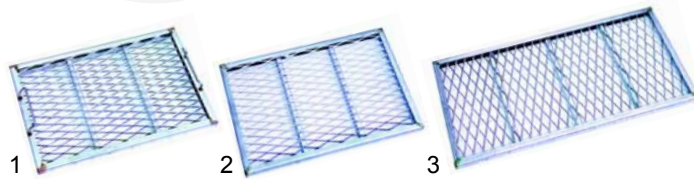

Abb.	Bestell-Nr.	Beschreibung	Gerätetyp	Vergl.-Nr.
1	110406	Knebel	PLG	1036700300
2	110450	Knebel		1036702300
3	110361	Knebel		1036703300
4	110601	Symbol		1039110800



Abb.	B.-Nr.	Beschreibung	Gerätetyp	Ver.-Nr.
1	102035	Thermoelement, 850mm	GB70- (I-Serie)	1206500
2	101095	Gashahn		1700500
3	102042	Thermoelement, 850mm	GB70- (II-Serie), GB9-	1916000
4	101397	Gashahn		1916900

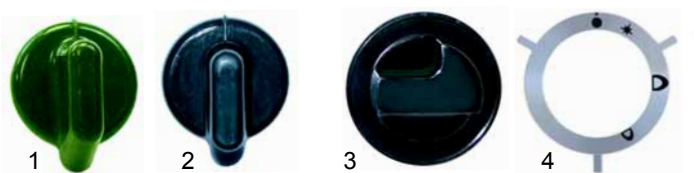

Abb.	Bestell-Nr.	Beschreibung	Gerätetyp	Vergl.-Nr.
1	110363	Knebel	GB70-	1840800
2	110601	Symbol		1842000
3	110387	Knebel	GB9-	1893400
4	110620	Symbol		1322300



Abb.	Bestell-Nr.	Beschreibung	Gerätetyp	Vergl.-Nr.
1	102042	Thermoelement	GL7-, GL9-	CM029100
2	101397	Gashahn		CM226800 1888700
3	110894	Knebel		CM061700

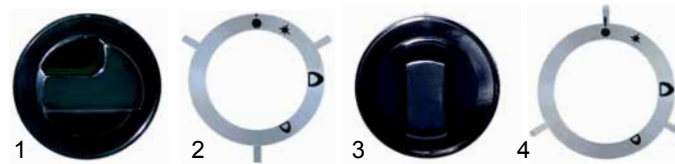

Abb.	Bestell-Nr.	Beschreibung	Gerätetyp	Vergl.-Nr.
1	100073	Zündbrenner	PLG (I-Serie)	1031027800
2	100703	Zündkerze		1031025700
3	100186	Zündkabel		1047024400
4	100013	Piezozünder		1031500600



Abb.	Bestell-Nr.	Beschreibung	Gerätetyp	Vergl.-Nr.
1	100859	Zündbrenner	PLG- (II-Serie), GB70- (II-Serie), GB9-, GL7-, GL9-	1887700
2	100701	Zündkerze		1888300
3	100186	Zündkabel		1936300
4	100009	Piezozünder		1936100

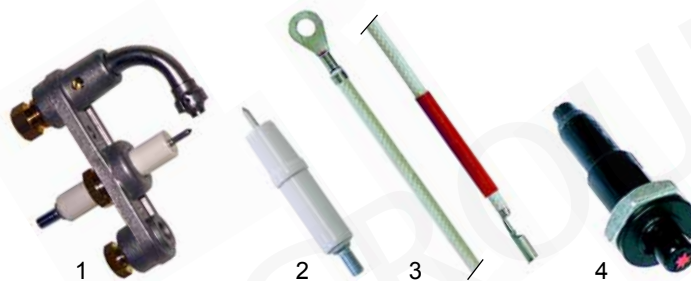

Abb.	Bestell-Nr.	Beschreibung	Gerätetyp	Vergl.-Nr.
1	100073	Zündbrenner	GB70 (I_Serie)	509900
2	100703	Zündkerze		636700
3	100199	Zündkabel		1152700
4	100003	Piezozünder		986000

Rostbräter (Elektro)



Abb.	Bestell-Nr.	Beschreibung	Gerätetyp	Vergl.-Nr.
1	415095	1500W/230V	CWE40/41, CWE60/61	1037300000
2	415965	1800W/230V	CWE42/62	1037311315
3	210152	Rost	CWE-	1032100000

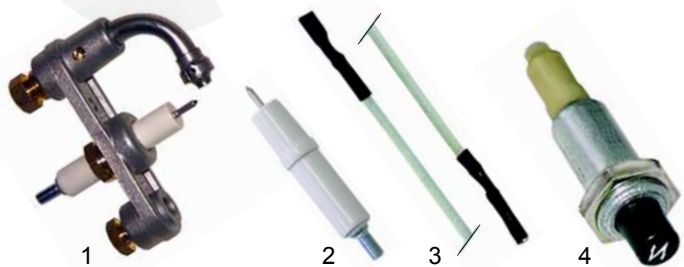

Abb.	Bestell-Nr.	Beschreibung	Gerätetyp	Vergl.-Nr.
1	375412	Thermostat		1037035200
2	550060	Bügel	CWE40, CWE60	1037033300
3	300080	Vorsatzschalter		1037033200



Abb.	Bestell-Nr.	Beschreibung	Gerätetyp	Vergl.-Nr.
1	375192	Thermostat		1309115
2	550060	Bügel	CWE42, CWE62	921200
3	300080	Vorsatzschalter		710300



Abb.	Bestell-Nr.	Beschreibung	Gerätetyp	Vergl.-Nr.
1	380015	Energieregler	CWE41, CWE61	1037035310
2	380213	Schütz		1037104800 CM187300



Abb.	Bestell-Nr.	Beschreibung	Gerätetyp	Vergleichs-Nr.
1	110463	Knebel	CWE-	1036700700
2	111500	Knebel		1036702600
3	110360	Knebel		1840700
4	110614	Symbol		1840400

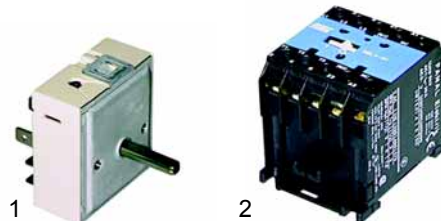

Abb.	Bestell-Nr.	Beschreibung	Gerätetyp	Vergl.-Nr.
1	375187	Sicherheitsthermostat		1878500
2	359139	Signallampe/grün	CWE-	1037300810
3	359140	Signallampe/gelb		1037300910

Bräter/ Sudpfannen (Gas)



Abb.	Bestell-Nr.	Beschreibung	Gerätetyp	Vergl.-Nr.
1	104150	Brenner	BRG40/40G	1031002300
2	102039	Thermoelement	BRG40/40G	1031500400
3	101457	Gashahn	(I-Serie)	1031027900

Bräter/Sudpfannen (Elektro)



Abb.	Bestell-Nr.	Beschreibung	Gerätetyp	Vergleichs-Nr.
1	102034	Thermoelement	BRG40/40G (II-Serie)	1206400
2	101909	Gashahn		1031503700
3	100073	Zündbrenner		1031027800 509900
4	100703	Zündkerze	BRG40/40G (I+II-Serie)	1031025700 636700



Abb.	Bestell-Nr.	Beschreibung	Gerätetyp	Vergleichs-Nr.
1	415077	1300W/230V		1037301700 1037301713
2	359139	Signallampe/grün		1037300800 1037300810
3	359140	Signallampe/gelb	BRE40/40G (I+II-Serie)	1037300900 1037300910
4	110405	Knebel		1036700500
5	110408	Knebel		1036702200

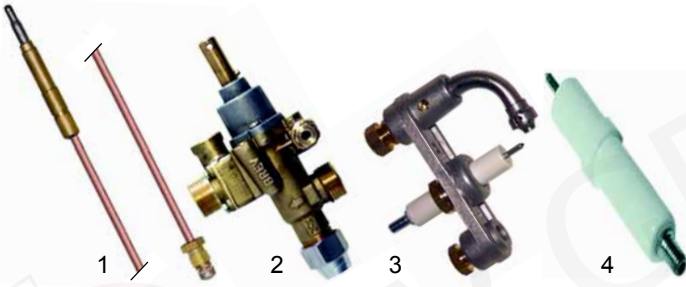

Abb.	Bestell-Nr.	Beschreibung	Gerätetyp	Vergl.-Nr.
1	100186	Zündkabel	BRG40/40G (I-Serie)	1047024400
2	100013	Piezozünder, 22mm		1031500600



Abb.	Bestell-Nr.	Beschreibung	Gerätetyp	Vergleichs-Nr.
1	375412	Thermostat		1037035200
2	550060	Bügel	BRE40/40G (I-Serie)	1037003300
3	300080	Vorsatzschalter		1037033200



Abb.	Bestell-Nr.	Beschreibung	Gerätetyp	Vergl.-Nr.
1	100186	Zündkabel	BRG40/40G (II-Serie)	1936300
2	100009	Piezozünder, 18mm		1936100



Abb.	Bestell-Nr.	Beschreibung	Gerätetyp	Vergleichs-Nr.
1	375192	Thermostat		1309100
2	550060	Bügel	BRE40/40G (II-Serie ab 1997)	921200
3	300080	Vorsatzschalter		710300



Abb.	Bestell-Nr.	Beschreibung	Gerätetyp	Vergleichs-Nr.
1	110406	Knebel		1036700300
2	110450	Knebel	BRG40/40G (I+II-Serie)	1036702300
3	110361	Knebel		1036703300
4	110601	Symbol		1039111800



Abb.	Bestell-Nr.	Beschreibung	Gerätetyp	Vergleichs-Nr.
1	110362	Knebel	BRE40/40G (I-Serie)	1036700900
2	110615	Symbol		1039107500
3	110362	Knebel	BRE40/40G (II-Serie)	1036700900
4	110614	Symbol		1840400

M

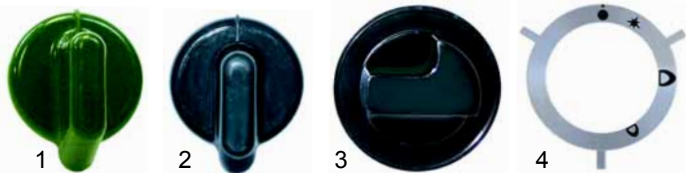
Multibräter (Elektro)



Abb.	Bestell-Nr.	Beschreibung	Gerätetyp	Vergl.-Nr.
1	416698	1300W/230V	VB7-4E,	1037317700
2	375187	Sicherheitsthermostat	VB7-6E,	1878500
3	359140	Signallampe/gelb	VB9-6E	1037300910



Abb.	Bestell-Nr.	Beschreibung	Gerätetyp	Vergleichs-Nr.
1	375192	Thermostat		1309115
2	550060	Bügel	VB7-4E,	921200
3	300080	Vorsatzschalter	VB7-6E,	710300
4	110998	Knebel	VB9-6E	CM059806

Nudelkocher (Gas)

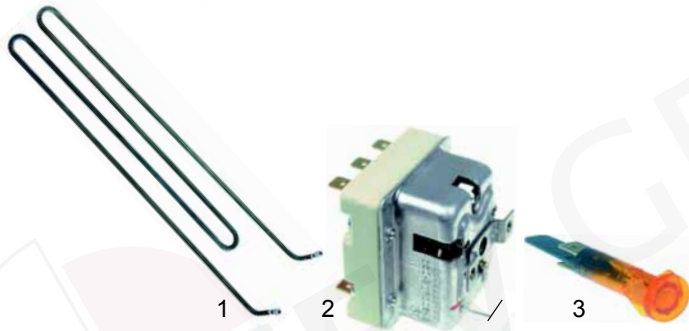

Abb.	Bestell-Nr.	Beschreibung	Gerätetyp	Vergleichs-Nr.
1	105496	Brenner	CPG60	1031502600
2	105497	Brenner	CP70-7G	1729700
3	104243	Brenner	CP70-4G	1833100



Abb.	Bestell-Nr.	Beschreibung	Gerätetyp	Vergleichs-Nr.
1	104244	Brenner	CP9-__, CP9SB-__	2708514 2708500
2	105498	Brenner	PC7-4G	CM088200
3	105499	Brenner	PC7-6G, PC9-6G, PC9S-6G	CM088100



Abb.	Bestell-Nr.	Beschreibung	Gerätetyp	Vergleichs-Nr.
1	102034	Thermoelement		1033027500
2	101457	Gashahn	CPG-60	1031027900
3	100013	Piezozünder		1031500600
4	100186	Zündkabel		1047024400



Abb.	Bestell-Nr.	Beschreibung	Gerätetyp	Vergleichs-Nr.
1	110406	Knebel		1036700300
2	110450	Knebel	CPG-60	1036702300
3	110361	Knebel		1036703300
4	110601	Symbol		1039110800



Abb.	Bestell-Nr.	Beschreibung	Gerätetyp	Vergl.-Nr.
1	100837	Zündbrenneroberteil		1031501900
2	100883	Zündbrennerunterteil		1031501800
3	100706	Zündkerze	CPG-60	1031502500
4	100893	Zündbrennerhalter		1031502200
5	100894	Gegenhalter		1031502300

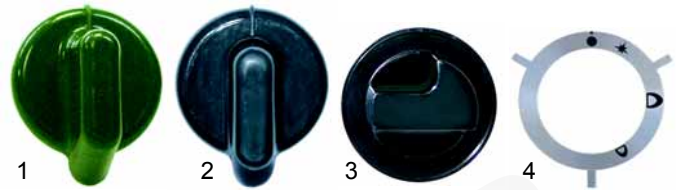

Abb.	Bestell-Nr.	Beschreibung	Gerätetyp	Vergleichs-Nr.
1	102042	Thermoelement		2716500
2	101089	Gashahn	CP70-7G	1337200
3	110364	Knebel		1840900
4	110601	Symbol		1842000



Abb.	Bestell-Nr.	Beschreibung	Gerätetyp	Vergleichs-Nr.
1	102041	Thermoelement		90520
2	101089	Gashahn	CP9-2G/4G	1337200
3	110388	Knebel	(I-Serie)	1322200
4	110620	Symbol		1322300



Abb.	Bestell-Nr.	Beschreibung	Gerätetyp	Vergleichs-Nr.
1	100859	Zündbrenner	CP70-4G,	1887700
2	100701	Zündkerze	CP9-2G/4G,	1888300
3	100186	Zündkabel	CP9SB-2G/	1936300
4	100009	Piezozünder	4G (II-Serie)	1936100



Abb.	Bestell-Nr.	Beschreibung	Gerätetyp	Vergl.-Nr.
1	100073	Zündbrenner		509900
2	100703	Zündkerze	CP70-7G,	636700
3	100199	Zündkabel, 500mm	CP9-2G/4G	1152500
4	100003	Piezozünder		986000



Abb.	Bestell-Nr.	Beschreibung	Gerätetyp	Vergleichs-Nr.
1	102042	Thermoelement	PC7-4G/6G,	CM029100
2	101086	Gashahn	PC9-6G,	1888600
3	110993	Knebel	PC9S-6G	CM061600

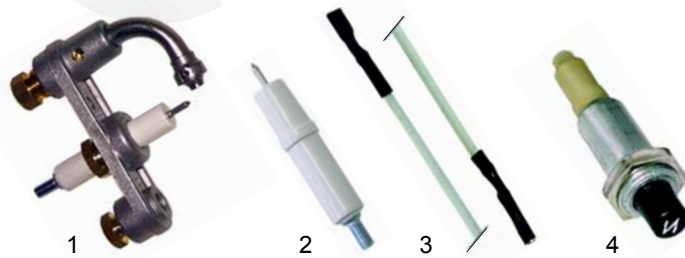

Abb.	Bestell-Nr.	Beschreibung	Gerätetyp	Vergleichs-Nr.
1	102042	Thermoelement		1916000
2	101086	Gashahn	CP70-4G	1888600
3	110364	Knebel		1840900
4	110601	Symbol		1842000



Abb.	Bestell-Nr.	Beschreibung	Gerätetyp	Vergleichs-Nr.
1	100109	Zündbrenner		CM040800
2	100701	Zündkerze	PC7-4G	1888300
3	100186	Zündkabel		1936300
4	100009	Piezozünder		1936100



Abb.	Bestell-Nr.	Beschreibung	Gerätetyp	Vergleichs-Nr.
1	102042	Thermoelement		1916000
2	101086	Gashahn	CP9-2G/4G,	1888600
3	110388	Knebel	CP9SB-2G/	1322200
4	110620	Symbol	4G (II-Serie)	1322300

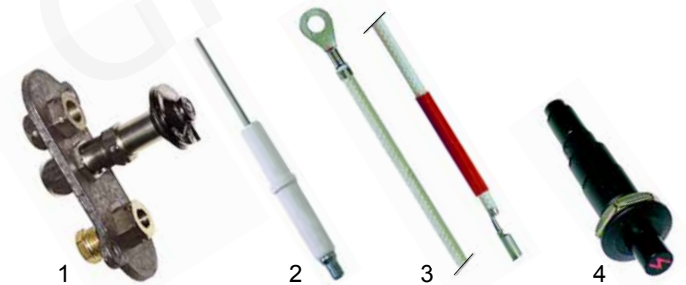

Abb.	Bestell-Nr.	Beschreibung	Gerätetyp	Vergleichs-Nr.
1	100050	Zündbrenner		CM029000
2	100701	Zündkerze	PC7-6G,	1949900
3	100186	Zündkabel	PC9-6G,	1936300
4	100009	Piezozünder	PC9S-6G	1936100

M Nudelkocher (Elektro)

Passend für Mareno



Abb.	Best.-Nr.	Beschreibung	Gerätetyp	Vergl.-Nr.
1	416699	4500W/3x230V	CPE-60 (I-Serie)	1037301200
2	415094	9000W/3x230V	CPE-60 (II-Serie)	1037305800
3	415971	9000W/3x230V	CPE-60 (III-Serie), PC7-6E, PC9-6E	1037305810 1870100 1677000



Abb.	Best.-Nr.	Beschreibung	Gerätetyp	Vergl.-Nr.
1	415977	5670W/3x230V	CP70-4E, PC7-4E	1870000
2	415991	8500W/3x230V	CP9-2E/4E, CP9-2E/2, CP9-4E/2, PC9-4E/8E	1814213 1869900

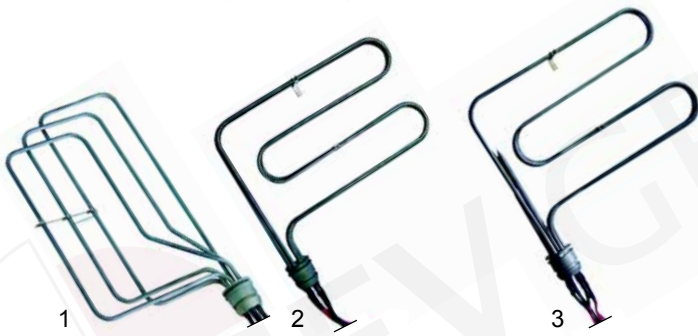

Abb.	Bestell-Nr.	Beschreibung	Gerätetyp	Vergleichs-Nr.
1	514018	Buchse		1033703500 1814600
2	514021	O-Ring	CPE-60, CP70-4E, PC70-4E/6E,	1036500300 1814700
3	514022	Mutter, 1/2"	CP9-2E/4E, CP9-2E/2, CP9-4E/2,	1032300100 14044599
4	514016	Teflondichtung	PC9-4E/2, PC9-4E/6E/8E	1036500400 1814500
5	514017	O-Ring/Heizung		1036500200 1814400

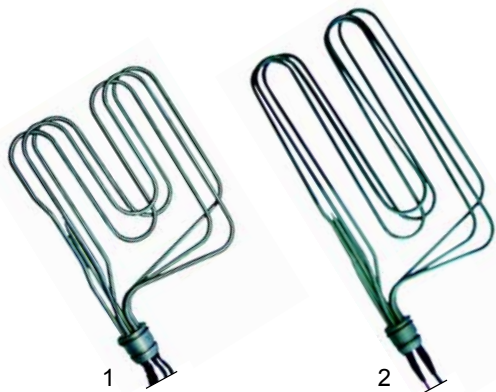

Abb.	Best.-Nr.	Beschreibung	Gerätetyp	Vergl.-Nr.
1	514020	Heizkörperbuchse	CPE-60 (Heizung ohne Tauchhülse)	1815014 1815000 1036500100
2	514019	Gewindestange, M8		1033202200 1033709000
3	540435	Gewindehohl- stange, M10	CPE-60, CP70-4E, PC7-4E/6E, CPE-2E/4E,	1869600
4	540439	Abstandsbuschse	CPE-2E/2, CPE-4E/2,	1869500
5	540436	Mutter, M10	PC9-4E/6E/8E	1033514900
6	540438	Langmutter, M10		1868700



Abb.	Best.-Nr.	Beschreibung	Gerätetyp	Vergl.-Nr.
1	300104	Viertaktschalter		1037100500 790700
2	110463	Knebel	CPE-60 (II-Serie)	1036700700
3	110360	Knebel		1840700
4	110605	Symbol		1039111200



Abb.	Best.-Nr.	Beschreibung	Gerätetyp	Vergl.-Nr.
1	300104	Viertaktschalter		790700
2	110386	Knebel	CP9-2E, CP9-4E	1508100
3	110626	Symbol		1322700



Abb.	B.-Nr.	Beschreibung	Gerätetyp	Ver.-Nr.
1	380015	Energierегler	CPE60E (III-Serie), CP70-4E, CP9-2E/4E,	426710
2	380213	Schütz	CP9S-2E/4E, PC7-4E/8E,	21453199 CM187300
3	375199	Sicherheitsthermostat	PC9-4E/6E/8E, PC9S-4E/6E/8E	1878900



Abb.	Bestell-Nr.	Beschreibung	Gerätetyp	Vergl.-Nr.
1	110463	Knebel		1036700700
2	110360	Knebel	CPE-60E (IV-Serie), CP70-4E	1840700
3	110607	Symbol		1986600



Abb.	Bestell-Nr.	Beschreibung	Gerätetyp	Vergl.-Nr.
1	110386	Knebel	CP9-2E/4E, CP9S-2E/4E	1508100
2	110627	Symbol		1966800
3	110995	Knebel	PC7-__, PC9-__	CM062500

Nudelkocher (Mechanik)



Abb.	Bestell-Nr.	Beschreibung	Gerätetyp	Vergleichs-Nr.
1	514012	Auslaufhahn, 3/4"		1450500 1031103600
2	514013	Hebelgelenk	CPE-60	1031400400
3	514008	Hebelgriff		1036700000
4	514015	Hebelgriff		1036702000



Abb.	Bestell-Nr.	Beschreibung	Gerätetyp	Vergleichs-Nr.
1	514005	Auslaufhahn		1031024110
2	514007	Hebelgelenk		1044109600
3	514008	Hebelgriff	CPG-60	1036700000
4	514015	Hebelgriff		1036702000
5	514006	Auslaufrohr		1033061900



Abb.	Bestell-Nr.	Beschreibung	Gerätetyp	Vergl.-Nr.
1	514012	Auslaufhahn, 3/4"		1450500
2	514050	Verlängerung	CP9-2G/4G, CP9-2G/4E,	1515500
3	514051	Griff	CP9SB-2E/4E,	32000599
4	514052	Einlaufhahn	CP9SB-2G/4G	1475300
5	514053	Griff		832400



Abb.	Best.-Nr.	Beschreibung	Gerätetyp	Vergl.-Nr.
1	514012	Auslaufhahn, 3/4"		1450500
2	514054	Verlängerung	CP70-4G, CP70-4E	1959600
3	514055	Einlaufhahn		700714
4	514051	Griff		32000599



Abb.	Bestell-Nr.	Beschreibung	Gerätetyp	Vergleichs-Nr.
1	514056	Auslaufhahn	PC7-, PC9-	1950700
2	514057	Verlängerung	PC7-6E/G	CM197300
3	514058	Verlängerung	PC9-6E/G	CM202900
4	514059	Hebel	PC7-, PC9-	CM155200



Abb.	Bestell-Nr.	Beschreibung	Gerätetyp	Vergleichs-Nr.
1	514060	Einlaufhahn	PC7-6G/6E, PC9-6G/6E	CM127800
2	514061	Knebel		CM143100



Abb.	Best.-Nr.	Beschreibung	Gerätetyp	Vergl.-Nr.
1	970196	Korb	CPG-60, LPE-60	1031100000
2	970197	Korb, 1/3	CP9-_, CP70-_,	1510100
3	970347	Korb, 1/3	PC7-_, PC9-_	MA9733700



Abb.	Best.-Nr.	Beschreibung	Gerätetyp	Vergl.-Nr.
1	970348	Korb, 2/3	CP9-_, CP70-_,	MA9733800
2	970351	Korb, 1/2	PC7-_, PC9-_	MA9733900

Bainmarie (Gas)



Abb.	Bestell-Nr.	Beschreibung	Gerätetyp	Vergleichs-Nr.
1	104150	Brenner	BMG-40/60	1031002300
2	105513	Brenner	BM7-4G/7G	1845614
3	105514	Brenner	B9V-2G/4G, B9SB-2G/4G	1360700 1360724

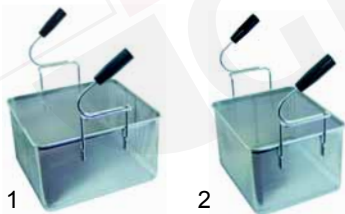

Abb.	Bestell-Nr.	Beschreibung	Gerätetyp	Vergleichs-Nr.
1	105515	Brenner	B7-4G, B9-4G	CM140600
2	105516	Brenner	B7-8G, B9-8G	CM140700



Abb.	Bestell-Nr.	Beschreibung	Gerätetyp	Vergleichs-Nr.
1	101088	Minisitregler		1031501100
2	111501	Knebel	BMG-40/60	1036700400
3	110407	Knebel		1036702400
4	110068	Knebel		1393500



Abb.	B.-Nr.	Beschreibung	Gerätetyp	Ver.-Nr.
1	101104	Babysitregler	702-BMG, BC-2GS/4GS, BH-2GS/4GS, BM7-4G/7G, B9V-2G/4G, B9SB-2G/4G (II+III-Serie)	711500 1047100 1047112 1876200 1876300
2	101130	Minisitregler		1120813 1393400
3	101137	Abdeckkappe	BM7-4G/7G (I-Serie)	1393600
4	110068	Knebel		1393500



Abb.	Best.-Nr.	Beschreibung	Gerätetyp	Ver.-Nr.
1	101441	Gasthermostat PEL25	B7-4G/8G, B9-4G/8G	CM140500
2	111502	Knebel		CM140200
3	102041	Thermoelement, 600mm	BMG-40, 702BMG, BC-2GS/4GS, BH-2GS/4GS, BM7-4G/7G, B9V-2G, B9SB-2G	1033027600 1031501500 90520
3	102042	Thermoelement, 850mm	BMG-60, BM7-4G/7G (II-Serie), B9V-2G, B9SB-2G (II-Serie), B7-4G/8G, B9-4G/8G	1031501600 1916000 CM029100
3	102044	Thermoelement, 1200mm	B9V-4G, B9SB-4G	263800

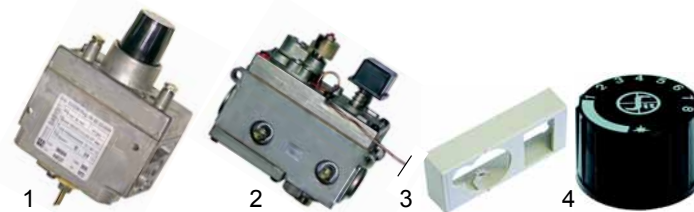

Abb.	Bestell-Nr.	Beschreibung	Gerätetyp	Vergleichs-Nr.
1	100073	Zündbrenner	BMG-40/60 (I+II-Serie)	1031027800
2	100703	Zündkerze		1031025700
3	100019	Zündkabel, 900mm		1047024400 1047024600
4	100013	Piezozünder		1031500600



Abb.	Bestell-Nr.	Beschreibung	Gerätetyp	Vergleichs-Nr.
1	100073	Zündbrenner	BM7-4G/7G (I-Serie)	411111
2	100703	Zündkerze		638700
3	100199	Zündkabel, 600mm		1152700
4	100003	Piezozünder		986000



Abb.	Bestell-Nr.	Beschreibung	Gerätetyp	Vergleichs-Nr.
1	100073	Zündbrenner	BMG-40/60 (III-Serie)	509900
2	100703	Zündkerze		636700
3	100186	Zündkabel		1936300
4	100009	Piezozünder		1936100



Abb.	Bestell-Nr.	Beschreibung	Gerätetyp	Vergl.-Nr.
1	100046	Zündbrenner	B9V-2G/4G, B9SB-2G/4G (I-Serie)	431500
2	100706	Zündkerze		224211
3	100199	Zündkabel, 600mm		1088600
3	102155	Zündkabel, 750mm		1152600
4	100003	Piezozünder	986000	

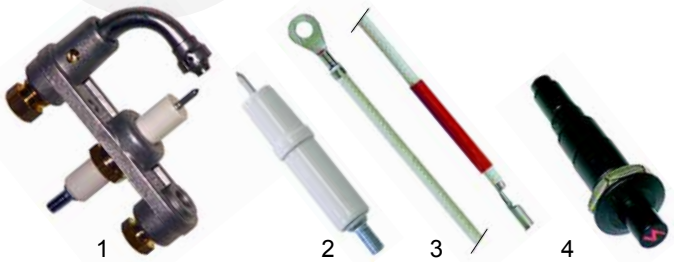

Abb.	Best.-Nr.	Beschreibung	Gerätetyp	Ver.-Nr.
1	100046	Zündbrenner	BC-2GS/4GS, BA-2GS/4GS (I-Serie)	431500
2	100706	Zündkerze		224211
3	100025	Zündkabel, 600mm		671300
				671400
				671500 672400
4	100007	Piezozünder	224311	



Abb.	Best.-Nr.	Beschreibung	Gerätetyp	Ver.-Nr.
1	100859	Zündbrenner	BM7-4G/7G (III-Serie), B9V-2G/4G, B9SB-2G/4G (II-Serie)	1887700
2	100701	Zündkerze		1888300
3	100186	Zündkabel		1936300
4	100009	Piezozünder		1936100



Abb.	Best.-Nr.	Beschreibung	Gerätetyp	Ver.-Nr.
1	100046	Zündbrenner	BE-2G/4G, BA-2G/4G (II-Serie), BM7-4G/7G (II-Serie)	1314500
2	100706	Zündkerze		224211
3	100199	Zündkabel, 600mm		1088600
4	100003	Piezozünder		986000



Abb.	Best.-Nr.	Beschreibung	Gerätetyp	Ver.-Nr.
1	100050	Zündbrenner	B7-4G/8G, B9-4G/8G	CM029000
2	100701	Zündkerze		1949900
3	100186	Zündkabel		1936300
4	100009	Piezozünder		1936100

M

Bainmarie (Elektro)

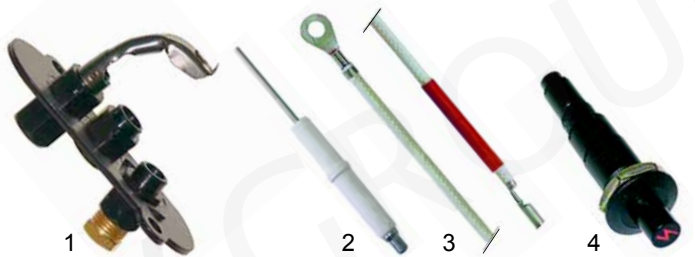

Abb.	Best.-Nr.	Beschreibung	Gerätetyp	Ver.-Nr.
1	415082	2200W/240V	702 BME BC-2E/ BA2E	704100 33610
2	415081	1800W/240V	BC-4E/ BA43	627510
3	415164	900W/240V	702 BME Wärmeschrank	59741
4	415091	1000W/240V	BME 40M/ 60M/ 80M BME70-4E	1037039500 1037039513
5	415092	1300W/240V	BME60 BME60/2 BME70-6E	1037039613



Abb.	Bestell-Nr.	Beschreibung	Gerätetyp	Vergleichs-Nr.
1	415992	1800W/240V	BM7-7E B9V-4E B9SB-4E B7-4E/8E B9-4E/8E	1368400 1634200
2	415083	2200W/240V	BM7-4E B9V-2E B9SB-2E	1360900 1368400 1369700 1634300
3	415979	1500W/240V	BM7-7E	1634100

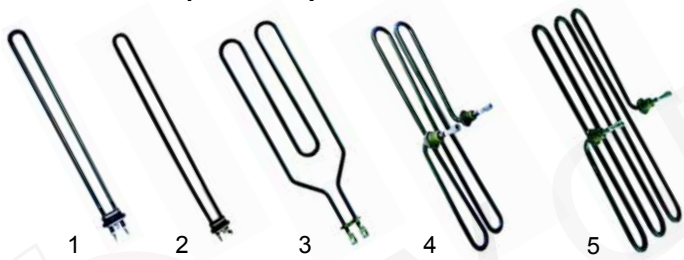

Abb.	B.-Nr.	Beschreibung	Gerätetyp	Vergl.-Nr.
1	375410	Thermostat	BME-40/60, BSE-40M, BME-4E/7E, B7-4E/8E, B9-4E/8E	1037035015 1037035000 1230200
2	550060	Bügel	BME-40/60, BSE-40M, BME-4E/7E (I+III Serie)	1037033300 921200
3	300080	Vorsatzschalter		710300 1037033200
4	300021	Schalter, 0-I	BME-4E/7E (II-Serie), B7-4E/8E, B9-4E/8E	1230100

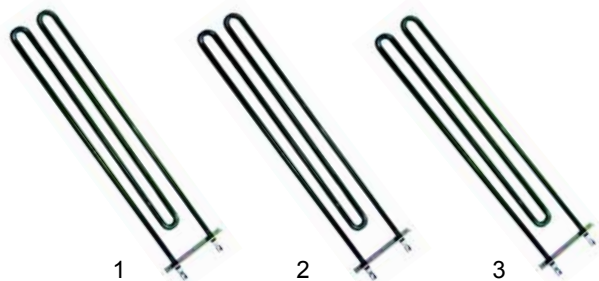

Abb.	Bestell-Nr.	Beschreibung	Gerätetyp	Vergleichs-Nr.
1	n.m.l.	Thermostat		264000
2	375188	Thermostat	BME-702/704, B9V-2E/4E, B9SB2E/4E	Alternativ 264000
3	550148	Stopfbuchse		
4	300080	Vorsatzschalter		710300



Abb.	Bestell-Nr.	Beschreibung	Gerätetyp	Vergleichs-Nr.
1	110405	Knebel		1036700500
2	110408	Knebel	BME-40/60, BSE-40	1036702200
3	110362	Knebel		1036700900
4	110610	Symbol		1218500



Abb.	Bestell-Nr.	Beschreibung	Gerätetyp	Vergleichs-Nr.
1	110360	Knebel		1840700
2	110610	Symbol	BM7-4E, BM7-7E	1218500
3	110604	Symbol		1229000

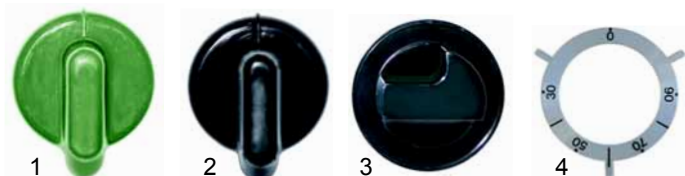

Abb.	Bestell-Nr.	Beschreibung	Gerätetyp	Vergleichs-Nr.
1	110360	Knebel		1840700
2	111531	Symbol	BME-702/704	862500
3	110386	Knebel	B9V-2E/4E, B9SB-2E/4E	1508100
4	110628	Symbol		1323200

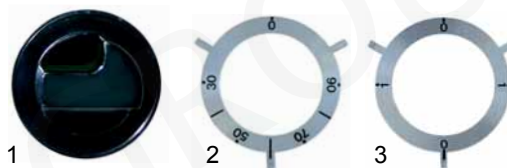

Abb.	Bestell-Nr.	Beschreibung	Gerätetyp	Vergleichs-Nr.
1	111503	Knebel	B7-4E/8E,	CM140000
2	111504	Knebel	B9-4E/8E	CM140100

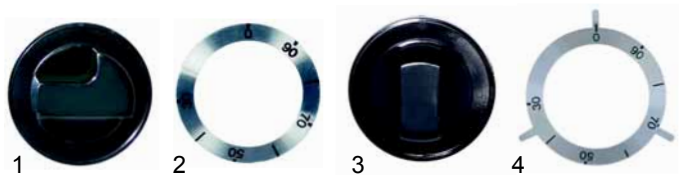

Abb.	Best.-Nr.	Beschreibung	Gerätetyp	Ver.-Nr.
1	359160	Signallampe/grün	BME-702/704,	1230300
2	359159	Signallampe/gelb	B9V-2E/4E (I-Serie), B9SB-2E/4E (I-Serie)	912800
3	359139	Signallampe/grün	BME-40/60, BM7-4E/7E (II-Serie),	1037300800 1037300810
4	359140	Signallampe/gelb	B9V-2E/4E (II-Serie), B9SB-2E/4E (II-Serie), B7-4E/8E, B9-4E/8E	1037300900 1037300910

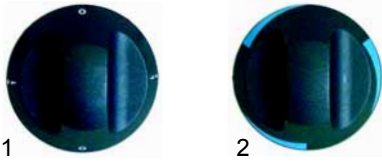

Abb.	Bestell-Nr.	Beschreibung	Gerätetyp	Ver.-Nr.
1	359142	Signallampe/grün	BM7-4E/7E (I-Serie)	1819800
2	359143	Signallampe/gelb		1819900
3	359142	Signallampe/grün	BM70-4E/6E	21016199
4	359143	Signallampe/gelb		21016299



Abb.	Bestell-Nr.	Beschreibung	Gerätetyp	Vergleichs-Nr.
1	514031	Auslaufhahn		1040424
2	514007	Hebelgelenk	BM7-4G/7G, BM7-4E/7E	1044109600
3	514015	Hebelgriff		1851700 103670200
4	514006	Auslaufrohr		1033300300



Abb.	Bestell-Nr.	Beschreibung	Gerätetyp	Vergl.-Nr.
1	514221	Überlaufrohr	B7-4G/8G/4E/8E,	CM142100
2	Dichtung	B9-4G/8G/4E/8E	CM142000	

Frittenwärmer

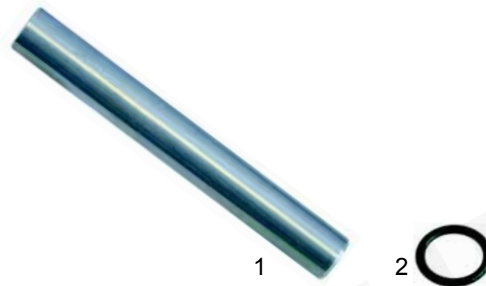

Abb.	Best.-Nr.	Beschreibung	Gerätetyp	Vergl.-Nr.
1	415091	1000W/240V	BSE-40M	1037039500 1037039513
2	415104	1000W/240V	CSP-6220 CSP-6220	1037039600

Bainmarie (Mechanik)



Abb.	Bestell-Nr.	Beschreibung	Gerätetyp	Vergleichs-Nr.
1	514005	Auslaufhahn		1031024100
2	514007	Hebelgelenk		1044109600
3	514008	Hebelgriff	BMG- BME	1036700000
4	514015	Hebelgriff		1036702000
5	514006	Auslaufrohr		1033061900



Abb.	Bestell-Nr.	Beschreibung	Gerätetyp	Vergleichs-Nr.
1	514031	Auslaufhahn		10404-10 40404-24
2	514032	Hebelgelenk	B9V-2G/4G, B9V-2E/4E,	10416-22
3	514033	Hebelgriff	B9SB-2G/4G,	498500
4	514006	Auslaufrohr	B9CB-2E/4E	866100 1033300300

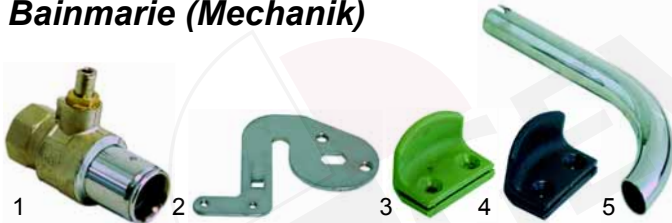

Abb.	Bestell-Nr.	Beschreibung	Gerätetyp	Vergleichs-Nr.
1	375410	Thermostat	BSE-40M	1037035015
2	300080	Vorsatzschalter	CSP	710300
3	301003	Schalter	CSP	4640500

Friteusen (Gas)

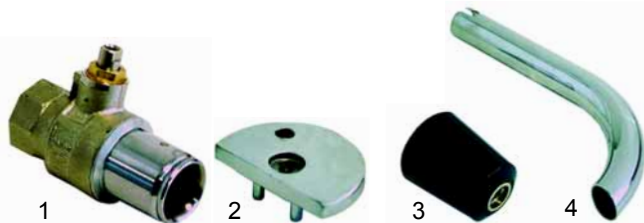

Abb.	Best.-Nr.	Beschreibung	Gerätetyp	Vergl.-Nr.
1	104242	Brenner/rechts	FQG-40/60	1032001300
2	104241	Brenner/links		1032001200
3	105517	Brenner	FR7-4G/7G, FR9-2G13/22, FR9-4G13/22	1450000
4	105518	Brenner	F7-4G15/8G15, F9-4G15/8G15, F9S-4G15/8G15, F9S-4G22/8G22	CM011401

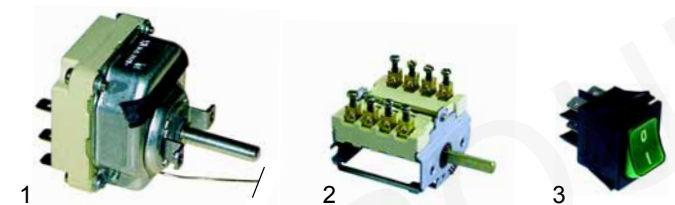

Abb.	Bestell-Nr.	Beschrbg.	Gerätetyp	Ver.-Nr.
1	101431	Minisitregler	FQG-40/60 (I-Serie), FR7-4G/7G	1031500300 1743300 1743324
1	101437	Minisitregler	FQG-40/60 (II-Serie), FR9-2G13/4G13	1393300 1451000 1451024
2	101127	Elettrosit	FR9-2G22/4G22 (I-Serie)	1450100



Abb.	B.-Nr.	Beschreibg.	Gerätetyp	Ver.-Nr.
1	101187	Novasit (mV)	FR9-2G22/4G22 (II-Serie), F9-4G22/8G22, F9S-4G22/8G22	1870800
2	101908	Novasit (230V)	FR-2G22T/4G22T	1871200
3	101188	Eurositregler	F7-4G15/8G15, F9-4G15/8G15, F9S-4G15/8G15	CM097000

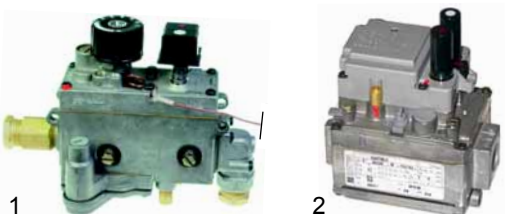

Abb.	Bestell-Nr.	Beschreibung	Gerätetyp	Vergleichs-Nr.
1	101137	Abdeckkappe	FR7-4G/7G, FR9-2G13, FR9-4G13	1393600
2	101136	Abdeckkappe mit Piezozünder		1393700
3	110068	Knebel	FQG-40/60	1393500
4	111501	Knebel		1036700400
5	110407	Knebel		1036702400



Abb.	Best.-Nr.	Beschreibung	Gerätetyp	Ver.-Nr.
1	101265	Unterbrecheranschluss M9x1		1533400 1031500500
2	102039	Thermoelement, 320mm		1031500400
3	102247	Thermoelement, 600mm, mit Unterbrechung	FR7-4G/7G (I-Serie), FR9-2G13/22 (I-Serie), FR9-4G13/22 (I-Serie), FR7-4G/7G (II-Serie), FR9-2G13/22/22T (II-Serie), FR9-4G13/22/22T (II-Serie), F7-4G15/8G15, F9-4G15/22/22K, F9-8G15/22/22K, F9S-4G15/22, F9S-8G15/22	838323 1950100



Abb.	Bestell-Nr.	Beschreibung	Gerätetyp	Vergl.-Nr.
1	100073	Zündbrenner	FQG40/60 (I-Serie)	1031027800
2	100703	Zündkerze		1031025700
3	100019	Zündkabel		1047024600
4	100013	Piezozünder		1031500600

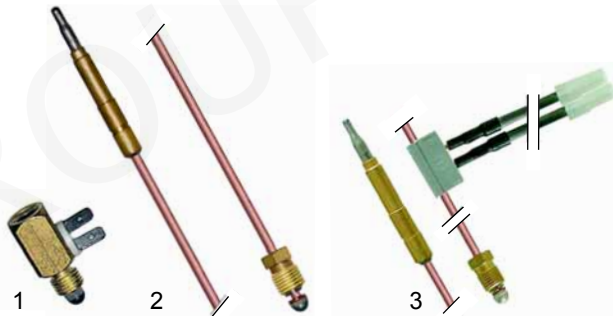

Abb.	Bestell-Nr.	Beschreibung	Gerätetyp	Ver.-Nr.
1	100073	Zündbrenner	FQG40/60 (II-Serie)	509900
2	100703	Zündkerze		636700
3	100186	Zündkabel		1936300
4	100009	Piezozünder		1936100



Abb.	Bestell-Nr.	Beschreibung	Gerätetyp	Vergl.-Nr.
1	100073	Zündbrenner	FR7-4G/7G (I-Serie)	411111
2	100703	Zündkerze		636700
3	100199	Zündkabel		1152700
4	100003	Piezozünder		986000

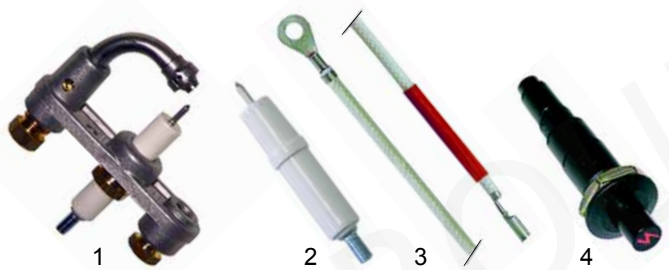

Abb.	B.-Nr.	Beschreibg.	Gerätetyp	Vergl.-Nr.
1	375323	Sicherheits-thermostat	FQG-40/60 (I-Serie)	1031028000
2	375358	Sicherheits-thermostat	FQG-40/60 (II-Serie), FR7-4G/7G (II-Serie), FR9-2G13/22/22T (II-Serie), FR9-40G13/22/22T (II-Serie)	1871100
3	390061	Sicherheits-thermostat	FR7-4G/7G (I-Serie), FR9-2G13/22 (I-Serie), FR9-4G13/22 (I-Serie)	732913

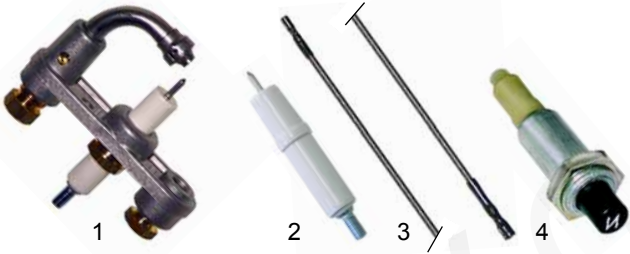

Abb.	Bestell-Nr.	Beschreibung	Gerätetyp	Vergl.-Nr.
1	100073	Zündbrenner	FR9-2G13 (I-Serie), FR9-4G13 (I-Serie)	411111
2	100703	Zündkerze		636700
3	100025	Zündkabel		1394600
4	100001	Piezozünder		-

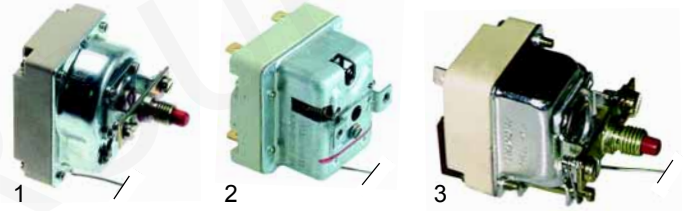

Abb.	Bestell-Nr.	Beschreibung	Gerätetyp	Vergl.-Nr.
1	375359	Sicherheits-thermostat	F7-4G15/8G15, F9-4G15/22/22K, F9-8G15/22/22K, F9S-4G15/22, F9S-8G15/22	CM097700
2	102116	MV Generator	F9-2G22/4G22, F9-4G22/8G22, F9S-4G22/8G22	1870712



Abb.	Bestell-Nr.	Beschreibung	Gerätetyp	Vergl.-Nr.
1	100073	Zündbrenner	FR9-2G22 (I-Serie), FR9-4G22 (I-Serie)	411111
2	100703	Zündkerze		636700
3	100199	Zündkabel		1152800
4	101002	Zündgruppe		1450300

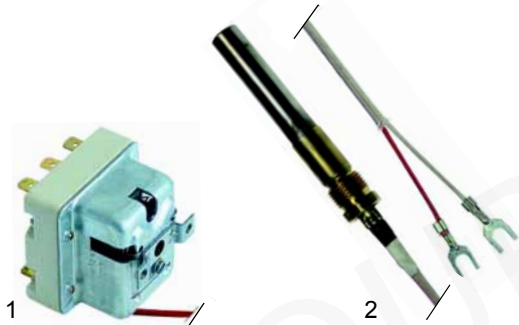

Abb.	Bestell-Nr.	Beschreibung	Gerätetyp	Ver.-Nr.
1	390046	Thermostat	FR9-2G22 (I-Serie), FR9-4G22 (I-Serie)	1450914 1450900
2	300080	Vorsatzschalter		710300
3	110386	Knebel	FR9-2G22 (I-Serie), FR9-4G22 (I-Serie)	1508100
4	110629	Symbol		1322900
5	359160	Signallampe/grün		1230300
6	359159	Signallampe/gelb		912800

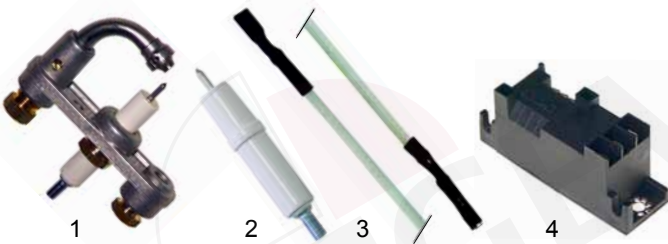

Abb.	B.-Nr.	Beschreibung	Gerätetyp	V.-Nr.
1	100837	Zündbrenner/ Oberteil	FR7-4G/7G (II-Serie), FR9-2G13/22/22T (II-Serie),	1576000
2	100883	Zündbrenner/ Unterteil	FR9-4G13/22/22T (II-Serie), F7-4G15/8G15, F9-4G15/22/22K,	1874100
3	100706	Zündkerze	F9-8G15/22/22K,	224211
4	100186	Zündkabel	F9S4G15/22, F9S8G15/22	1936300
5	100009	Piezozünder		1936100

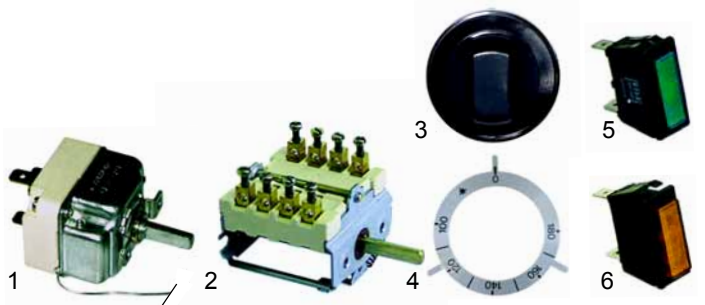

Abb.	Bestell-Nr.	Beschreibung	Gerätetyp	Ver.-Nr.
1	390046	Thermostat		1450914
2	110386	Knebel	FR9-2G22 (II-Serie), FR9-4G22 (II-Serie)	1508100
3	110629	Symbol		1322900



Abb.	Bestell-Nr.	Beschreibung	Gerätetyp	Vergleichs-Nr.
1	345525	Schaltelement		2860900
2	345482	Elemententräger	F9-4G22K, F9-8G22K	2860700
3	345526	Wahlschalter		2860600
4	601038	Lüfter		CM250700

Friteusen (Elektro)



Abb.	B.-Nr.	Beschreibung	Gerätetyp	Ver.-Nr.
1	415090	5550W/3x230V	FQE-40, FQE-60, FRE-702/703	1037039900 1037039915 892900
1	415963	7250W/3x230V	FQE-40SP, FQE-60SP	1037301600 1037301615
2	415962	2000W/230V	FQE41L (bis 4.'98), FQE61L (bis 4.'98), FR7-4E10L (bis 4.'98), FR7-7E10L (bis 4.'98), FR9-2E10L, FR9-4E10L	1037314944
2	415961	3000W/230V	FQE41 (bis 4.'98), FQE61 (bis 4.'98), FR7-4E10 (bis 4.'98), FR7-7E10 (bis 4.'98), FR9-2E10	1037313044
3	416810	6000W/3x230V	FQE41L (ab 5.'98), FQE61L (ab 5.'98), FR74E10L (ab 5.'98), FR77E10L (ab 5.'98), FR9-2E10L, FR9-4E10L	1037317100
3	416811	9000W/3x230V	FQE41 (ab 5.'98), FQE61 (ab 5.'98), FR74E10 (ab 5.'98), FR74E10 (ab 5.'98), FR9-2E10	1037317200

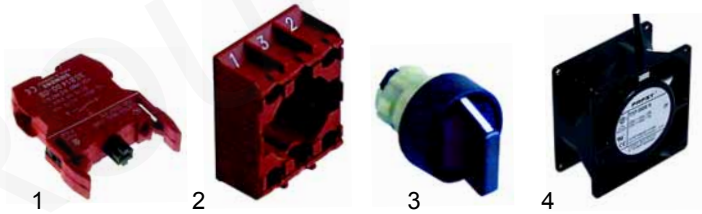

Abb.	Best.-Nr.	Beschreibung	Gerätetyp	V.-Nr.
1	415976	2300W/230V	FR7-4E/7E (I-Serie)	1750000
2	415969	2400W/230V	FR7-4E/7E (II-Serie)	1982700
3	415989	3000W/230V	FR9-2E13/E13T (II-Serie), FR9-4E13/13T (II-Serie)	1982800



Abb.	Bestell-Nr.	Beschreibung	Gerätetyp	Vergl.-Nr.
1	101816	Adapter	F7-4G15/8G15, F9-4G15/8G15, F9S-4G15/8G15	CM057701
2	110415	Knebel		CM062301
3	375331	Thermostat mit Vorsatzschalter	F9-4G22/8G22, F9S-4G22/8G22	CM097800
4	110410	Knebel		CM062200



Abb.	Bestell-Nr.	Beschreibung	Gerätetyp	Vergleichs-Nr.
1	n.m.l.	Elektronikregler	FR9-2G22T, FR9-4G22T	1479300 1479315
2	379387	Fühler		1957600

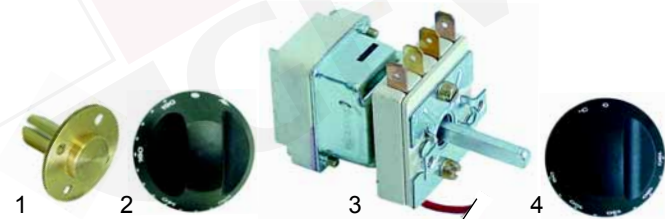

Abb.	Bestell-Nr.	Beschreibung	Gerätetyp	Vergl.-Nr.
1	345525	Schaltelement, 1 NO		2860900
2	345482	Elemententräger	FR9-2G22T, FR9-4G22T	2860700
3	345526	Wahlschalter		2860600

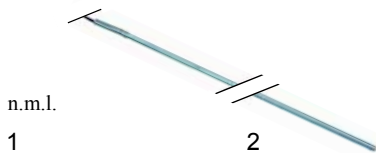

Abb.	Bestell-Nr.	Beschreibung	Gerätetyp	Ver.-Nr.
1	400688	Frontfolie		CM247301
2	400687	Elektronikregler, kpl.	F9-4G22K, F9-8G22K	CM295800
3	379388	Fühler (J)		CM295900



Abb.	Best.-Nr.	Beschreibung	Gerätetyp	Ver.-Nr.
1	415990	5800W/230V	FR9-2E22/22T (II-Serie), FR9-4E22/22T (II-Serie)	1982900
2	415089	1850W/230V	FR-2E15, FR-4E15, FR-15E/E2	132522
3	415985	3000W/230V	FR9-2E13 (I-Serie), FR9-4E13 (I-Serie)	1463900 1466100
4	415986	5000W/230V	FR9-2E22 (I-Serie), FR9-4E22 (I-Serie)	1464000 1466200

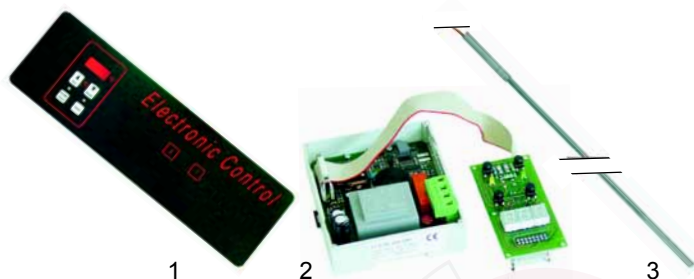

Abb.	Bestell-Nr.	Beschreibung	Gerätetyp	Vergl.-Nr.
1	416812	9000W/3x230V	F7-__E10, F9-__E10	1037316600 1037316601
2	416813	9000W/3x230V	F7-__E12, F9-__E12, F9S-__E12	CM032101
3	416814	9000W/3x230V	F9-__E18/18K, F9S-__E18/18K	CM032401

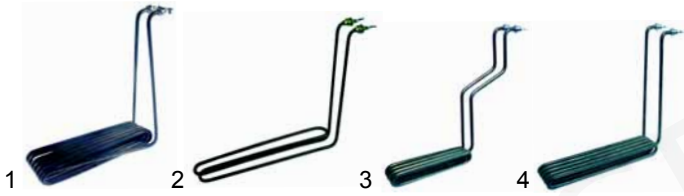

Abb.	Bestell-Nr.	Beschreibung	Gerätetyp	Vergleichs-Nr.
1	550496	O-Ring		CM099200
2	550497	Mutter		CM021600



Abb.	Bestell-Nr.	Beschreibung	Gerätetyp	Vergl.-Nr.
1	375410	Thermostat	FQE40 (I-Serie), FQE60 (I-Serie), FQE40SP (I-Serie), FQE60SP (I-Serie)	1037101400 1037033300 1037033200
2	550060	Bügel		
3	300080	Vorsatzschalter		



Abb.	Best.-Nr.	Beschreibg.	Gerätetyp	Ver.-Nr.
1	375198	Thermostat	FQE40/40SP (II-Serie), FQE60/60SP (II-Serie), FQE41/41L, FQE61/61L, FR7-4E/7E (II-Serie), FR9-2E13/22 (II-Serie), FR9-4E13/22 (II-Serie)	1981900 1873500 921200 1037313200
2	550060	Bügel		
3	300001	Vorsatzschalter		



Abb.	Best.-Nr.	Beschreibung	Gerätetyp	Ver.-Nr.
1	390046	Thermostat	FR7-4E/7E (I-Serie), FR9-2E13/22 (I-Serie), FR9-4E13/22 (I-Serie)	1450900 1450914 921200
2	550060	Bügel		
3	300080	Vorsatzschalter		710300



Abb.	Best.-Nr.	Beschreibung	Gerätetyp	Vergl.-Nr.
1	n.m.l.	Thermostat		426011 893011
2	375410	Thermostat	FRE-702, FRE-703, FR-2E15, FR-4E15, FR-15E	-
3	550060	Bügel		921200
4	300080	Vorsatzschalter		



Abb.	Bestell-Nr.	Beschreibung	Gerätetyp	Vergleichs-Nr.
1	110405	Knebel		1036700500
2	110408	Knebel		1036702200
3	110362	Knebel	FQE (I-Serie) (600 Serien)	1036700900
4	110611	Symbol		1039107200

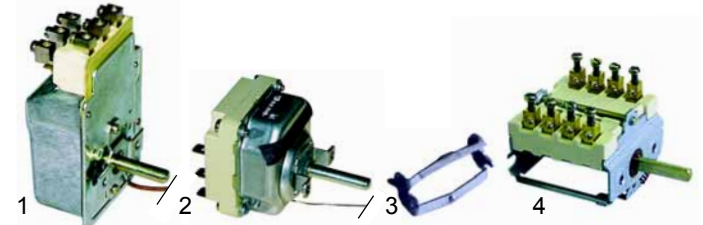

Abb.	Bestell-Nr.	Beschreibung	Gerätetyp	Vergleichs-Nr.
1	110463	Knebel		1036700700
2	110360	Knebel	FQE (II-Serie) (600-Serien)	1840700
3	110611	Symbol		1039107200

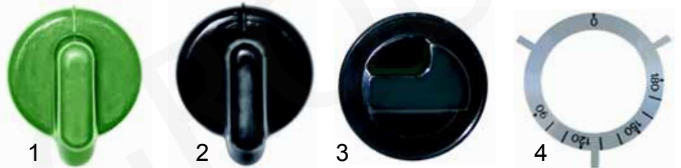

Abb.	Bestell-Nr.	Beschreibung	Gerätetyp	Vergl.-Nr.
1	110360	Knebel		1840700
2	110612	Symbol	FR7- (700-Serien)	1840600
3	110386	Knebel		1508100
4	110629	Symbol	FR9 (900-Serien)	1322900



Abb.	Bestell-Nr.	Beschreibung	Gerätetyp	Vergl.-Nr.
1	375331	Thermostat/Schalter-Kombination	F7-___, F9-___	CM097800
2	110410	Knebel		CM062200

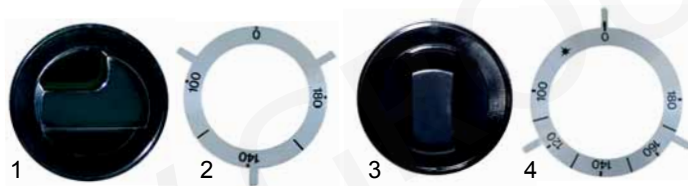

Abb.	B.-Nr.	Beschreibung	Gerätetyp	Ver.-Nr.
1	375104	Sicherheitsthermostat	FQE (I-Serie)	1037035900
2	375189	Sicherheitsthermostat	FQE (II-Serie), FR7-4E/7E (II-Serie), FR9-4E/7E (II-Serie)	1878600 1982000
3	390066	Sicherheitsthermostat	FRE-702/703	893100

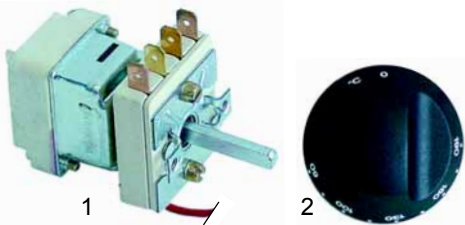

Abb.	Bestell-Nr.	Beschreibung	Gerätetyp	Vergleichs-Nr.
1	n.m.l.	Elektronikregler		1479315
2	379389	Fühler	FR9-2E13T, FR9-4E13T,	1567015
3	345525	Schaltelement	FR9-2E22T, FR9-4E22T	2860900
4	345482	Elemententräger		2860700
5	345526	Wahlschalter		2860600

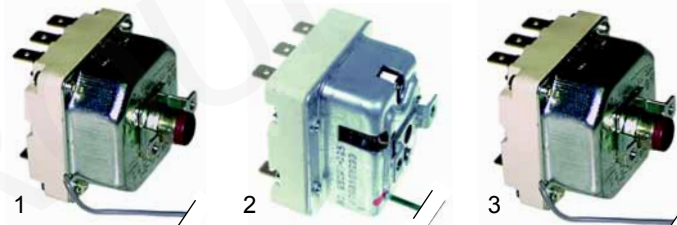

Abb.	Best.-Nr.	Beschreibung	Gerätetyp	Ver.-Nr.
1	390168	Sicherheitsthermostat	FR2E15/4E15, FR15E	733100
2	390061	Sicherheitsthermostat	FR7-4E/7E (I-Serie), FR9-4E/7E (I-Serie)	732913
3	375359	Sicherheitsthermostat	F7- (Protagonista), F9- (Protagonista), F9S- (Protagonista)	CM097700

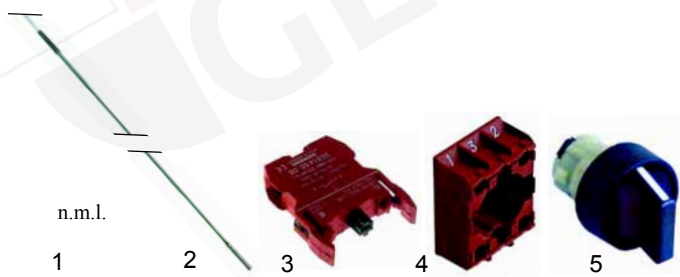

Abb.	Bestell-Nr.	Beschreibung	Gerätetyp	Vergl.-Nr.
1	400688	Frontblende		CM247301
2	400687	Elektronik kpl.	F9-4E18K, F9-8E18K	CM295800
3	379388	Fühler		CM295900

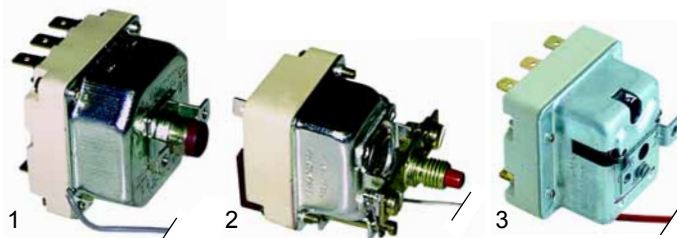

Abb.	B.-Nr.	Beschreibung	Gerätetyp	Vergl.-Nr.
1	345060	Mikroschalter	FQE, FR7-4E10/7E10, FR9-2E10/4E10	1037312900
2	345032	Mikroschalter	FR7-4E/7E, FR9-2E/4E	1267300
3	345254	Mikroschalter	F7-, F9-	1037111300

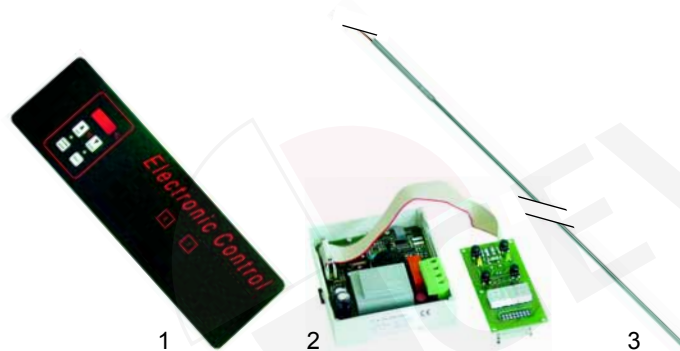

Abb.	Bestell-Nr.	Beschreibung	Gerätetyp	Vergleichs-Nr.
1	345525	Schaltelement		2860900
2	345482	Elemententräger	F9-4E18K, F9-8E18K	2860700
3	345526	Wahlschalter		2860600



Abb.	Best.-Nr.	Beschreibung	Gerätetyp	Vergl.-Nr.
1	359160	Signallampe/grün	FRE-702/703, FR2E15/4E15, FR15, FR9 (I-Serie)	1230300 912800
2	359159	Signallampe/gelb		
3	359139	Signallampe/grün	FQE-___, FR7-4E/7E (II-Serie), FR9- (II-Serie),	1037300800 1037300810
4	359140	Signallampe/gelb	F7- (Protagonista), F9- (Protagonista)	1037300900 1037300910

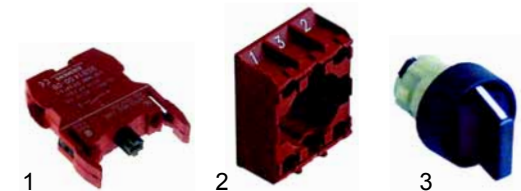

Abb.	Bestell-Nr.	Beschreibung	Gerätetyp	Vergl.-Nr.
1	359142	Signallampe/grün	FR7-4E/7E (I-Serie)	21016199
2	359143	Signallampe/gelb		21016299
3	380213	Schütz	FQE, FR7, F7-, F9-E12	21453199 21450299 CM187300
4	380261	Schütz	FR9, F9-E18	21407999 21453599 CM187400



Abb.	Bestell-Nr.	Beschreibung	Gerätetyp	Ver.-Nr.
1	514056	Auslaufhahn	FR7-__ (Protagonist)	1950700
2	514220	Auslaufrohr	FR9-__ (Protagonist)	CM012000

Friteusen (Mechanik)

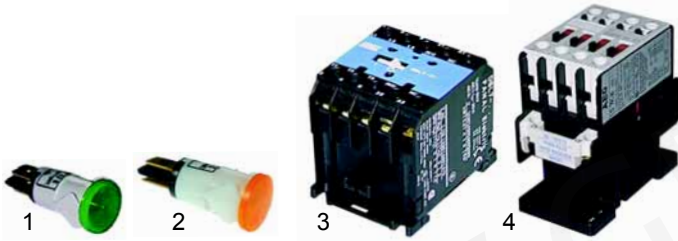

Abb.	Bestell-Nr.	Beschreibung	Gerätetyp	Vergleichs-Nr.
1	514005	Auslaufhahn		1031024110 1031024100
2	514007	Hebelgelenk/links		1044109600
3	514008	Hebelgriff	FQG-, FQE	1036700000
4	514015	Hebelgriff		1036702000
5	514006	Auslaufrohr		1033061900 1033300300



Abb.	Bestell-Nr.	Beschreibung	Gerätetyp	Vergl.-Nr.
1	970156	Korb	FQG-__ (I-Serie), FQE-__ (I-Serie)	1031004810
2	970198	Korb	FQG- (II-Serie), FQE- (II-Serie), FR7-__10, FR9-__10, F7-__10, F9-__10	1031110222 1031110200



Abb.	Bestell-Nr.	Beschreibung	Gerätetyp	Vergleichs-Nr.
1	970170	Korb	FR7, FR9-__13	14647-12 93234-00
2	970171	Korb	FR9-__22	1464600 9323300

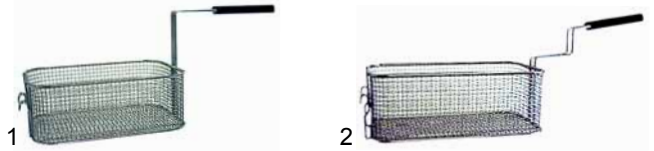

Abb.	B.-Nr.	Beschreibung	Gerätetyp	Ver.-Nr.
1	514011	Hebelgelenk/rechts	FQG-FQE (II-Serie)	1031400100
2	514012	Auslaufhahn	FR7-__G/E, FR9-__G/E (I-Serie)	1450500



Abb.	Bestell-Nr.	Beschreibung	Gerätetyp	Vergl.-Nr.
1	970352	Korb	F7-__G15/E12, F9-__G15/E12	CM030200
2	970353	Korb	F9-__G22/E18	CM030400



Abb.	Bestell-Nr.	Beschreibung	Gerätetyp	Ver.-Nr.
1	514056	Auslaufhahn	FR7-__G (II-Serie), FR9-__G (II-Serie)	1950700
2	514218	Auslaufhahn	FR7-__E (II-Serie)	1577400
3	514219	Auslaufrohr	FR9-__E (II-Serie), FR7-__G/E (II-Serie), FR9-__G/E (II-Serie)	1577500

M

Kippbratpfannen (Gas)

Passend für Mareno



Abb.	B.-Nr.	Beschreibung	Gerätetyp	Ver.-Nr.
1	104154	Brenner	BR70-7G/7GI	1685400
2	104153	Brenner	BR9-4G/GI, BR9M-4G/GI, BR9-6G/GI, BR9M-6G/GI	1475100



Abb.	Bestell-Nr.	Beschreibung	Gerätetyp	Vergl.-Nr.
1	102041	Thermoelement		90520
2	100073	Zündbrenner	BR70/7G (I-Serie)	411111
3	100703	Zündkerze		636700



Abb.	Best.-Nr.	Beschreibg.	Gerätetyp	Ver.-Nr.
1	105519	Brenner	BR7-8GF/GI	CM069900 CM069901
2	105520	Brenner	BR9-8GF/GI, BR9-8GFM/GIM	CM070003
3	105521	Brenner	BR9-12GFM, BR9-12GIM	CM070100 CM070103



Abb.	Best.-Nr.	Beschreibung	Gerätetyp	Ver.-Nr.
1	100199	Zündkabel		1152500
2	100003	Piezozünder	BR70/7G (I-Serie)	986000
3	102111	Zündgasrohr Kupfer, VPE 3m		1690200



Abb.	Bestell-Nr.	Beschreibung	Gerätetyp	Vergl.-Nr.
1	101438	Minisregler		1685500 139300
2	101137	Abdeckung	BR70/7G (I-Serie)	1393600
3	110068	Knebel		1393500
4	102102	Sensor		24021699



Abb.	Bestell-Nr.	Beschreibung	Gerätetyp	Vergleichs.-Nr.
1	101127	Elektrositregler	BR9-4G/GI, BR9-6G/GI, BR9M-4G/GI, BR9M-6G/GI	1450100
2	102247	Thermoelement		838323
3	102042	Thermoelement		2716500
4	101002	Zündgruppe		1450300



Abb.	Bestell-Nr.	Beschreibung	Gerätetyp	Vergl.-Nr.
1	101268	Winkelstück, 3/8"		1393800
2	101269	Winkelstück, 1/2"	BR70/7G (I-Serie)	1393900
3	100809	O-Ring		1394000
4	101053	Magnetspule		24021499

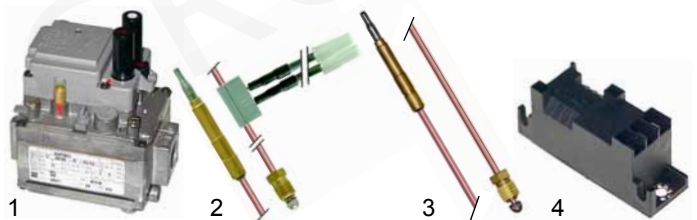

Abb.	Bestell-Nr.	Beschreibung	Gerätetyp	Vergl.-Nr.
1	100073	Zündbrenner	BR9-4G/GI, BR9-6G/GI, BR9M-4G/GI	411111
2	100703	Zündkerze	BR9M-6G/GI	636700
3	102156	Zündkabel, 400mm		1152800

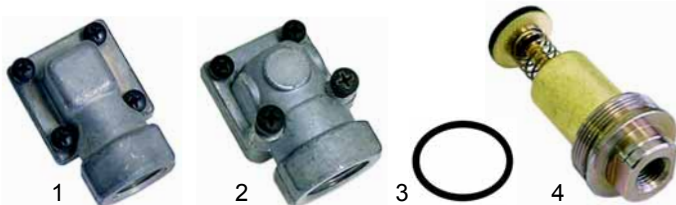

Abb.	Bestell-Nr.	Beschreibung	Gerätetyp	Vergl.-Nr.
1	101303	Flansch/gerade	BR9-4G/GI,	1451300
2	101304	Flansch/gewinkelt	BR9-6G/GI,	1451200
3	101502	O-Ring	BR9M-4G/GI, BR9M-6G/GI	24040599



Abb.	Best.-Nr.	Beschreibung	Gerätetyp	Ver.-Nr.
1	101125	Eurositregler		1887600
2	101392	Adapter		1868600
3	101390	Achse	BR70-7G/GI (II-Serie)	1905525
4	110360	Knebel		1840700
5	110437	Symbol		1804800



Abb.	Bestell-Nr.	Beschreibung	Gerätetyp	Vergleichs-Nr.
1	101352	Magnetspule	BR9-4G/GI,	
2	101312	Mikroschalter	BR9-6G/GI, BR9M-4G/GI, BR9M-6G/GI	1454900
3	101470	Sicherheitsventil	BR9-6G/GI BR9M-6G/GI	1491900



Abb.	Best.-Nr.	Beschreibung	Gerätetyp	Ver.-Nr.
1	100859	Zündbrenner		1887700
2	100701	Zündkerze		1888300
3	100186	Zündkabel	BR70-7G/GI (II-Serie)	1936300
4	100009	Piezozünder		1936100



Abb.	Bestell-Nr.	Beschreibung	Gerätetyp	Vergleichs-Nr.
1	375202	Thermostat		643800
2	300080	Vorsatzschalter	BR9-4G/GI, BR9-6G/GI,	710300
3	110386	Knebel	BR9M-4G/GI, BR9M-6G/GI	1508100
4	110635	Symbol		1322500



Abb.	Best.-Nr.	Beschreibung	Gerätetyp	Ver.-Nr.
1	101162	Novasitregler	BR9-4G/GI,	2863300
2	101391	Adapter	BR9M-4G/GI,	1923500
3	110386	Knebel	BR9SB-4G/GI, BR9M-6G/GI	1508100
4	110621	Symbol		1875100

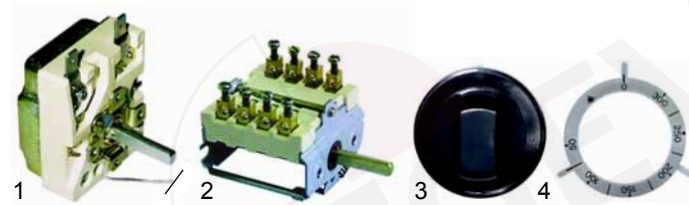

Abb.	Bestell-Nr.	Beschreibung	Gerätetyp	Vergl.-Nr.
1	359164	Signallampe/doppelt	BR9-4G/GI,	1314400
2	375194	Sicherheitsthermostat	BR9-6G/GI, BR9M-4G/GI, BR9M-6G/GI	1266500 1266514
3	345032	Mikroschalter		1267300



Abb.	Best.-Nr.	Beschreibung	Gerätetyp	Ver.-Nr.
1	101305	Flansch/gerade	BR9-4G/GI,	2865700
2	101306	Flansch/gewinkelt	BR9M-4G/GI,	2865800
3	101313	Magnetspule	BR9SB-4G/GI, BR9M-6G/GI	-
4	101317	Stecker mit Kabel		1880600



Abb.	Bestell-Nr.	Beschreibung	Gerätetyp	Vergleichs-Nr.
1	101012	Zündgruppe	BR9-4G/GI,	2971400
2	102155	Zündkabel	BR9M-4G/GI, BR9SB-4G/GI, BR9M-6G/GI	



Abb.	Bestell-Nr.	Beschreibung	Gerätetyp	Vergleichs-Nr.
1	100859	Zündbrenner	BR9-4G/GI,	1887700
2	100701	Zündkerze	BR9M-4G/GI,	1888300
3	102247	Thermoelement	BR9M-6G/GI	1955500
4	101470	Sicherheitsventil	BR9M-6G/GI	1491900



Abb.	Bestell-Nr.	Beschreibung	Gerätetyp	Vergleichs-Nr.
1	375002	Thermostat	BR9-4G/GI,	1037102300
2	550060	Bügel	BR9M-4G/GI,	921200
3	300080	Vorsatzschalter	BR9SB-4G/GI, BR9M-6G/GI	710300

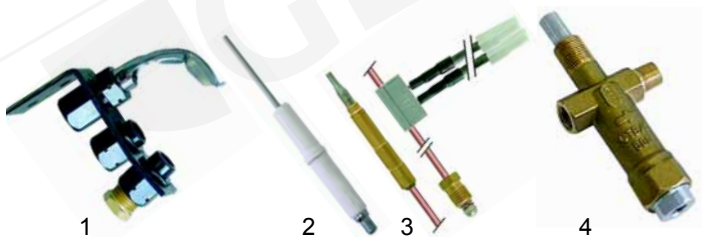

Abb.	Bestell-Nr.	Beschreibung	Gerätetyp	Vergl.-Nr.
1	110386	Knebel	BR9-4G/GI,	1508100
2	110631	Symbol	BR9M-4G/GI, BR9SB-4G/GI,	1323300
3	375187	Sicherheitsthermostat	BR9M-6G/GI	1878500

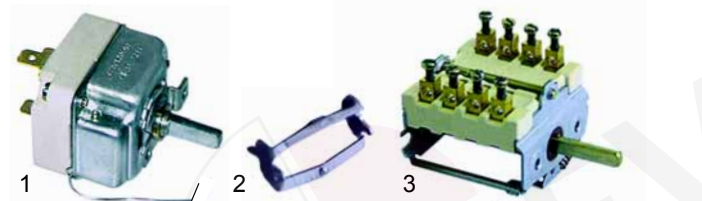

Abb.	Bestell-Nr.	Beschreibung	Gerätetyp	Vergleichs-Nr.
1	101125	Eurositregler		1887600
2	101816	Adapter	BR7-8GF,	CM057701
3	110460	Knebel	BR7-8GI	CM062401
4	102042	Thermoelement		CM029100

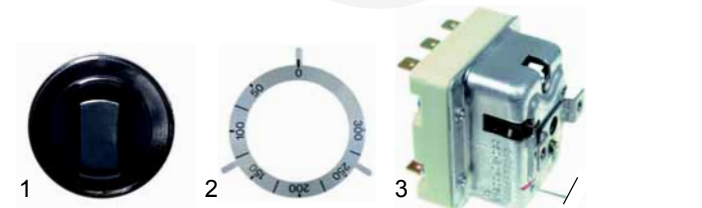

Abb.	Bestell-Nr.	Beschreibung	Gerätetyp	Vergleichs-Nr.
1	100050	Zündbrenner		CM029000
2	100701	Zündkerze	BR7-8GF,	1888300
3	100019	Zündkabel	BR7-8GI	1936400
4	100009	Piezozünder		1936100



Abb.	Bestell-Nr.	Beschreibung	Gerätetyp	Vergl.-Nr.
1	101162	Novasitregler		2863300
2	101817	Adapter	BR9-8GF/GI, BR9-__GFM/GIM, BR9S-8GF/GI	CM091301 CM091302
3	110440	Knebel		CM061501
4	102247	Thermoelement		1950100



Abb.	Bestell-Nr.	Beschreibung	Gerätetyp	Ver.-Nr.
1	100050	Zündbrenner		CM029000
2	100701	Zündkerze	BR9-8GF/GI,	1949900
3	100019	Zündkabel	BR9-__GFM/GIM, BR9S-8GF/GI	1936400
4	100009	Piezozünder		1936100



Abb.	Best.-Nr.	Beschreibung	Gerätetyp	Vergl.-Nr.
1	375002	Thermostat	BR9-8GF/GI,	1037102300
2	300080	Vorsatzschalter	BR9-__GFM/GIM,	710300
3	110998	Knebel	BR9S-8GF/GI	CM059800

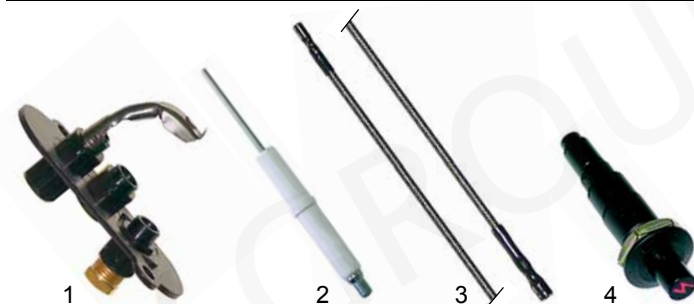

Abb.	Bestell-Nr.	Beschreibung	Gerätetyp	Vergl.-Nr.
1	300102	Schalter		1475900
2	110360	Knebel		1840700
3	110604	Symbol	BR70-7E (I-Serie)	1229000
4	359142	Signallampe/grün		21016199
5	359143	Signallampe/gelb		21016299



Abb.	B.-Nr.	Beschreibung	Gerätetyp	Vergl.-Nr.
1	375187	Sicherheitsthermostat	BR9-8GF/GI,	1878500
2	359140	Signallampe	BR9-__GFM/GIM, BR9S-8GF/GI	1037300910



Abb.	Bestell-Nr.	Beschreibung	Gerätetyp	Vergl.-Nr.
1	375192	Thermostat		1309100
2	110386	Knebel	BR9-4E, BR9-6E	1508100
3	110631	Symbol		1323300

Kippbratpfannen (Elektro)

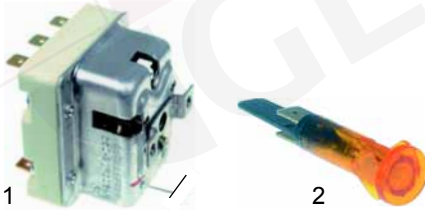

Abb.	Bestell-Nr.	Beschreibung	Gerätetyp	Vergl.-Nr.
1	415973	2700W/230V	BR70-7E, BR7-8E	1686900 1685100
2	415084	3900W/230V	BR9-4E, BR9-8E	1878700 1475600
3	415987	5850W/230V	BR9-6E, BR9-12E	1493800 1878800



Abb.	Bestell-Nr.	Beschreibung	Gerätetyp	Vergl.-Nr.
1	300102	Schalter		1475900
2	110386	Knebel	BR9-4E, BR9-6E	1508100
3	110624	Symbol		1323700
4	359164	Signallampe		1314400

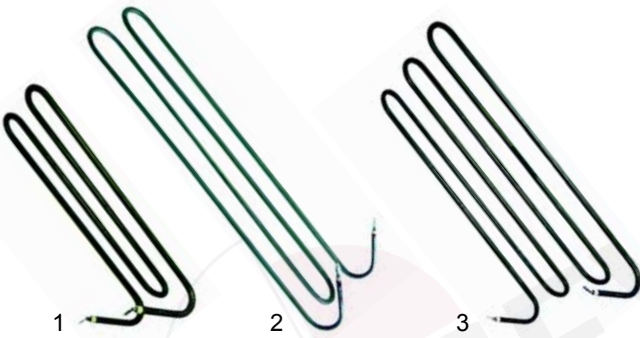

Abb.	Bestell-Nr.	Beschreibung	Gerätetyp	Vergl.-Nr.
1	375192	Thermostat		1309100
2	110360	Knebel	BR70-7E (I-Serie)	1840700
3	110614	Symbol		1840400



Abb.	Bestell-Nr.	Beschreibung	Gerätetyp	Vergleichs-Nr.
1	375002	Thermostat	BR70-7E/7E1 (II-Serie)	1037102300
2	550060	Bügel	BR9-4/6 (II-Serie)	1998500 921200
3	300001	Vorsatzschalter	BR9-8__/12__	1037313200

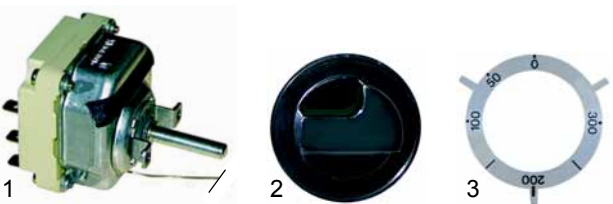

Abb.	Bestell-Nr.	Beschreibung	Gerätetyp	Vergl.-Nr.
1	110360	Knebel	BR70-7E/7EI (II-Serie)	1840700
2	110614	Symbol		1840400
3	345144	Grenzschalter		1871500



Abb.	Bestell-Nr.	Beschreibung	Gerätetyp	Vergl.-Nr.
1	110386	Knebel	BR9-4_/6_ (II-Serie)	1508100
2	110631	Symbol		1323300
3	110998	Knebel	BR7- BR9-8_/6_	CM059800
4	359140	Signallampe/gelb		1037300910

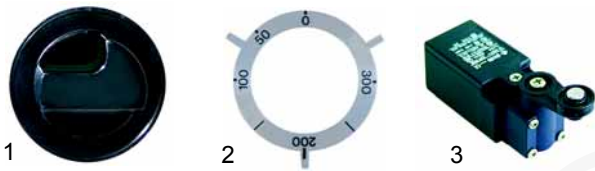

Abb.	Bestell-Nr.	Beschreibung	Gerätetyp	Vergl.-Nr.
1	375187	Sicher.-thermostat	Universal	1878500
2	380213	Schütz		CM187300 21453199
3	380261	Schütz		CM187400 21453599

Kippbratpfannen (Mechanik)

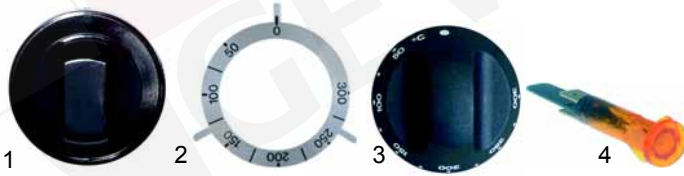

Abb.	Bestell-Nr.	Beschreibung	Gerätetyp	Vergl.-Nr.
1	514028	Tiegel-Scharnier	BR70- BR9-	1488600
2	514029	Scharnierwelle		1488800
3	514030	Seegering		15901700



Abb.	Bestell-Nr.	Beschreibung	Gerätetyp	Vergl.-Nr.
1	514223	Einstellbuchse	BR70- BR9-	291100
2	514224	Scharnierhalter		1489000
3	514225	Buchse		290900
4	514226	Deckelfeder		139732



Abb.	Bestell-Nr.	Beschreibung	Gerätetyp	Vergl.-Nr.
1	514227	Einstellbuchse/rechts	BR70- BR9- (Protagonista)	CM051604
2	514228	Scharnierhalter/rechts		CM192401
3	514229	Buchse/rechts		CM192101
4	514232	Buchse/links		CM051403
5	514230	Scharnierhalter/links		CM051903
6	514231	Einstellbuchse/links		CM051503



Abb.	Bestell-Nr.	Beschreibung	Gerätetyp	Vergl.-Nr.
1	514226	Deckelfeder/außen	BR70- BR9- (Protagonista)	139732
2	514234	Deckelfeder/Mitte		810210



Abb.	Bestell-Nr.	Beschreibung	Gerätetyp	Vergl.-Nr.
1	514235	Kippvorrichtung kpl.	BR70-	1687600
2	514023	Mutter, M20, links		1685800
2	514024	Mutter, M20, rechts		1688000
3	514026	Handrad		1685600 1685691



Abb.	Bestell-Nr.	Beschreibung	Gerätetyp	Vergl.-Nr.
1	514236	Kippvorrichtung kpl.	BR9-	1478432
2	514023	Mutter, M20, links		1685800
2	514024	Mutter, M20, rechts		1688000
3	690086	Handrad		1475200
4	n.m.l.	Mutter, M24	BR9- (I-Serie)	1479000



Abb.	Bestell-Nr.	Beschreibung	Gerätetyp	Vergl.-Nr.
1	514237	Mutter	BR7 (Protagonist) BR9 (Protagonist)	CM184300
2	514238	Welle	BR7 (Protagonis)	CM199100
3	514239	Welle	BR9 (Protagonist)	CM199200
4	514240	Buchse		CM184500
5	514241	Welle Handrad	BR7 (Protagonist) BR9 (Protagonist)	CM184800
6	690086	Handrad		CM1475291

Kochkessel (Gas)



Abb.	Bestell-Nr.	Beschreibung	Gerätetyp	Ver.-Nr.
1	105276	Brennerdeckel P__70G-7G P9__-5G		1205900 1104400
2	105277	Brennerkörper		1104300
3	104151	Brenner	P9__-10G/15G (I-Serie)	1413000
4	104244	Brenner	P9__-10G (II-Serie)	27085-14



Abb.	Bestell-Nr.	Beschreibung	Gerätetyp	Vergl.-Nr.
1	105522	Brenner	P__-6G5	CM088200
2	105523	Brenner	P__-8G10/14/15	CM088100



Abb.	Bestell-Nr.	Beschreibung	Gerätetyp	Vergleichs-Nr.
1	101089	Gashahn		1337200
2	110364	Knebel	PD70-7G (I-Serie)	1840900
3	110601	Symbol		1842000



Abb.	Bestell-Nr.	Beschreibung	Gerätetyp	Vergl.-Nr.
1	102041	Thermoelement	PD70-7G (I-Serie)	90520
2	102110	Zündgasrohr Kupfer (VPE 3 m)		1682300



Abb.	Bestell-Nr.	Beschreibung	Gerätetyp	Vergleichs-Nr.
1	101060	Magnetspule		24030199
2	101230	Magnetmutter	PD70-7G (I-Serie)	24030299
3	101260	Schlitzschraube		1359100
4	101246	Doppelkonus, 4mm		673600
5	100908	Schraube, M10		673500

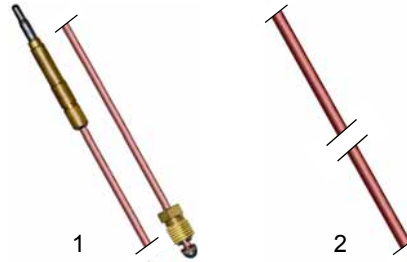

Abb.	Best.-Nr.	Beschreibung	Gerätetyp	Vergl.-Nr.
1	101248	Doppelkonus, 12mm		673100
2	101251	Ü-Mutter, M20		673300
3	100907	Thermoel.-Schraube	PD70-7G (I-Serie)	24010899
4	101292	Zündkerzenschraube für Zündbrenner		636600
5	101282	Doppelkonus		469000
6	101283	Schraube, M10		468800



Abb.	Bestell-Nr.	Beschreibung	Gerätetyp	Vergleichs-Nr.
1	101437	Minisregler	PI70-7G	1393300 1677300
2	101137	Abdeckkappe		1393600
3	110068	Knebel		1393500



Abb.	Bestell-Nr.	Beschreibung	Gerätetyp	Vergleichs-Nr.
1	102247	Thermoelement	PI70-7G	838323
2	390061	Sicher.-thermostat		732913
3	101053	Magnetspule		24021499



Abb.	Bestell-Nr.	Beschreibung	Gerätetyp	Vergl.-Nr.
1	101127	Elletrositregler	P9I-10G	1450100
2	102042	Thermoelement		2716500
3	102011	Thermoelemnetverlängerung, 400mm		933400

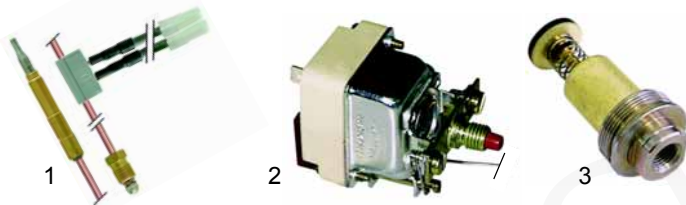

Abb.	Bestell-Nr.	Beschreibung	Gerätetyp	Vergleichs-Nr.
1	100073	Zündbrenner	PD70-7G PI70-7G	509900
2	100703	Zündkerze		636700
3	100199	Zündkabel		1152500
4	100003	Piezozünder		986000



Abb.	Bestell-Nr.	Beschreibung	Gerätetyp	Vergl.-Nr.
1	100046	Zündbrenner	P9I-10G	10405-11
2	100706	Zündkerze		224211
3	102157	Zündkabel, 1200mm		1152900
4	101002	Zündgruppe		1450300

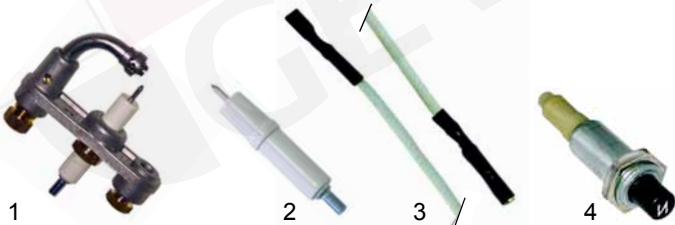

Abb.	Bestell-Nr.	Beschreibung	Gerätetyp	Vergleichs-Nr.
1	101093	Gashahn	P9D-10G/15G	1345300
2	110388	Knebel		1322200
3	110620	Symbol		1322300

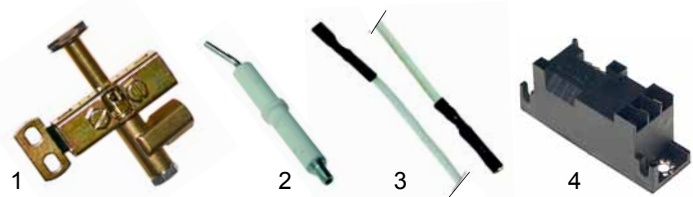

Abb.	Bestell-Nr.	Beschreibung	Gerätetyp	Vergleichs-Nr.
1	390046	Thermostat	P9I-10G	1450200
2	300080	Vorsatzschalter		710300
3	110386	Knebel		1508100
4	110632	Symbol		1875300



Abb.	Best.-Nr.	Beschreibung	Gerätetyp	Ver.-Nr.
1	102044	Thermoelement, 1200mm	P9D-10G/15G	263800
2	102110	Zündgasrohr Kupfer (VPE 3 m)		1413100 1413200

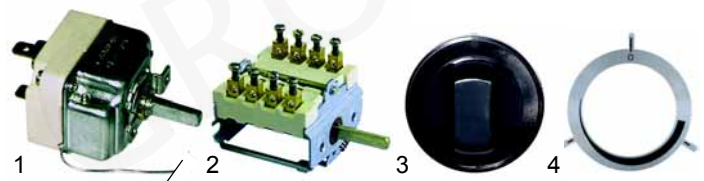

Abb.	Bestell-Nr.	Beschreibung	Gerätetyp	Vergl.-Nr.
1	101086	Gashahn	PD70-7G (II-Serie)	188860
2	110364	Knebel		1840900
3	110601	Symbol		1842000
4	102042	Thermoelement, 850mm		1916000

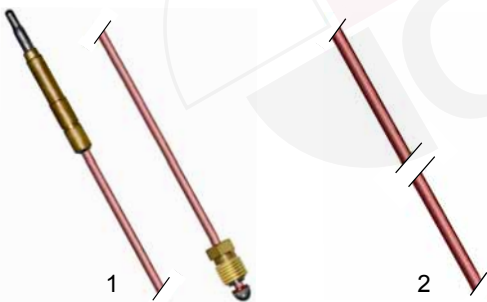

Abb.	Bestell-Nr.	Beschreibung	Gerätetyp	Vergl.-Nr.
1	101262	Schlitzschraube, M10	P9D-10G/15G	1162800
2	101256	Doppelkonus 16		1127400
3	101253	Ü.-Mutter M24/16		1421000
4	101257	Doppelkonus 20		1347000
5	101254	Ü.-Mutter M28/20		1346900

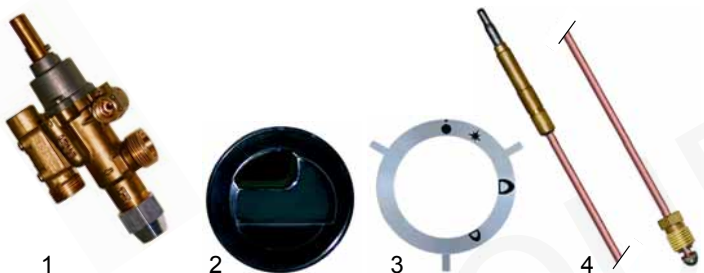

Abb.	Bestell-Nr.	Beschreibung	Gerätetyp	Vergleichs-Nr.
1	101437	Minisitregler	PI70-7G (II-Serie)	1677314
2	101137	Abdeckkappe	P9I-5G	1693600
3	110068	Knebel		1693500

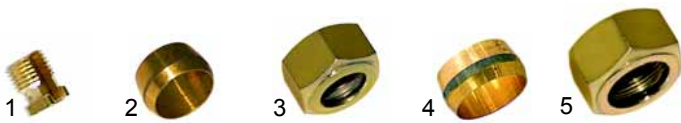

Abb.	Best.-Nr.	Beschreibung	Gerätetyp	Ver.-Nr.
1	100859	Zündbrenner	PD70-7G (II-Serie)	1887700
2	100701	Zündkerze	PI70-7G (II-Serie)	1888300
3	100019	Zündkabel	P9I-5G	1936400
4	100009	Piezozünder	P9D-10G/15G (II-Serie)	1936100

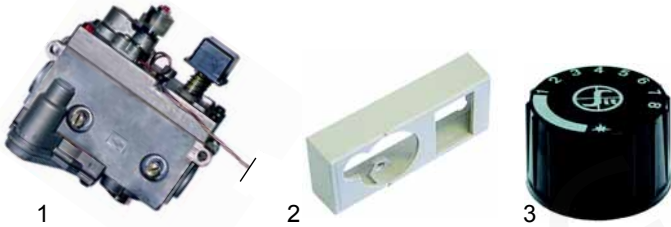

Abb.	Bestell-Nr.	Beschreibung	Gerätetyp	Vergl.-Nr.
1	102247	Thermoelement	PI70-7G (II-Serie)	1955500
2	375358	Sicherh.-thermostat	P9I-5G	1871100



Abb.	Bestell-Nr.	Beschreibung	Gerätetyp	Vergleichs-Nr.
1	101187	Novasitregler		1870800
2	101391	Adapter	P9I-10G	1923500
3	110386	Knebel		1508100
4	110621	Symbol		1875100

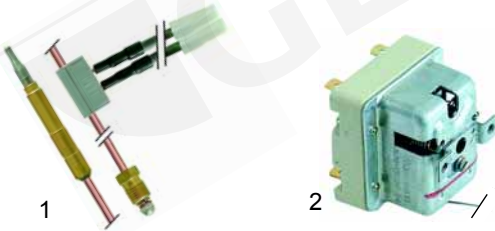

Abb.	Bestell-Nr.	Beschreibung	Gerätetyp	Vergleichs-Nr.
1	101086	Gashahn		1888600
2	110388	Knebel	P9D-5G	1322200
3	110620	Symbol		1322300
4	102042	Thermoelement		1916000



Abb.	Bestell-Nr.	Beschreibung	Gerätetyp	Vergl.-Nr.
1	102238	Thermoelement		1949800
2	102116	Generator	P9I-10G	1870712
3	375358	Sicherheitsthermostat		1871100



Abb.	Bestell-Nr.	Beschreibung	Gerätetyp	Vergl.-Nr.
1	101093	Gashahn		1954600
2	110388	Knebel	P9D-10G/15G (II-Serie)	1322200
3	110620	Symbol		1322300
4	102044	Thermoelement		263800



Abb.	Bestell-Nr.	Beschreibung	Gerätetyp	Vergleichs-Nr.
1	100110	Zündbrenner		1949700
2	100701	Zündkerze	P9I-10G	1949900
3	100195	Zündkabel		1950312 1950324
4	100009	Piezozünder		1936100



Abb.	Bestell-Nr.	Beschreibung	Gerätetyp	Vergleichs-Nr.
1	375198	Thermostat	P9I-10G	1873500
2	110386	Knebel		1508100
3	110632	Symbol		1875300



Abb.	Bestell-Nr.	Beschreibung	Gerätetyp	Vergleichs-Nr.
1	101086	Gashahn	PD7-6G5 PD9-6G5	1888600
2	110993	Knebel		CM061600
3	102042	Thermoelement		CM029100



Abb.	Bestell-Nr.	Beschreibung	Gerätetyp	Vergleichs-Nr.
1	101188	Eurositregler	PI7-6G5 PI9-6G5	CM097000
2	101816	Adapter		CM057700 CM057701
3	110415	Knebel		CM062301



Abb.	Bestell-Nr.	Beschreibung	Gerätetyp	Vergleichs-Nr.
1	102247	Thermoelement		1950100
2	375359	Sich.-thermostat		CM097700



Abb.	Bestell-Nr.	Beschreibung	Gerätetyp	Vergl.-Nr.
1	101093	Gashahn	PD9-8G10/15 PI9-8G10/14	1954600
2	110993	Knebel		CM061600
3	102042	Thermoelement		CM029100

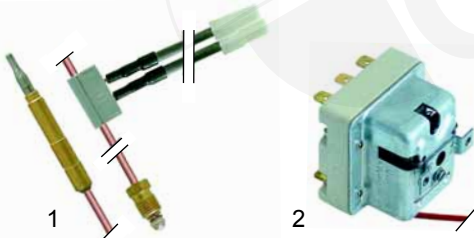

Abb.	B.-Nr.	Beschreibung	Gerätetyp	Ver.-Nr.
1	375331	Thermostat mit Vorsatzschalter	PI9-8G10/14	CM097800
2	110410	Knebel		CM062200
3	101189	Tandemregler		29426001



Abb.	Bestell-Nr.	Beschreibung	Gerätetyp	Vergleichs-Nr.
1	100109	Zündbrenner	PD7- PI7- PD9- PI9- —	CM040800
2	100701	Zündkerze		1888300
3	100019	Zündkabel		1936400
4	100009	Piezozünder		1936100
5	101818	Abdeckkappe		CM136000

Kochkessel (Elektro)



Abb.	Bestell-Nr.	Beschreibung	Gerätetyp	Vergleichs-Nr.
1	415994	3400W/ 3x230V	PI70-7E	1677000 1878100
2	521115	Dichtung		2604100
3	415984	6000W/ 3x230V	P9I-10E	1878200 1414300
4	521116	Dichtung		1422200



Abb.	Bestell-Nr.	Beschreibung	Gerätetyp	Vergleichs-Nr.
1	416815	7500W/ 3x230V	P9I-15E	1878300
2	521116	Dichtung		1422200
3	416816	2000W/ 230V	P9D-10E/ 15E	1414400 1879000
4	416817	4000W/ 230V	PD9-8E10/15	CM096301



Abb.	Bestell-Nr.	Beschreibung	Gerätetyp	Vergleichs-Nr.
1	416818	3400W/ 3x230V	PI7-6E5	CM183900
2	521146	Dichtung	PI9-6E5	CM046200
3	416819	7500W/ 3x230V	PI9-8E10/15	CM182300
4	521115	Dichtung		2604100

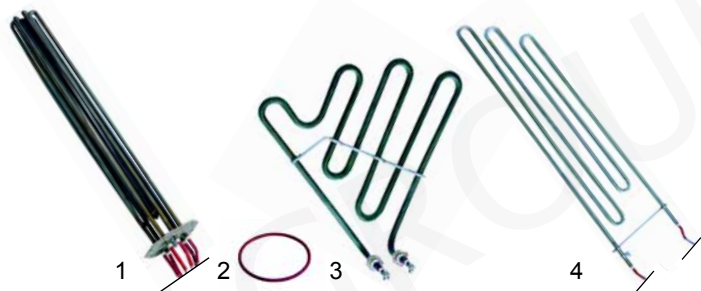

Abb.	Bestell-Nr.	Beschreibung	Gerätetyp	Vergleichs-Nr.
1	375410	Thermostat	PI70-7E	1616000
2	110360	Knebel	(I-Serie)	1840700
3	110612	Symbol		1840600



Abb.	Bestell-Nr.	Beschreibung	Gerätetyp	Vergleichs-Nr.
1	300021	Schalter	PI70-7E	1230100
2	110360	Knebel	(I-Serie)	1840700
3	110604	Symbol		1229000



Abb.	Bestell-Nr.	Beschreibung	Gerätetyp	Vergl.-Nr.
1	390168	Sicherheitsthermostat	PI70-7E	733100
2	359142	Signallampe grün	(I-Serie)	1819800
3	359143	Signallampe gelb		1819900



Abb.	Bestell-Nr.	Beschreibung	Gerätetyp	Vergleichs-Nr.
1	345710	Schalter	P9D-10E/15E	1419700
2	110386	Knebel	(I-Serie)	1508100
3	110627	Symbol		1966800



Abb.	Bestell-Nr.	Beschreibung	Gerätetyp	Vergleichs-Nr.
1	390046	Thermostat	P9I-10E	1450200
2	300080	Vorsatzschalter		710300
3	110386	Knebel		1508100
4	110629	Symbol		1322900

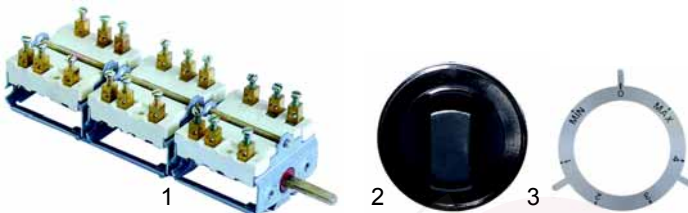

Abb.	Bestell-Nr.	Beschreibung	Gerätetyp	Vergl.-Nr.
1	390061	Sicherheitsthermostat	P9I-10E	732913
2	380261	Schütz		21452399
3	359160	Signallampe/grün		1230300
4	359159	Signallampe/gelb		912800



Abb.	Bestell-Nr.	Beschreibung	Gerätetyp	Vergleichs-Nr.
1	375198	Thermostat	PI70-7E	1873500
2	300001	Vorsatzschalter	(II-Serie)	1037313200
3	110360	Knebel		1840700
4	110612	Symbol		1840600



Abb.	Bestell-Nr.	Beschreibung	Gerätetyp	Vergl.-Nr.
1	375198	Thermostat	P9I-5E/10E/15E	1873500
2	300001	Vorsatzschalter		1037313200
3	110386	Knebel		1508100
4	110632	Symbol		1875300



Abb.	Bestell-Nr.	Beschreibung	Gerätetyp	Vergl.-Nr.
1	375189	Sicherheitsthermostat		1878600
2	380213	Schütz	PI70-7E (II-Serie)	21453199
3	359139	Signallampe grün	P9I-5E	1037300810
4	359140	Signallampe gelb		1037300910

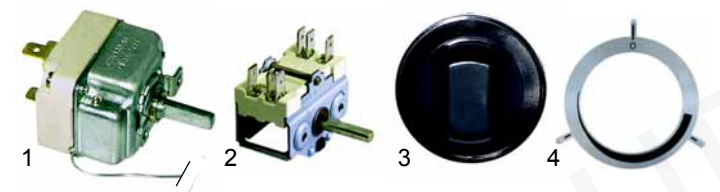

Abb.	B.-Nr.	Beschreibung	Gerätetyp	Ver.-Nr.
1	375331	Thermostat, mit Vorsatzschalter	PI7-6E5	CM097800
2	110410	Knebel	PI9-6E5 PI9-8E10/15	CM62200
3	380015	Energiregler	PD9-8E10/15	426710
4	110995	Knebel		CM062500



Abb.	Bestell-Nr.	Beschreibung	Gerätetyp	Vergl.-Nr.
1	375358	Sicherheitsthermostat		1871100
2	380261	Schütz	P9I-10E/15E	21453599
3	110139	Signallampe grün		1037300810
4	110140	Signallampe gelb		1037300910



Abb.	Bestell-Nr.	Beschreibung	Gerätetyp	Vergl.-Nr.
1	375359	Sicherheitsthermostat	PI7-6E5	CM097700
2	380213	Schütz	PI9-6E5	CM187300
3	380261	Schütz	PI9-8E10/15 PD9-8E10/15	CM187400
4	359140	Signallampe gelb		1037300910



Abb.	Bestell-Nr.	Beschreibung	Gerätetyp	Vergleichs-Nr.
1	380015	Energiregler		426710
2	110386	Knebel	P9D-10E/15E	1508100
3	110627	Symbol		1966800

Kochkessel (Mechanik)

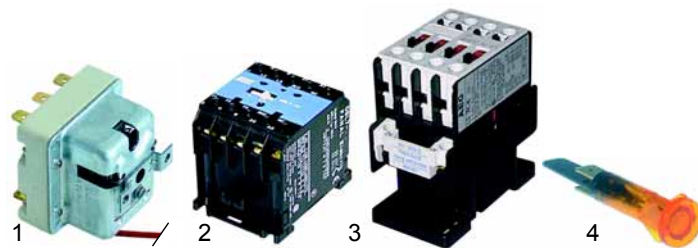

Abb.	Bestell-Nr.	Beschreibung	Gerätetyp	Vergl.-Nr.
1	540132	Entleerhahn 1 1/4"	PD70-7G PI70-7G/E P9_-5G/E	1677800 1677200
2	540275	Entleerhahn 2"	P9_-10G/E P9_-15G/E PD-10G/15G PI-10G/15G/10E	679400 679412



Abb.	Bestell-Nr.	Beschreibung	Gerätetyp	Vergl.-Nr.
1	375187	Sicherheitsthermostat		1878500
2	380261	Schütz	P9D-10E/15E	21453599
3	359139	Signallampe grün		1037300810
4	359140	Signallampe gelb		1037300910



Abb.	Bestell-Nr.	Beschreibung	Gerätetyp	Ver.-Nr.
1	540721	Sicherheitsventil, 1 1/4"		14206200 14206299
2	540827	Be- + Entlüfter 3/4"	PI-10G, PI-15G, PI-10E	14206399
3	540836	Trichter		14206599

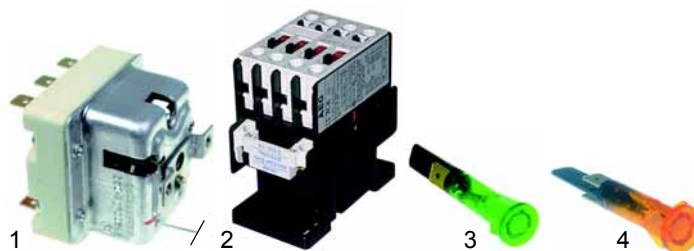

Abb.	Bestell-Nr.	Beschreibung	Gerätetyp	Vergl.-Nr.
1	514242	Mischbatterie	P9D-_, P9I-__	450100
2	514243	Einlaufrohr	P9D-_, P9I-__, PD9-_, PI9-__	450000

Abb.	Bestell-Nr.	Beschreibung	Gerätetyp	Vergleichs-Nr.
1	514060	Einlaufhahn		CM127800
2	514061	Knebel		CM143100
3	514245	Knebel		CM143200



Abb.	Bestell-Nr.	Beschreibung	Gerätetyp	Ver.-Nr.
1	514244	Oberteil		955600
2	514053	Griff	P9D-_, P9I-__	832400
3	514246	Scheibe/rot		677700
4	514247	Scheibe/blau		675100



Abb.	Bestell-Nr.	Beschreibung	Gerätetyp	Vergleichs-Nr.
1	300084	Wahlschalter		2464600
2	375201	Thermostat	CON_G/GP	2992900
3	111500	Knebel	CON_E/EP	2795000
4	359004	Signallampe grün	CSM_G/EP	2998600
5	359005	Signallampe gelb	CSM_E/EP	2998700

Komponenten (Elektro)



Abb.	Bestell-Nr.	Beschreibung	Gerätetyp	Vergl.-Nr.
1	345335	Magnetschalter		51691.00
2	345336	Magnet	CON_	51692.00
3	375206	Sicherheitsthermostat	CSM_	28647.14

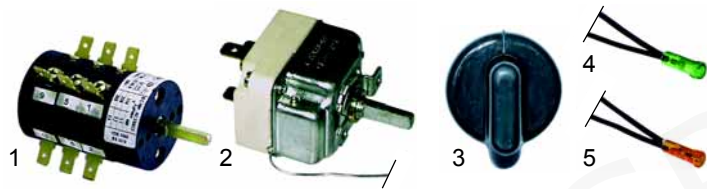

Abb.	Bestell-Nr.	Beschreibung	Gerätetyp	Vergleichs-Nr.
1	380015	Energeregler	CON_	426710
2	360331	Timer		2971100
3	350033	Timer	CSM_	5151600



Abb.	Bestell-Nr.	Beschreibung	Gerätetyp	Vergl.-Nr.
1	360332	Timer	CON 6/10/102_	2971200
2	350034	Timer	CON 201/202_	5151700
3	350078	Summer	CSN_	2864400
4	350079	Summer	CON 201/202_	5152000
			CSN_	

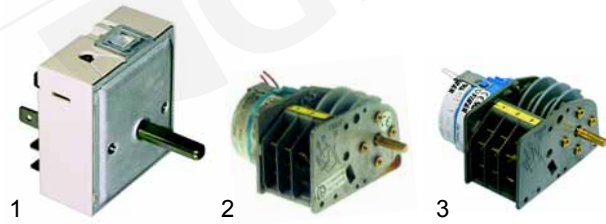

Abb.	Bestell-Nr.	Beschreibung	Gerätetyp	Vergleichs-Nr.
1	345525	Kontaktblock No		2959000
2	345562	Kontaktblock Nc	CON_	2959100
3	345482	Halterung	CSM_	2860700
4	345526	Wahlschalter		2860600

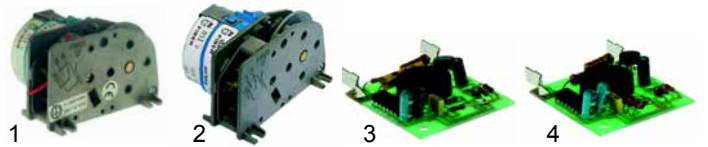

Abb.	Bestell-Nr.	Beschreibung	Gerätetyp	Vergl.-Nr.
1	401151	Transformator	CON 6/10/102_	5159300
2	401152	Transformator	CSM 6/10/102_	5153000
3	401153	Transformator	_201/202_	5153100

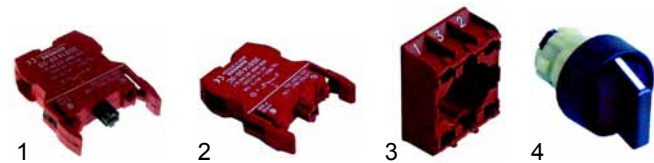

Abb.	Bestell-Nr.	Beschreibung	Gerätetyp	Vergleichs-Nr.
1	346330	Kontaktblock		2860900
2	345482	Halterung	CON_G/GP	2860700
3	346331	Lampe	CSM_G/GP	2964800
4	346332	Taster		2964900



Abb.	Bestell-Nr.	Beschreibung	Gerätetyp	Vergl.-Nr.
1	380341	Socket	CON 6/10/102	2998500
2	380382	Relais		2998400
3	380340	Socket	CON 201/202	5151400
4	380331	Relais	CSM_	5151300

Kerntemperatur

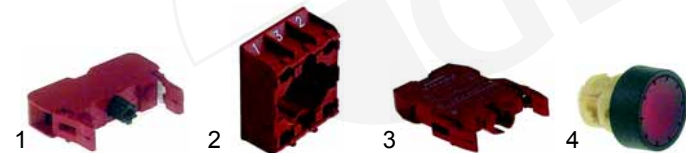

Abb.	Bestell-Nr.	Beschreibung	Gerätetyp	Vergleichs-Nr.
1	379565	Elektronikregler	Universal	2959300
2	379137	Fühler PT100	_6/10/102_	5158100
2	379138	Fühler PT100	_201/202_	5154600

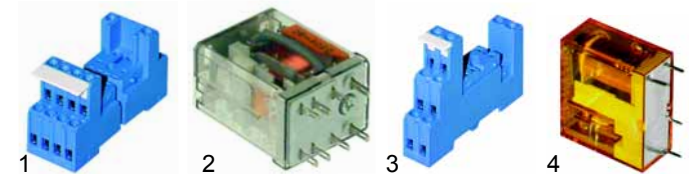

Abb.	Bestell-Nr.	Beschreibung	Gerätetyp	Vergl.-Nr.
1	375208	Sich.-thermostat, 132°C Boiler	CSM_	2865100
2	375207	Thermostat 65°C fest		5169800
3	n.m.l.	Niveauregler		2928500



Abb.	Bestell-Nr.	Beschreibung	Gerätetyp	Vergl.-Nr.
1	401154	Elektrode, 125mm	CSM 06 G/GP	2911600
2	401155	Elektrode, 132mm		2911700
3	401156	Elektrode, 150mm		2911800

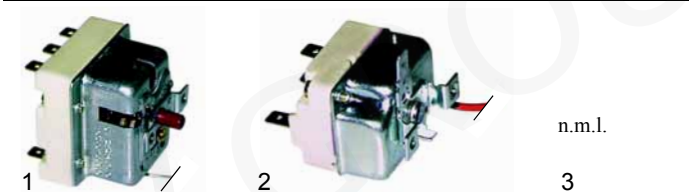

Abb.	Bestell-Nr.	Beschreibung	Gerätetyp	Vergl.-Nr.
1	401164	Elektrode, 144mm	CSM 10 E/EP	2899600
2	401156	Elektrode, 150mm		2911800
3	401165	Elektrode, 163mm		2899800

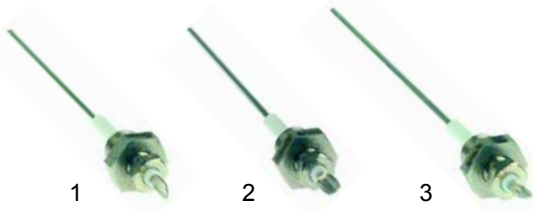

Abb.	Bestell-Nr.	Beschreibung	Gerätetyp	Vergl.-Nr.
1	401157	Elektrode, 150mm	CSM 10 G/GP	2908300
2	401158	Elektrode, 158mm	CSM 102 E/EP	2908200
3	401159	Elektrode, 186mm	CSM 201 E/EP	2987000



Abb.	Bestell-Nr.	Beschreibung	Gerätetyp	Vergl.-Nr.
1	401157	Elektrode, 150mm	CSM 201 E/EP CSM 202 E/EP	2908300
2	401158	Elektrode, 158mm		2908200
3	401160	Elektrode, 185mm		2908100



Abb.	Bestell-Nr.	Beschreibung	Gerätetyp	Vergl.-Nr.
1	401160	Elektrode, 185mm	CSM 102 G/GP	2908100
2	401159	Elektrode, 186mm	CSM 201 G/GP	2987000
3	401161	Elektrode, 210mm	CSM 202 G/GP	2927500

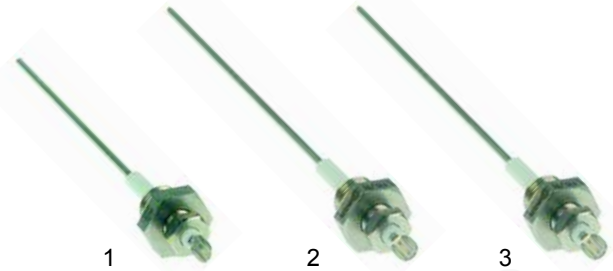

Abb.	Bestell-Nr.	Beschreibung	Gerätetyp	Vergl.-Nr.
1	370017	Magnetventil, 230V	CON 6 __ CON 10 __ CON 102 __	2709000
1	370029	Magnetventil, 24V	CON 201 __ CON 202 __ CSM __	2956900
2	370109	Magnetventil, 24V	CSM 201 __ CSM 202 __	5151500



Abb.	Bestell-Nr.	Beschreibung	Gerätetyp	Vergl.-Nr.
1	401162	Elektrode, 128mm	CSM 6 E/EP	2916100
2	401163	Elektrode, 135mm		2916200
3	401156	Elektrode, 150mm		2911800



Abb.	Bestell-Nr.	Beschreibung	Gerätetyp	Vergleichs-Nr.
1	415997	9000W/400V	_6 E/EP	5152400
2	415998	3000W/400V	_10 E/EP _201 E/EP	5152100
3	415999	5000W/400V	_102 E/EP _202 E/EP	5152200

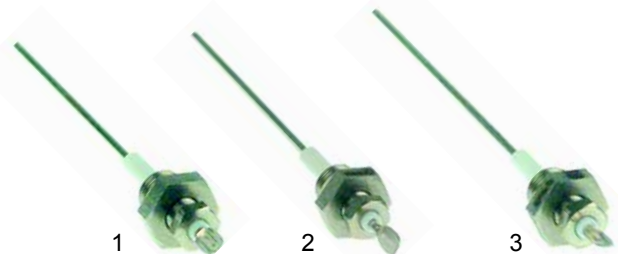

Abb.	Bestell-Nr.	Beschreibung	Gerätetyp	Vergleichs-Nr.
1	415957	9000W/400V	CSM_E/EP	5152300
2	510408	Dichtung		-

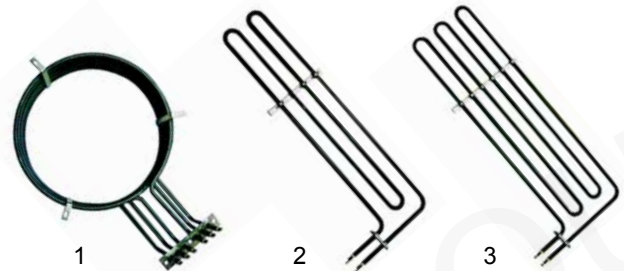

Abb.	Bestell-Nr.	Beschreibung	Gerätetyp	Vergleichs-Nr.
1	359713	Lampenfassung	Universal	2861900
2	359612	Lampe		
3	359714	Dichtung		
4	359715	Glas		
5	359716	Rahmen		

Motoren



Abb.	Bestell-Nr.	Beschreibung	Gerätetyp	Vergl.-Nr.
1	500130	Motor 230V	CON_ CSM_ nur 6x1/1-Geräte	5186500
2	500131	Motor 230V	(Außer 6x1/1) CON_ G/GP CSM_ G/GP	5163900
3	500132	Motor 400V	(Außer 6x1/1) CON_ E/EP CSM_ E/EP	5183900

Lüfterräder



Abb.	Bestell-Nr.	Beschreibung	Gerätetyp	Vergleichs-Nr.
1	514036	Ø220mm	_6_	2861600
2	514037	Ø338mm	_10_	2919900



Abb.	Bestell-Nr.	Beschreibung	Gerätetyp	Vergleichs-Nr.
1	514038	Ø350mm	_102_ _201_	2939414
2	514039	Ø350mm	_202_	5103414
3	514040	Wellendichtung	Universal	2835600

Komponenten (Gas)

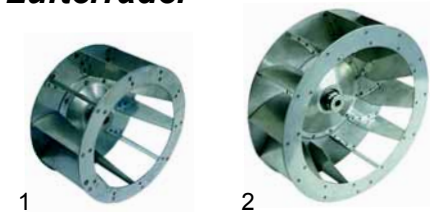

Abb.	Bestell-Nr.	Beschreibung	Gerätetyp	Vergleichs-Nr.
1	105730	Brenner Heißluft	6 G/GP	2862914
2	105731	Brenner Heißluft	10 G/GP	2862500
3	105732	Brenner Heißluft	102 G/GP 201 G/GP	2933500
4	105733	Brenner Heißluft	202 G/GP	5102300



Abb.	Bestell-Nr.	Beschreibung	Gerätetyp	Vergl.-Nr.
1	105734	Brenner Boiler	CSM 6G/GP	2862614
2	105735	Brenner Boiler	CSM 10G/GP	5163800
3	105736	Brenner Boiler	CSM 102G/GP CSM 201G/GP	2947600
4	105737	Brenner Boiler	CSM 202G/GP	5102400



Abb.	Bestell-Nr.	Beschreibung	Gerätetyp	Vergleichs-Nr.
1	101189	Tandem-Ventil	_6G/GP_ _10G/GP_	2942600
2	101967	Novasit-Ventil	_102G/GP_ _201G/GP_ _202G/GP_	5118500

Türdichtungen



Abb.	Bestell-Nr.	Beschreibung	Gerätetyp	Vergleichs-Nr.
1	900106	645x490mm	_6_	2885900
2	900107	645x740mm	_10_ _102_	2891900
3	900108	720x1460mm	_201_ _202_	5113500



Abb.	Bestell-Nr.	Beschreibung	Gerätetyp	Vergl.-Nr.
1	541051	Pressostat		5151000
2	102324	Zündelektrode	_G/GP	5149900
3	102325	Überwachungselektrode		5126900

Komponenten (Mechanik)

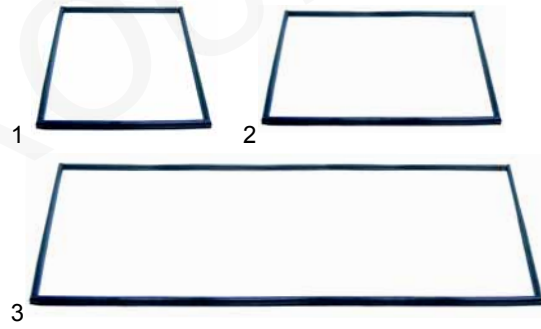

Abb.	Bestell-Nr.	Beschreibung	Gerätetyp	Vergleichs-Nr.
1	700060	Türgriff	_6_	2872000
2	700061	Kloben	_10_ _102_	5129900

Fensterdichtungen



Abb.	Bestell-Nr.	Beschreibung	Gerätetyp	Ver.-Nr.
1	900435	2350mm	_6_	2885800
2	900436	2170mm	_10_ , _102_	2891700
3	900437	10m	_201_ , _202_	2838000
4	900438	Doppelglasdichtung		5109600



Abb.	Bestell-Nr.	Beschreibung	Gerätetyp	Vergleichs-Nr.
1	690399	Griff		5156100
2	690042	Getriebe	_201_ _202_	5154800
3	690041	Riegelstück		5145100
4	690040	Kloben		5156000

M

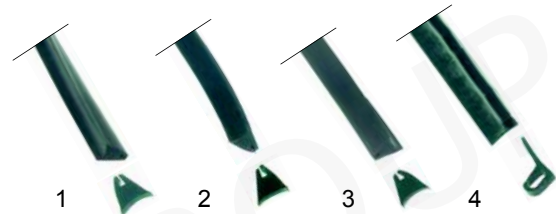
Passend für Mareno

Hockerkocher (Gas)

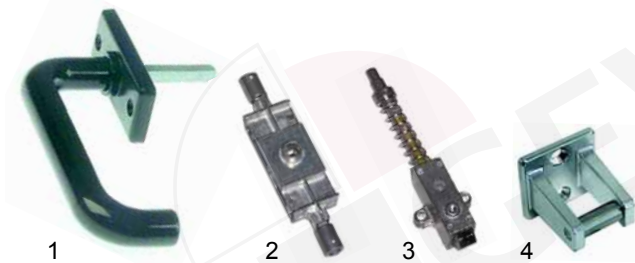

Abb.	Bestell-Nr.	Beschreibung	Gerätetyp	Vergleichs-Nr.
1	105276	Brennerdeckel	FP165	1205900
2	105277	Brenner		1104300
3	105278	Dichtung		1104600 1104612



Abb.	Bestell-Nr.	Beschreibung	Gerätetyp	Vergleichs-Nr.
1	100095	Zündbrenner	FP165	1887700
2	100701	Zündkerze		1888300
3	100186	Zündkabel		1936300
4	100009	Piezozünder		1936100



Abb.	Bestell-Nr.	Beschreibung	Gerätetyp	Ver.-Nr.
1	102042	Thermoelement, 850mm	FP165	1916000
2	101086	Gashahn PEL22		1884100
3	110364	Knebel		1840900
4	110601	Symbol		184200, 862300

Hockerkocher (Elektro)



Abb.	Bestell-Nr.	Beschreibung	Gerätetyp	Vergleichs-Nr.
1	490106	5000W/400V	FP1E	779111
2	300104	Schalter		790700
3	110360	Knebel		18407000
4	110605	Symbol		1039111200

Tischherde (Gas)



Abb.	Bestell-Nr.	Beschreibung	Gerätetyp	Vergl.-Nr.
1	103020	Brennerdeckel, 80mm	FB-1GS/Neu, FB-2GS/Neu	1315612
2	104030	Brennertulpe		1315422
3	104033	Brennerpfeife		1315212
4	105051	Mischhülse		1314700
5	105052	Düsenstock		1306615

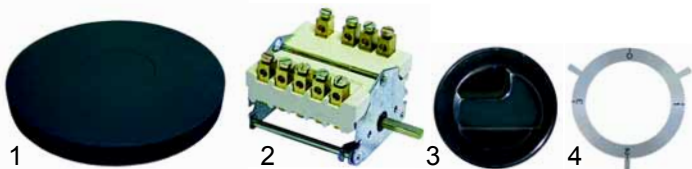

Abb.	Bestell-Nr.	Beschreibung	Gerätetyp	Vergl.-Nr.
1	103021	Brennerdeckel, 100mm	FB-1GS/Neu, FB-2GS/Neu	1315712
2	104031	Brennertulpe		1315512
3	103150	Brennerpfeife		1892500
4	105051	Mischhülse		1314700
5	105052	Düsenstock		1306615
6	103151	Reduzierung		1893300



Abb.	Bestell-Nr.	Beschreibung	Gerätetyp	Vergl.-Nr.
1	100095	Zündbrenner	FB-1GS/Neu, FB-2GS/Neu	1887700
2	100701	Zündkerze		1888300
3	100195	Zündkabel, 1200mm		1950324
4	100009	Piezozünder		1906100



Abb.	Bestell-Nr.	Beschreibung	Gerätetyp	Vergleichs-Nr.
1	102042	Thermoelement	FB-1GS/Neu, FB-2GS/Neu	1916000
2	101397	Gashahn PEL21		1888700, 1888800
3	110363	Knebel		1840800
4	110601	Symbol		1842000, 862300



Abb.	Bestell-Nr.	Beschreibung	Gerätetyp	Vergl.-Nr.
1	103020	Brennerdeckel, 80mm		1315600
2	104030	Brennertulpe		1315400
3	104033	Brennerpfeife	FB1GS (Alt), FB2GS (Alt)	1315200
4	105051	Mischhülse		1314700
5	105052	Düsenstock		1306600



Abb.	Bestell-Nr.	Beschreibung	Gerätetyp	Vergl.-Nr.
1	103021	Brennerdeckel, 100mm		1315700
2	104031	Brennertulpe		1315512
3	104034	Brennerpfeife	FB1GS (Alt), FB2GS (Alt)	1315300
4	105051	Mischhülse		1314700
5	105052	Düsenstock		1306600



Abb.	Bestell-Nr.	Beschreibung	Gerätetyp	Vergleichs-Nr.
1	100838	Zündleitung		1314600
2	100890	Halter	FB1GS (Alt), FB2GS (Alt)	1314915
3	100883	Zündbrenner		1314800
4	100885	Mischhülse		1324900



Abb.	Bestell-Nr.	Beschreibung	Gerätetyp	Vergl.-Nr.
1	102054	Thermoelement, 320mm		641400
2	102067	Mutter, M8x1		939300
3	101095	Gashahn, PEL21S		1700200
4	110363	Knebel	FB1GS (Alt), FB2GS (Alt)	1840800
5	110601	Symbol		1842000, 862300

Toaster



Abb.	Bestell-Nr.	Beschreibung	Gerätetyp	Vergleichs-Nr.
1	416572	1000W/230V		1037316500
2	359036	Signallampe		1037300810
3	380015	Energeregler	TSE-60M	426700, 1037035310
4	110408	Knebel		1036702200

Salamander



Abb.	Bestell-Nr.	Beschreibung	Gerätetyp	Vergleichs-Nr.
1	415140	2000W/230V	SME62M	1037316100 1037041200
2	415141	3000W/230V	SME63M	1037316200 1037042200
3	415142	3500W/230V	SME70M	1037316300 1037042300

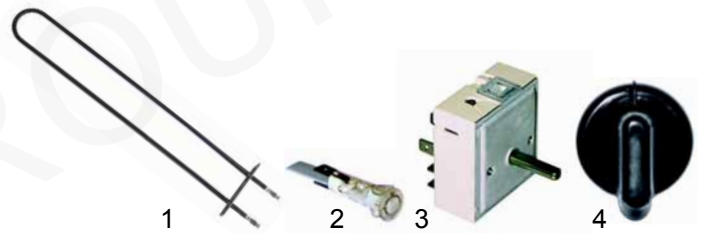

Abb.	Bestell-Nr.	Beschreibung	Gerätetyp	Vergleichs-Nr.
1	359036	Signallampe		1037300810
2	380015	Energeregler	SME62M SME63M SME70M	426700 1037035310
3	110408	Knebel		1036702200
4	380213	Schütz, 20A	SME70M	21453199

M

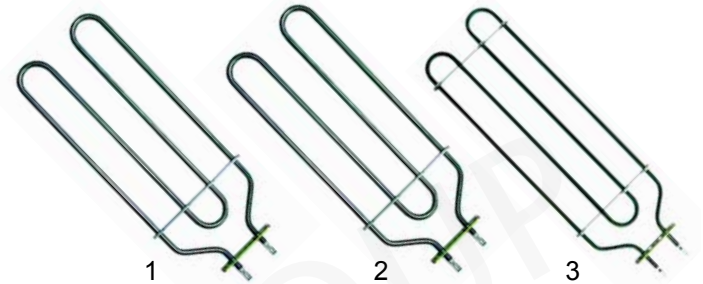
Pizzanachbackgeräte

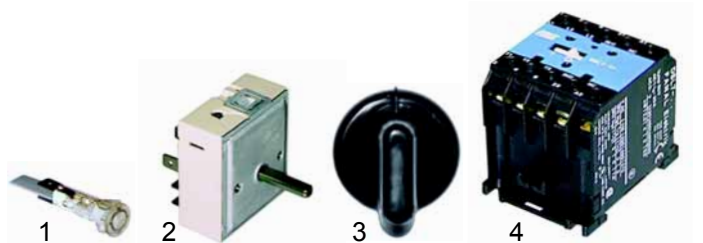

Abb.	Bestell-Nr.	Beschreibung	Gerätetyp	Vergleichs-Nr.
1	416573	1000W/230V	SPE60M	1037316400
2	n.m.l.	1000W/230V	SPW60M	1037340713
3	359036	Signallampe	SPE60M, SPN60M	1037300810



Abb.	Bestell-Nr.	Beschreibung	Gerätetyp	Ver.-Nr.
1	300021	Schalter		1230100
2	110360	Knebel		1840700
3	110604	Symbol	TP-13E/17E/21E,	1229000
4	375411	Thermostat	TP2-13E/17E/21E	1230200
5	110360	Knebel		1840700
6	110610	Symbol		1218500

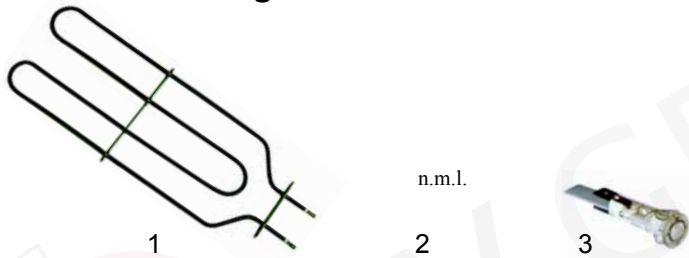

Abb.	Bestell-Nr.	Beschreibung	Gerätetyp	Vergl.-Nr.
1	375322	Thermostat, 1-polig	SPE60M	1037103500
2	350049	Zeitschalter	SPW60M	1037103400
3	110408	Knebel		1036702200

Friteusen



Abb.	Bestell-Nr.	Beschreibung	Gerätetyp	Vergl.-Nr.
1	416576	2500W/230V	FQE4	1037305600
2	416577	3500W/230V	FQE6/6+6	1037305700
3	375323	Sicherheitsthermostat		1031028000
4	359036	Signallampe (klar)	FQE4, FQE6, FQE6+6	1037300810
5	359140	Signallampe (gelb)		1037300910

Wärmestrahler



Abb.	Bestell-Nr.	Beschreibung	Gerätetyp	Vergleichs-Nr.
1	416665	1000W/230V		1037041613 1037041600
2	359270	Signallampe	RIE-40M, RIEP-40M	1037036300
3	380015	Energieregler		426710
4	110895	Knebel		1031019000



Abb.	Bestell-Nr.	Beschreibung	Gerätetyp	Vergleichs-Nr.
1	390046	Thermostat		1037035800
2	550060	Bügel	FQE4, FQE6, FQE6+6	921200
3	300091	Vorsatzschalter		1037035700
4	110896	Knebel		1031019800

Wärmeschränke

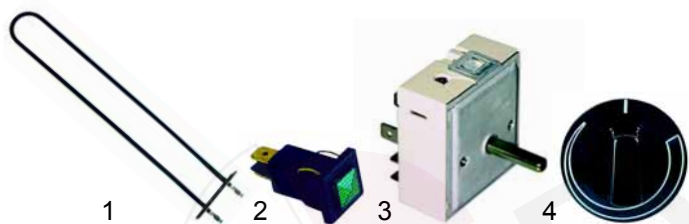

Abb.	Bestell-Nr.	Beschreibung	Gerätetyp	Ver.-Nr.
1	416575	770W/230V		1215400
2	601037	Querstromlüfter	TP-13E/17E/21E,	1215500
3	359159	Signallampe (gelb)	TP2-13E/17E/21E	912800
4	359160	Signallampe (grün)		1230300

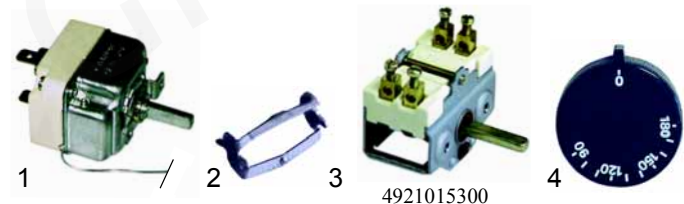

Abb.	Bestell-Nr.	Beschreibung	Gerätetyp	Vergleichs-Nr.
1	970334	Korb	FQE4	1031108200
2	970335	Korb	FQE6, FQE6+6	1031108700
3	540698	Auslaufhahn		1031401900

Notizen

Lined writing area for notes.

