



Wasch- und Nachspülsysteme

Seite 292

Diverses und Luftfallen

Seite 296

Ablauf- und Filtersysteme

Seite 298

Tür- und Haubenmechanik

Seite 300

Elektrokomponenten

Seite 301

Dosiertechnik

Seite 308

Heizkörper und Boiler

Seite 309

Pumpen und Ersatzteile

Seite 311

M Wasch- und Nachspülssysteme

Passend für Meiko



Abb.	Best.-Nr.	Beschreibung	Geräte-Typ	Vergl.-Nr.
1	501198	Wascharm, fest, oben		0620429
2	501001	Dichtung, 17 x 24 x 2		0217433
3	501172	Mutter, 3/8" x 5	FV28G,	0360211
4	501203	Draller	ECOstar 430F	0620436
5	501202	Düsenkappe		0620435
6	501211	T-Stück, 19mm-Schlauch		0621070
7	501206	Reduzierung		0620448



Abb.	Best.-Nr.	Beschreibung	Geräte-Typ	Vergl.-Nr.
1	501190	Steigrohr		0620294
2	501192	Wascharm		0620296
3	501193	Kappe, 1/2"	FR30G	0620297
4	501194	Kupplungsstück	FR40G	0620298
5	501191	Drosselkappe		0620295



Abb.	Best.-Nr.	Beschreibung	Geräte-Typ	Vergl.-Nr.
1	501216	Nachspülssystem, kpl.		8000023
2	501012	Nachspüldüse	FR30G	0472031
			FR40G	8000124
3	501176	Dichtung		0408003
4	501288	Mutter, 3/8"		8000024

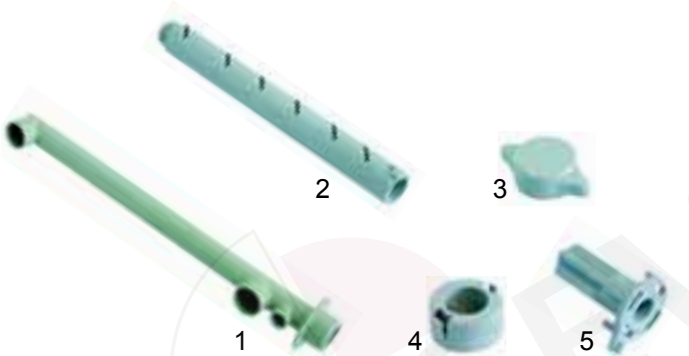

Abb.	Best.-Nr.	Beschreibung	Geräte-Typ	Vergl.-Nr.
1	501052	Nachspülarm	F25G oben	8000192
2	501051	Nachspülarm	F25G unten bis 31.12.91	8000191
3	501271	Nachspülarm	F28G, ECOstar 430F	8003886
4	501286	Nachspülarm	FV110G	8003968



Abb.	Best.-Nr.	Beschreibung	Geräte-Typ	Ver.-Nr.
1	501139	Nachspülarm, oben	FV40N bis 31.12.'91, DV40,	8000047
2	501138	Nachspülarm, unten	DV80 bis 30.4.'93, DV120B, DV80T, DV80TTA, DV120T, DV160	8000046
3	501291	Nachspülarm	FV120B oben, FV240B oben, FV130B unten, FV250B unten	8000096 9542573
4	501292	Nachspülarm	FV120B unten, FV240B unten, FV130B oben, FV250B oben	8000097 9542572

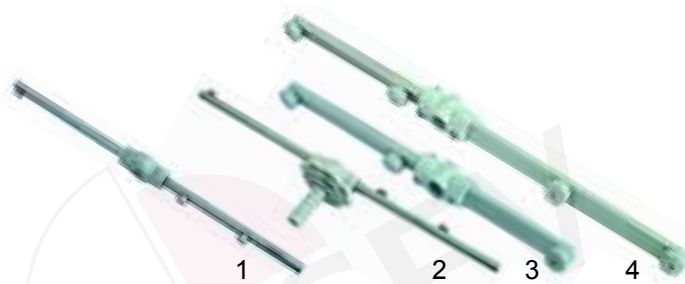

Abb.	Best.-Nr.	Beschreibung	Geräte-Typ	Vergl.-Nr.
1	501012	Nachspüldüse, CNS 0,6		0472031
1	501182	Nachspüldüse, CNS 0,5		0472032
2	501013	Nachspüldüsendraller		0620121
3	501014	Nachspüldüsenkappe		0620157

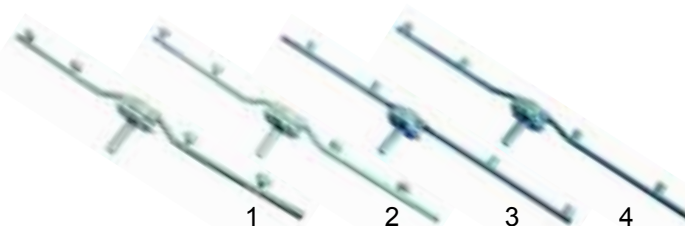

Abb.	Best.-Nr.	Beschreibung	Geräte-Typ	V.-Nr.
1	501272	Wasch- und Nachspülarm	FV25G ab 1.1.'92, FV28G, FV30G	8001813
2	501307	Wascharm, unten, kpl.	ECOstar 430F	8004683



Abb.	Best.-Nr.	Beschreibung	Geräte-Typ	V.-Nr.
1	501270	Wasch- und Nachspülarm	FV20N, FV20T, FV40N, FV40T, FV40TFA, FV60E, FV70T, FV110G, DV40 ab 1.1.'92, DV40N, DV40T, DV40TFA	8001814
2	501293	Wascharm, unten, kpl.	FV25G bis 31.12.'91	8000187



Abb.	Best.-Nr.	Beschreibung	Geräte-Typ	Vergl.-Nr.
1	501294	Wascharm, oben	FV130B, FV250B	8000677 9525862
2	501295	Wascharm, unten	FV250B	8000678 9525861
3	501141	Wascharm, oben	DV80, DV80T, DV80TFA, DV120B ab 1.1.'92, DV120T, DV160	8000147
4	501140	Wascharm, unten	DV80, DV80T, DV80TFA, DV120B ab 1.1.'92, DV120T, DV160	8000146

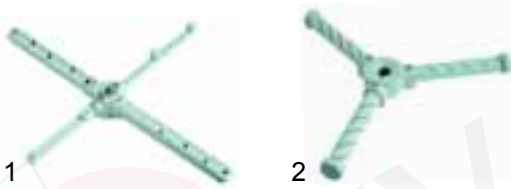

Abb.	Best.-Nr.	Beschreibung	Geräte-Typ	V.-Nr.
1	501228	Dreharmnabe, oben		8000045
1	501227	Dreharmnabe, unten		8000044
2	501225	Waschrohr	FV40N bis 31.12.'91, DV40 bis 31.12.'91	8000042
3	501226	Waschrohr		8000043
4	501015	Kappe		0620163

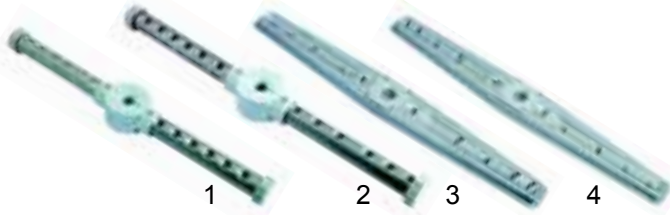

Abb.	Best.-Nr.	Beschreibung	Geräte-Typ	Vergl.-Nr.
1	501104	Dreharmnabe, oben		8000094
1	501045	Dreharmnabe, unten		8000093
2	501102	Waschrohr, oben	FV120B, FV240B	8000091
3	501103	Waschrohr, oben	FV120B, FV240B	8000092
4	501099	Waschrohr, unten		8000088
5	501100	Waschrohr, unten		8000089
6	501101	Waschrohr, unten		8000090
7	501015	Kappe		0620163

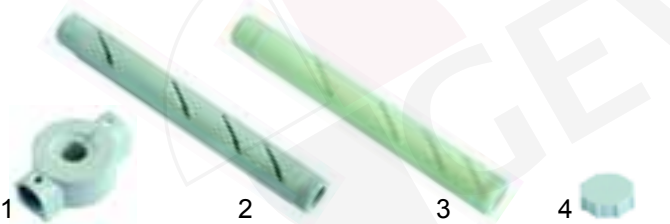

Abb.	Best.-Nr.	Beschreibung	Geräte-Typ	V.-Nr.
1	501228	Dreharmnabe, oben/unten		8000045
1	501227	Dreharmnabe, unten		8000044
2	501230	Waschrohr	DV80 bis 31.12.'91, DV120 bis 31.12.'91	8000052
3	501231	Waschrohr		8000053
4	501015	Kappe		0620163

Einzelteile

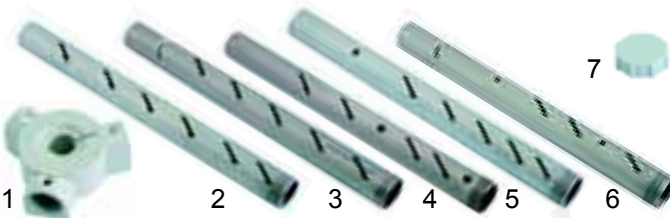

Abb.	Best.-Nr.	Beschreibung	Geräte-Typ	Vergl.-Nr.
1	501249	Dreharmachse		8000231
2	501019	Dreharmachse		0620286
3	501016	Scheibenhälfte		0620211
4	501044	Mutter, Linksgewinde		8000049
4	501095	Mutter, Rechtsgewinde		8000048

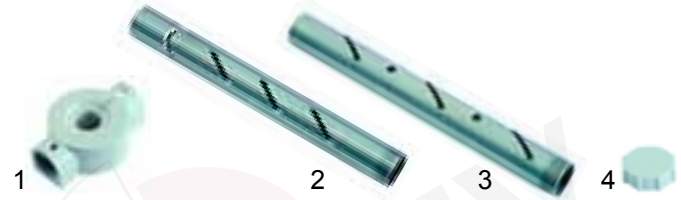

Abb.	Best.-Nr.	Beschreibung	Geräte-Typ	Vergl.-Nr.
1	501032	Dreharmnabe		0620394
2	501025	Dreharmnabe		0620380
3	501197	Nachspülrohr, 110mm		0620391
4	501031	Nachspülrohr, 150mm		0620390
5	501030	Nachspülrohr, 210mm		0620389



Abb.	Best.-Nr.	Beschreibung	Vergl.-Nr.
1	501196	Waschrohr, 170mm, innen gerade	0620388
2	501195	Waschrohr, 170mm, innen schräg	0620387
3	501029	Waschrohr, 230mm, innen gerade	0620386
4	501028	Waschrohr, 230mm, innen schräg	0620385
5	501004	Rändelschraube	0310010
6	501027	Schraubkappe	0620384

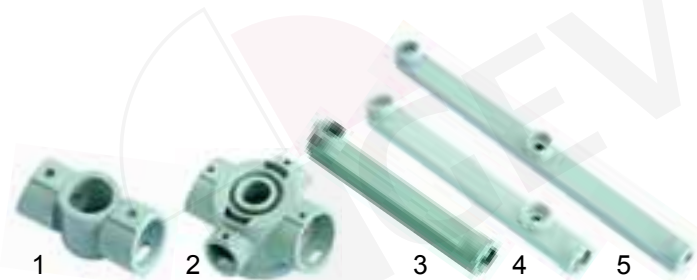

Abb.	Best.-Nr.	Beschreibung	Geräte-Typ	Vergl.-Nr.
1	501045	Dreharmnabe	FV25G	8000093
2	501056	Waschrohrsatz (3-teilig)		8000321

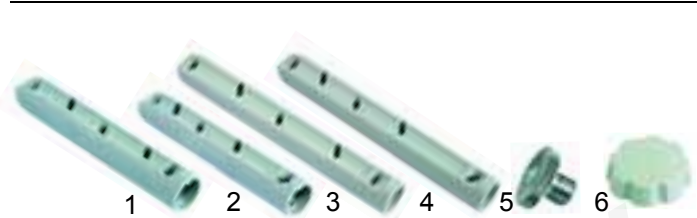

Abb.	Best.-Nr.	Beschreibung	Geräte-Typ	Vergl.-Nr.
1	501129	Dreharmnabe, oben		0620282
1	501128	Dreharmnabe, unten		0620281
2	501090	Dreharmnabe, oben		0620393 9525703
2	501089	Dreharmnabe, unten	FV130B, FV250B	0620392 9525702
3	501083	Kappe		0620292

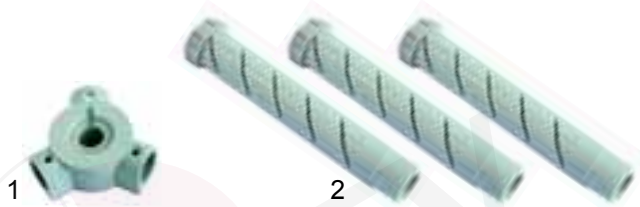

Abb.	Best.-Nr.	Beschreibung	Geräte-Typ	V.-Nr.
1	501046	Nachspülarmhalter, oben		8000181
2	501043	Gummistütze		0650001
3	501175	Teflonscheibe	FV25G	0403302
4	501047	Rändelschraube, kpl. mit Teflonscheibe und Sicherungsring		8000182



Abb.	Best.-Nr.	Beschreibung	Geräte-Typ	V.-Nr.
1	501048	Nachspülrohr		8000188
2	501049	Zentrierstern	FV25G bis	8000189
3	501050	Dreharmkappe	31.12.'91	8000190
4	501007	O-Ring		0401030

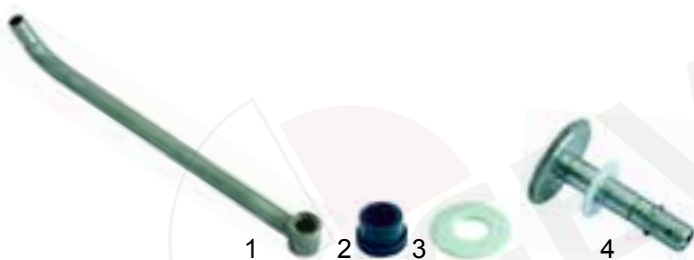

Abb.	Best.-Nr.	Beschreibung	Geräte-Typ	V.-Nr.
1	501251	Zentrierstern		0620382 8001737
2	501050	Dreharmlager	FV25G ab 1.1.'92	8000190
3	501007	O-Ring		0401030

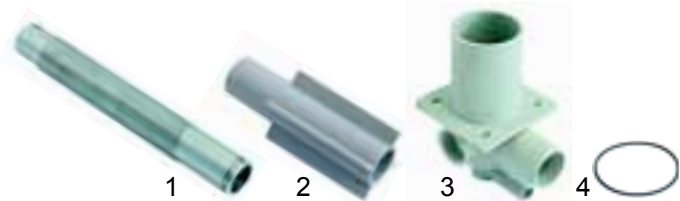

Abb.	Best.-Nr.	Beschreibung	Geräte-Typ	Vergl.-Nr.
1	501017	Nachspülarmhalter		0620235
2	501176	Dichtung, 24 x 17 x 1,5		0408003
3	501153	Dreharmlager	FV28G oben, ECOstar 430F	8004008
4	501004	Rändelschraube		0310010



Abb.	Best.-Nr.	Beschreibung	Geräte-Typ	Vergl.-Nr.
1	501256	Drosselscheibe		8004179
2	501204	Adapter		0620446
3	501026	Zentrierstern, 180mm	FV28G unten	0620381
4	501201	Dreharmlager		0620432
5	501007	O-Ring		0401030



Abb.	Best.-Nr.	Beschreibung	Geräte-Typ	Ver.-Nr.
1	501134	Zentrierstern, oben	FV30GS, FV20N, FV20T, FV40T,	0620383 8001738
2	501131	Dreharmlager, unten	FV40N ab 1.1.'92, FV40TFA, FV60E,	0620288 8000968
3	501007	O-Ring	FV70T, ECOstar 530F	0401030

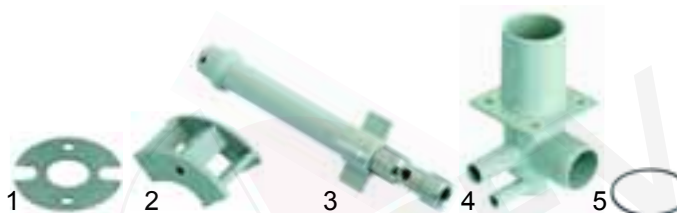

Abb.	Best.-Nr.	Beschreibung	Geräte-Typ	Vergl.-Nr.
1	501256	Drosselscheibe	ECOstar 430F	8004179
2	501204	Adapter		0620446
3	501308	Zentrierstern		8004195
4	501201	Dreharmlager		0620432
5	501007	O-Ring		0401030



Abb.	B.-Nr.	Beschreibung	Geräte-Typ	V.-Nr.
1	501026	Zentrierstern, unten	FV30GS, FV20N, FV20T, FV40N ab 1.1.'92, FV40T, FV40TFA, FV60E,	0620381 8001736
2	501130	Dreharmlager, unten	FV70E, FV110G, ECOstar 580F	0620285
3	501007	O-Ring		0101030

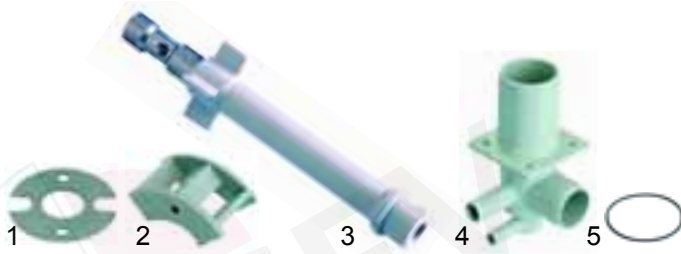

Abb.	Best.-Nr.	Beschreibung	Geräte-Typ	Vergl.-Nr.
1	501224	Nachspülrohr, oben	FV40N bis 31.12.'91	8000041
2	501221	Zentrierstern, oben		8000088
3	501131	Dreharmlager		8000037 0620288



Abb.	Best.-Nr.	Beschreibung	Geräte-Typ	Vergl.-Nr.
1	501223	Nachspülrohr, unten	FV40N bis 31.12.'91	8000040
2	501222	Zentrierstern, unten		8000039
3	501297	Dreharmlager, unten		8000036

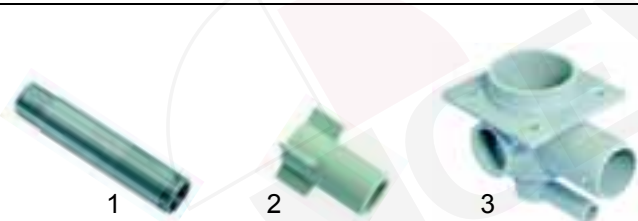

Abb.	Best.-Nr.	Beschreibung	Geräte-Typ	Vergl.-Nr.
1	501017	Nachspülarmhalter		0620235
2	501176	Dichtung, 24 x 17,15	FV110G	0408003
3	501298	Dreharmlager		8003957
4	501004	Rändelschraube		0310010

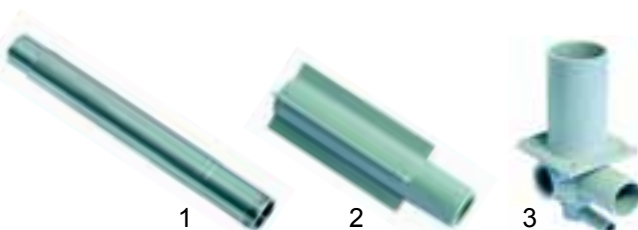

Abb.	Best.-Nr.	Beschreibung	Geräte-Typ	Vergl.-Nr.
1	501110	Nachspülrohr, oben	FV130B, FV250B	8000680
2	501111	Nachspülrohr, unten		8000681
3	501001	Dichtung		0217433
4	501074	Teflonscheibe		0403303
5	501017	Winkelanschluss		0620235



Abb.	Best.-Nr.	Beschreibung	Geräte-Typ	Vergl.-Nr.
1	501098	Nachspülrohr, oben	FV120B, FV240B	8000087
2	501097	Zentrierstern, oben		8000086
3	501096	Dreharmlager, oben		8000085
4	501007	O-Ring		0401030



Abb.	Best.-Nr.	Beschreibung	Geräte-Typ	Vergl.-Nr.	
1	501235	Nachspülrohr, oben	DV40 bis 1.12.'91	8000067	
1	501234	Nachspülrohr, unten		8000066	
2	501253	Nachspülrohr		DV40 ab 1.1.'92	8002125
3	501127	Zentrierring			0620264
4	501001	Dichtung		DV40	0217433
5	501074	Teflonscheibe			0403303
6	501017	Winkelanschluss	0620235		

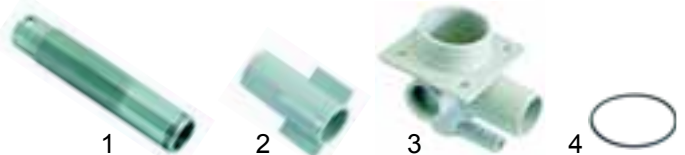

Abb.	Best.-Nr.	Beschreibung	Geräte-Typ	Vergl.-Nr.
1	501062	Zentrierstern, oben	DV40N, DV40T, DV40TFA	0620505 8004475
2	501299	Mutter, 1/2"		8660464
3	501061	Distanzscheibe		8004468
4	501006	O-Ring		0401016



Abb.	Best.-Nr.	Beschreibung	Geräte-Typ	Vergl.-Nr.
1	501026	Zentrierstern, unten	DV40N, DV40T,	0620381
2	501033	Dreharmlager, unten	DV40TFA	0620443
3	501007	O-Ring		0401030

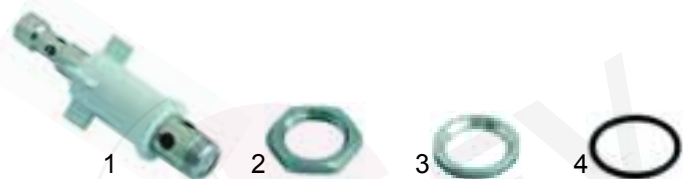

Abb.	Best.-Nr.	Beschreibung	Geräte-Typ	Vergl.-Nr.
1	501235	Nachspülrohr, oben		8000067
1	501234	Nachspülrohr, unten	DV80 bis	8000066
2	501127	Zentrierring	30.4.'93,	0620264
3	501244	Reduzierung	DV120 bis	8000077
4	501162	Winkelanschluss	31.12.'91	0206022

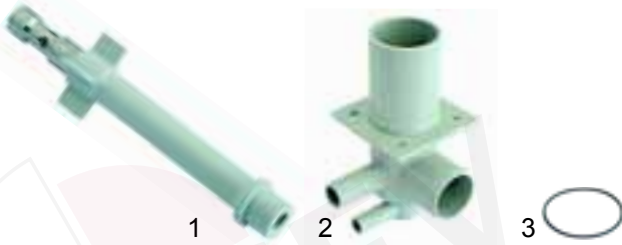

Abb.	Best.-Nr.	Beschreibung	Geräte-Typ	Vergl.-Nr.
1	501248	Nachspülrohr, oben		8000173
1	501247	Nachspülrohr, unten		8000172
2	501127	Zentrierring	DV80 ab 1.5.'93,	0620264
3	501001	Dichtung	DV120 ab	0217433
4	501074	Tefonscheibe	1.1.'92,	0403303
5	501017	Winkelanschluss	DV160	0620235



Abb.	Best.-Nr.	Beschreibung	Geräte-Typ	Vergl.-Nr.
1	501154	Zentrierstern, oben	DV80T, DV80TFA, DV120T	8004469 0620506
2	501299	Mutter, 1/2"		8660464
3	501061	Distanzscheibe		8004468
4	501006	O-Ring		0401016



Abb.	Best.-Nr.	Beschreibung	Geräte-Typ	Vergl.-Nr.
1	501142	Nachspülrohr, unten		8000174
2	501126	Zentrierstern, unten	DV80T,	0620233
3	501033	Dreharmlager, unten	DV80TFA, DV120T	0620443
4	501007	O-Ring		0401030

Diverses

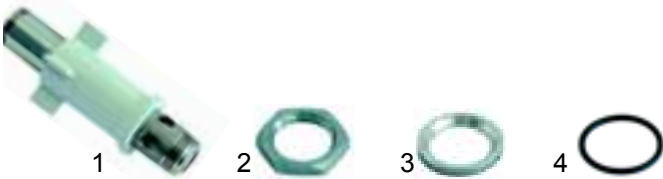

Abb.	Best.-Nr.	Beschreibung	Geräte-Typ	Vergl.-Nr.
1	501017	Winkelanschluss		0620235
2	501082	Winkelanschluss		0620287
3	501156	Reduzierung		8004877

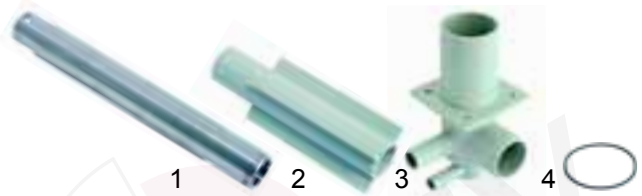

Abb.	Bestell.-Nr.	Beschreibung	Vergleichs-Nr.
1	501021	Schlauchanschluss, 1-fach	0620342
2	501024	Schlauchanschluss, 2-fach	0620373
3	501022	Schlauchanschluss, 2-fach	0620343



Abb.	Bestell.-Nr.	Beschreibung	Vergleichs-Nr.
1	501210	Y-Stück, 10mm	0621040
2	501040	Y-Stück, 13mm	0621036
3	501039	T-Stück, 13mm	0621035



Abb.	Bestell.-Nr.	Beschreibung	Vergleichs-Nr.
1	501186	Winkelanschluss, 19mm	0620129
2	501211	Y-Stück, 19mm	
3	501113	Boileranschluss	8000978



Abb.	Bestell-Nr.	Beschreibung	Vergleichs-Nr.
1	501212	Winkelanschluss, 13mm	0621072
2	501162	Winkelanschluss,	0206022
3	501244	Reduzierung	8000077



Abb.	Bestell-Nr.	Beschreibung	Vergleichs-Nr.
1	501005	Schlauchanschluss, 13mm	0360202
2	501010	Dichtung, 25 x 14 x 1,5	0408008
3	501121	Schlauchanschluss, 19mm, 1/2"	8400250
4	501075	Dichtung, 30 x 21 x 1,5	0408006



Abb.	Bestell-Nr.	Beschreibung	Vergleichs-Nr.
1	501020	Rücksaugverhinderer, 13mm	0620334
2	501088	Rücksaugverhinderer, 19mm	0620349



Abb.	Bestell-Nr.	Beschreibung	Geräte-Typ	Vergl.-Nr.
1	501135	Freier Auslauf	FV40TFA, FV70TD, DV40TFA, DV80TFA	0620460
2	501137	Dichtung		0650076



Abb.	Bestell-Nr.	Beschreibung	Geräte-Typ	Ver.-Nr.
1	530000	Enthärter, 4 Kolonnen		0270064
2	501170	Enthärter, 8 Kolonnen	DV40	0270063
3	530006	Enthärter, 8 Kolonnen	FV40T	0270062



Abb.	Bestell-Nr.	Beschreibung	Geräte-Typ	Ver.-Nr.
1	510929	Salzbehälter		0270106
2	524177	Deckel		9532505
3	510898	Dichtung		-
4	524178	Mutter		-
5	510883	Dichtung		9500825

Klarspülmittelbehälter



Abb.	Bestell-Nr.	Beschreibung	Geräte-Typ	Ver.-Nr.
1	501002	N6-Behälter		0260028
2	501059	Behälter, blau		8003830
2	501257	Behälter, klar		8004424



Abb.	Bestell-Nr.	Beschreibung	Geräte-Typ	Ver.-Nr.
1	501067	Dosierbehälter		0260028
2	371122	Sieb		0113098
3	501081	Schlauchanschluss		0620245
4	501303	Mutter, M10		0335019



Abb.	Bestell-Nr.	Beschreibung	Geräte-Typ	Ver.-Nr.
1	501169	Deckel für Behälter		0260042
2	501003	Behälterfilter		8001801 0260090
3	501287	Winkelanschluss		0260049

Luftfallen



Abb.	Bestell-Nr.	Beschreibung	Geräte-Typ	Vergl.-Nr.
1	501018	Luftfalle	Universal	0620244
2	501043	Gummistutzen		0650001

Ablauf- und Filtersysteme



Abb.	Bestell-Nr.	Beschreibung	Geräte-Typ	Vergl.-Nr.
1	501054	Ansaugstutzen	FV25G	8000194 8001008
2	501254	Ansaugstutzen	FV30GS	8002176
3	501218	Ansaugstutzen	FV40N, FV60E	8000032



Abb.	Bestell-Nr.	Beschreibung	Geräte-Typ	Vergl.-Nr.
1	501215	Ansaugstutzen	FR30G, FR40H	8000021
2	501232	Ansaugstutzen	OR50H	8000056
3	501233	Ansaugstutzen	DV40	8000065



Abb.	Bestell-Nr.	Beschreibung	Geräte-Typ	Vergl.-Nr.
1	501107	Verstärkungsring	FV130	8000471
2	501105	Ansaugstutzen	FV120B, FV240B	8000095
3	501112	Ansaugstutzen	FV130B	8000855



Pos.	Bestell-Nr.	Beschreibung	Geräte-Typ	Vergl.-Nr.
1	501243	Ansaugstutzen	DV80	8000076



Pos.	Bestell-Nr.	Beschreibung	Geräte-Typ	Vergl.-Nr.
1	501245	Ansaugstutzen	DV120B	8000082



Abb.	Best.-Nr.	Beschreibung	Geräte-Typ	Vergl.-Nr.
1	501207	Pumpensieb, kurz	FV25G, FR30G, FV30GS, FR40G,	0620500
2	501053	Pumpensieb, kurz, mit Spannring	FV40N, FV60E, DV120B, DV240B, DV40, DV80	8000193 8003298



Abb.	Best.-Nr.	Beschreibung	Geräte-Typ	Vergl.-Nr.
1	501091	Pumpensieb, lang	FV120B, FV240B,	0620501
2	501124	Pumpensieb, lang, mit Spannring	FV130B, DV160	8680031

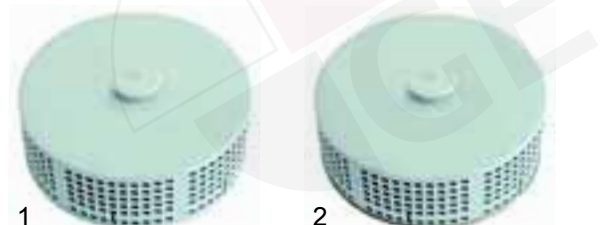

Abb.	Best.-Nr.	Beschreibung	Geräte-Typ	Vergl.-Nr.
1	501079	Spannring	Universal	0431051
2	501094	Gegenblech		8000022
3	501008	O-Ring		0401045

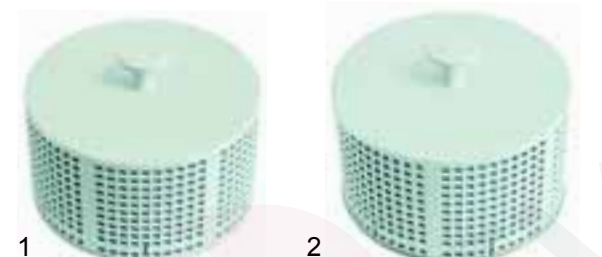

Abb.	Bestell-Nr.	Beschreibung	Vergleichs-Nr.
1	501300	Standrohrventil, kpl., 1 1/2"	8002887
2	501165	Standrohrventil, kpl., 2"	0237028



Abb.	Bestell-Nr.	Beschreibung	Vergleichs-Nr.
1	522000	Ablaufventil	0620219
2	501320	Gummidichtung	0408214
3	510406	Dichtung	0408020
4	501321	Mutter, 1 1/2"	0212006



Abb.	Bestell-Nr.	Beschreibung	Geräte-Typ	Vergl.-Nr.
1	501038	Standrohr, 85mm	FV25G, FR30G, FR40G	0620600
2	501208	Standrohr, 105mm	FV30GS, FV40N, FV60E	0620601
3	501092	Standrohr, 115mm	OR50H	0620602
4	501209	Standrohr, 125mm	DV40, DV80, DV120B, DV160, DV240B	0620603
5	501122	Standrohr, 185mm	FV130B	8650009



Abb.	Best.-Nr.	Beschreibung	Geräte-Typ	V.-Nr.
1	501065	Standrohrventil-Oberteil, 2"	FV250B	0237003
2	501066	Dichtung, 2"		0237009
3	501301	Mutter		0237008
4	501123	Standrohr		8650064



Abb.	Best.-Nr.	Beschreibung	Geräte-Typ	Vergl.-Nr.
1	501200	Sieb	FV28G, ECOstar 430F	0620431
2	501173	O-Ring		0401070
3	501199	Pumpensumpf		0620430



Abb.	Bestell-Nr.	Beschreibung	Vergleichs-Nr.
1	501023	Sieb	0620346
2	501009	O-Ring	0401061



Abb.	Best.-Nr.	Beschreibung	Geräte-Typ	V.-Nr.
1	501155	Pumpensumpf, freier Auslauf	FV20N, FV20T, FV40T, FV40TFA, FV70T, FV70TD,	8004844
2	501149	Pumpensumpf	FV110G, ECOstar 530F	8003639



Abb.	Best.-Nr.	Beschreibung	Geräte-Typ	V.-Nr.
1	501150	Pumpensumpf	DV40, DV80	8003669
2	501151	Pumpensumpf	DV120B	8003787



Abb.	Best.-Nr.	Beschreibung	Geräte-Typ	V.-Nr.
1	501063	Pumpensumpf mit Standrohr	DV40N, DV40T, DV40TFA, DV80T, DV80TFA	8004720
2	501258	Pumpensumpf, kpl. mit Standrohr	DV120T	8004721

Überlaufrohre (Pumpensumpf)

Abb.	Best.-Nr.	Beschreibung	Geräte-Typ	Vergl.-Nr.
1	501132	Standrohr, 140mm	FV20N, FV20T, FV40T, FV40TFA, FV70T, FV70TD, FV110G, ECOstar 430F, ECOstar 530F	0620347
2	501133	Standrohr, 175mm	DV40, DV80, DV120B	0620348
3	501205	Standrohr, 214mm	DV40N, DV120N	0620447 8070117
4	501037	Standrohr, 255mm	DV40T, DV40TFA, DV80T, DV80TFA, DV120T	0620457

Saugstutzen/Laugenpumpe

Abb.	Best.-Nr.	Beschreibung	Geräte-Typ	Vergl.-Nr.
1	501146	Saugstutzen	OR-50H	8002263
2	501148	Saugstutzen	FV25G, FV30GS, FR30G, FR400G	8002534
3	501058	Saugstutzen	DV40, DV80, DV120B	8003301

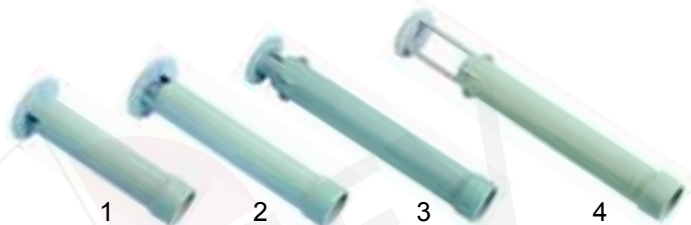

Abb.	Best.-Nr.	Beschreibung	Geräte-Typ	V.-Nr.
1	501147	Saugstutzen	FV40N, FV60E	8002264
2	501157	Saugstutzen	FV20TFA, FV40TFA, FV70TFA	8004985
3	501152	Saugstutzen	FV20T, FV40T, FV70T	8003831

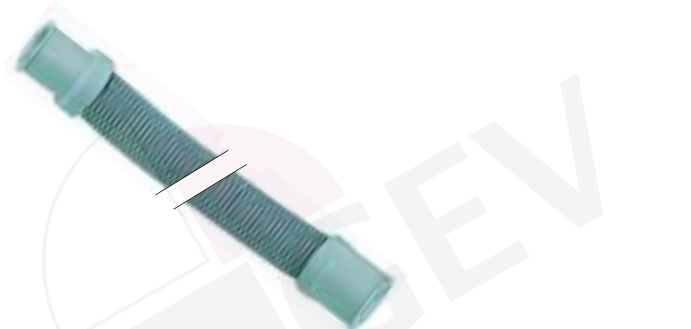

Pos.	Best.-Nr.	Beschreibung	Vergl.-Nr.
1	501136	Ablaufschlauch, Laugenpumpe, 2,5m	0640037



Abb.	Bestell-Nr.	Beschreibung	Vergl.-Nr.
1	501041	PVC-Schlauch, 35 x 5	0630209
2	501042	DIN904-Schlauch, 38 x 4	0640007



Abb.	Bestell-Nr.	Beschreibung	VPE	Vergl.-Nr.
1	501068	CV-Verbinder	1 Stck.	0296002
2	520111	Schlauchschnelle, 10 - 16	10 Stck.	0233036
2	520112	Schlauchschnelle, 12 - 22	10 Stck.	0233043
2	520116	Schlauchschnelle, 32 - 50	10 Stck.	0233046
2	520117	Schlauchschnelle, 40 - 60	5 Stck.	0233041
2	520113	Schlauchschnelle, 16 - 25	10 Stck.	0233037
2	520115	Schlauchschnelle, 25 - 40	10 Stck.	0233039
2	520118	Schlauchschnelle, 50 - 70	5 Stck.	0233047
3	520065	Schlauchschnelle, N10	5 Stck.	0233055

Türmechanik

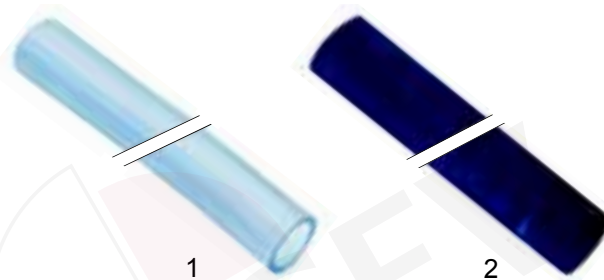
Abb.	Bestell-Nr.	Beschreibung	Geräte-Typ	Ver.-Nr.
1	501322	Türlager, rechts		8003600
2	501323	Türlager, links		8003681
3	501324	Rolle, kurz	FV20N, FV40T, FV40TFA, FV70T, FV70TD, FV110G, ECOstar 530G	8003677 0621084
4	501325	Rolle, lang		8003675 0621085
5	501326	Zugfeder		0430025



Abb.	Bestell-Nr.	Beschreibung	Geräte-Typ	Ver.-Nr.
1	501327	Türlager, rechts	FV28G, ECOstar 430G	8004426
2	501328	Türlager, links		8003985
3	501329	Rolle		0620398
4	501330	Seilhaken		0435150
5	501331	Zugseil		0435151
6	501326	Zugfeder		0430025

Haubenmechanik



Abb.	Bestell-Nr.	Beschreibung	Geräte-Typ	Ver.-Nr.
1	501250	Haubengestänge	DV40, DV80, DV120B ab 1.1.'92	8000716
2	501237	Haubengestänge	DV40, DV80 bis 31.12.'91	8000070



Abb.	Bestell-Nr.	Beschreibung	Geräte-Typ	Ver.-Nr.
1	501187	Lagerschale		0620146
2	501238	Bolzen	DV40, DV80,	8000071
3	501188	Laufrolle	DV120B	0620148
4	501055	Schraube		8000230

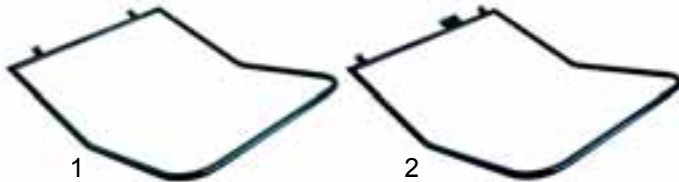

Abb.	Bestell-Nr.	Beschreibung	Geräte-Typ	Ver.-Nr.
1	501239	Zugstange		8000072
2	501240	Spannschraube	DV40, DV80,	8000073
3	501057	Feder	DV120B	0430006 8001613



Abb.	Bestell-Nr.	Beschreibung	Geräte-Typ	Ver.-Nr.
1	501035	Lager		0620449
2	501034	Gleitlager	DV40N, DV40T, DV40TFA, DV80T,	0620445
3	501036	Laufrolle	DV80TFA	0620451
4	501055	Schraube		8000230

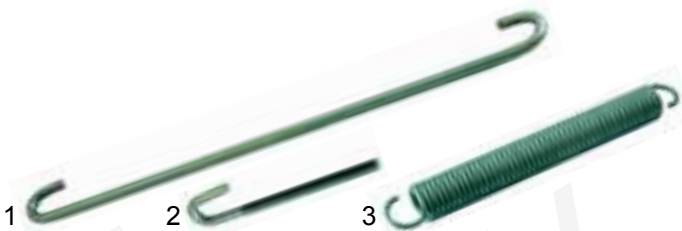

Abb.	Bestell-Nr.	Beschreibung	Geräte-Typ	Ver.-Nr.
1	501060	Spannschraube	DV40N, DV40T,	8004425
2	501057	Feder	DV40TFA, DV80T, DV80TFA	8001613



Abb.	Bestell-Nr.	Beschreibung	Geräte-Typ	Ver.-Nr.
1	501078	Stossdämpfer, 75N	FV130B	0431041
2	501077	Stossdämpfer, 140N/150N	FV250B	0431040

Elektrokomponenten



Abb.	Bestell-Nr.	Beschreibung	Geräte-Typ	Ver.-Nr.
1	400195	Frontfolie	FV20V, FV20T, FV25G, FR30G,	0467221
2	400210	Diodenplatine	FV30GS, FV40N,	0124186
3	400220	Steuerplatine	FV40T, DV40, DV40N, DV80	0124187



Pos.	Bestell-Nr.	Beschreibung	Geräte-Typ	Ver.-Nr.
1	400243	Rechner (3), P1/5	FV25G, FR30G,	0124205
2	400723	Rechner (3), P30/5	FR30GS, DV40, DV80	0124231
3	400722	Rechner (3), P24/5		0124225



Abb.	Bestell-Nr.	Beschreibung	Geräte-Typ	Ver.-Nr.
1	400196	Frontfolie	FV40T, FV60E,	0467210
2	400211	Diodenplatine	FV70T, DV40T,	0124196
3	400221	Steuerplatine	DV80T, DV120B, DV120T	0124190 0124191



Abb.	Bestell-Nr.	Beschreibung	Geräte-Typ	Ver.-Nr.
1	400842	Frontfolie	ECOstar 430F	9503064
2	400843	Frontfolie	ECOstar 530F	9503065



Pos.	Bestell-Nr.	Beschreibung	Geräte-Typ	Ver.-Nr.
1	400720	Rechner (4), P6/5	FV40T, FV60E, DV120B	0124201
2	400829	Rechner (4), P26/5	FV70T	0124227
3	400838	Rechner (4), P58/5	DV40T	0124223
4	400835	Rechner (4), P39/5	DV80T	0124239
5	400839	Rechner (4), P49/5	DV120T	0124222



Abb.	Bestell-Nr.	Beschreibung	Geräte-Typ	Ver.-Nr.
1	400220	Leistungsplatine	ECOstar 430F, ECOstar 530F, FV2S	0124187
2	400845	Flachbandkabel	ECOstar 430F,	9503172
2	400846	Flachbandkabel	ECOstar 530F	9503170
3	400847	Rechner, P64/5		9505865
3	400848	Rechner, P65/5		9505866



Abb.	Bestell-Nr.	Beschreibung	Geräte-Typ	Ver.-Nr.
1	400820	Frontfolie	FV28G	0467207
2	400819	Frontfolie, VE/TE		0467208

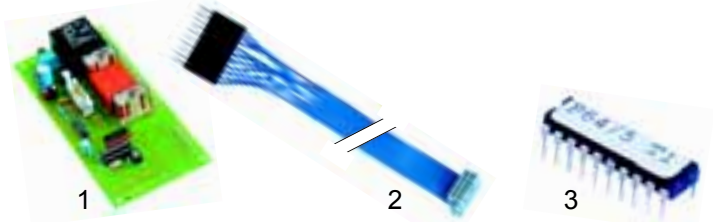

Abb.	Bestell-Nr.	Beschreibung	Geräte-Typ	Ver.-Nr.
1	400811	Steuerplatine		0124092
2	400815	Leistungsplatine	FV28G	0124091
3	400813	Leistungsplatine		0124093
4	400959	Steuerplatine (Dosierg.)		9500250
5	400960	Steuerplatine (Dosierg.)		9500251



Abb.	Bestell-Nr.	Beschreibung	Geräte-Typ	Ver.-Nr.
1	400197	Folientastatur	FV40TFA,	0467249
2	400812	Bedienplatine	FV70TD, DV40TFA, DV80TFA	0124120

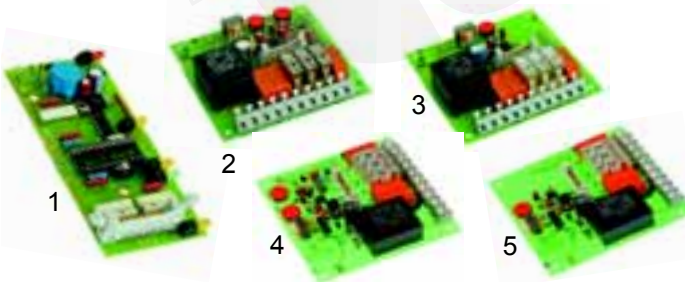

Abb.	Bestell-Nr.	Beschreibung	Geräte-Typ	Ver.-Nr.
1	400821	Steuerplatine		0124122 0124121 9519719
2	400822	Rechner, TF	FV40TFA,	0124124
2	400823	Rechner, Standard	FV70TD, DV40TFA,	0124351
2	400824	Rechner, Desinfektion	DV80TFA	0124352
3	400825	E-Prom unprogrammiert		0124123 9534803



Abb.	Bestell-Nr.	Beschreibung	Geräte-Typ	Ver.-Nr.
1	400721	Sanftanlauf	FV28G	0124217
2	400840	Rechner (5), P1/9		0124246

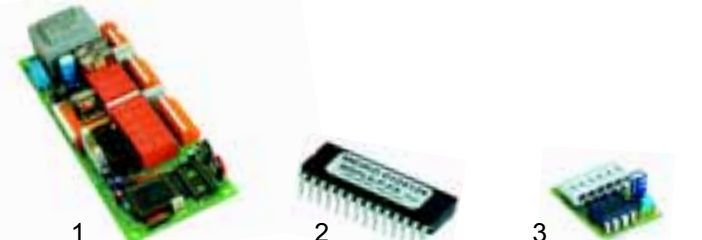

Abb.	Bestell-Nr.	Beschreibung	Geräte-Typ	Ver.-Nr.
1	400197	Folientastatur	FV130B, FV250B,	0467249
2	400211	Diodenplatine	FV110G	0124196

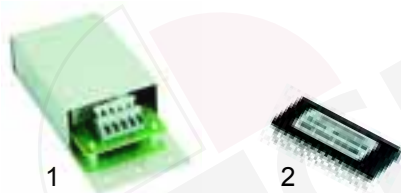

Abb.	Bestell-Nr.	Beschreibung	Geräte-Typ	Ver.-Nr.
1	400221	Steuerplatine		0124190 0124191
2	400826	Rechner/Spül, P8/5		0124203
2	400827	Rechner/Spül, P12/5		0124210
2	400828	Rechner/Spül, P14/5		0124214
2	400829	Rechner/Spül, P26/5		0124227
2	400830	Rechner/Spül, P27/5		0124228
2	400831	Rechner/Spül, P28/5	FV130B, FV250B,	0124229
2	400832	Rechner/Spül, P29/5	FV110G	0124230
2	400833	Rechner/Spül, P37/5		0124243
2	400834	Rechner/Spül, P38/5		0124236
2	400835	Rechner/Spül, P39/5		0124239
2	400836	Rechner/Spül, P41/5		0124237
2	400837	Rechner/Spül, P46/5		0124245
2	400838	Rechner/Spül, P58/5		0124223



Pos.	Bestell-Nr.	Beschreibung	Vergleichs.-Nr.
1	400816	Flachbandkabel, 0,8m, 10-polig	0180502
2	400817	Flachbandkabel, 0,8m, 14-polig	0180507
3	400841	Flachbandkabel, 0,8m, 20-polig	0180503
4	400818	Flachbandkabel, 1,8m, 20-polig	0180558

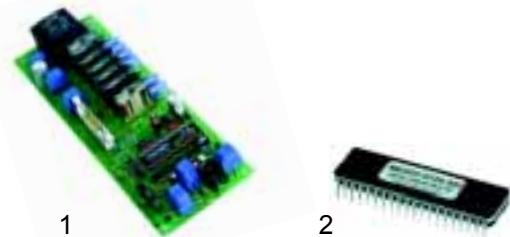
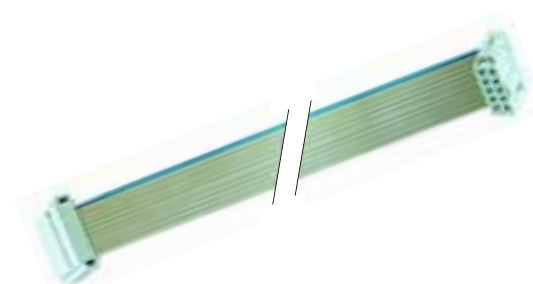

Abb.	Best.-Nr.	Beschreibung	Geräte-Typ	V.-Nr.
1	379152	Temperaturfühler, 1/4"	FV40TFA, FV70TD, DV40TFA, DV80TFA	0180682
2	379153	Temperaturfühler	FV28GFH, FV40T	9500236



Abb.	Best.-Nr.	Beschreibung	Geräte-Typ	V.-Nr.
1	501177	Dichtung, 19 x 13		0408227
2	501318	Mutter/CNS, 1/4"		0212012

Tastaturfolien



Abb.	Bestell-Nr.	Beschreibung	Geräte-Typ	Ver.-Nr.
1	400820	GI	F28G	0467207
2	400819	GI mit Vollentsalzung		0467208



Abb.	Bestell-Nr.	Beschreibung	Geräte-Typ	Ver.-Nr.
1	400842	Tastaturfolie	ECOstar 430F	9503064
2	400843	Tastaturfolie	ECOstar 530F	9503065



Abb.	Bestell-Nr.	Beschreibung	Vergleichs.-Nr.
1	400195	Spül 3	0467221
2	400725	Spül 3 mit Enthärter	0467222



Abb.	Best.-Nr.	Beschreibung	Vergleichs-Nr.
1	400726	Spül 2	0467225
2	400727	Spül 2 mit Enthärter	0467212
3	400728	Spül 2 mit Vollentsalzung	0467220



Abb.	Best.-Nr.	Beschreibung	V.-Nr.
1	400196	Spül 4 mit Temperaturanzeiger	0467210
2	400724	Spül 4 mit Temperaturanzeiger und Enthärter	0467211



Abb.	Best.-Nr.	Beschreibung	V.-Nr.
1	400197	Spül 6 mit Temperaturanzeiger	0467249
2	400729	Spül 6 mit Temperaturanzeiger und Enthärter	0467328

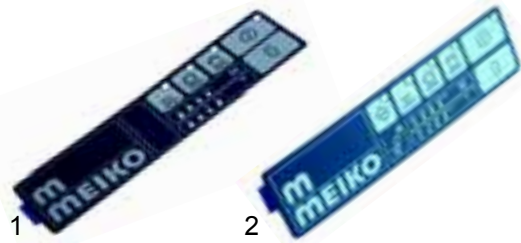

Abb.	Bestell-Nr.	Beschreibung	Geräte-Typ	Vergl.-Nr.
1	345481	Drucktaste		0121033
2	345482	Halter	FV25G, FR30G,	0121031
3	345483	Kontaktblock	FR40G, FV40N	0121032

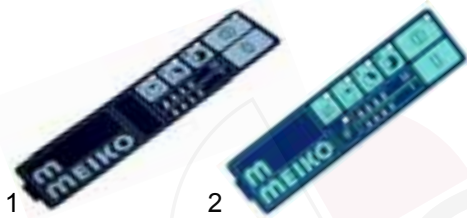

Abb.	Bestell-Nr.	Beschreibung	Geräte-Typ	Vergl.-Nr.
1	345477	Wahlschalter	FV25G, FR30G	0123262 0123270
2	345479	Wahlschalter	FR40G	0123012
3	345476	Wahlschalter	FV40N, DV40 (230V)	0123261 0123272

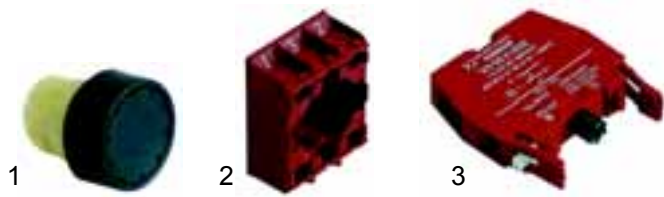

Abb.	Bestell-Nr.	Beschreibung	Geräte-Typ	Vergl.-Nr.
1	345478	Wahlschalter	FV120B, FV240B	0123001
2	345475	Wahlschalter	DV40 (400V), DV80, DV120D	0123260 0123271
3	345474	Wahlschalter	DV120B	0123259 0123273



Abb.	Bestell-Nr.	Beschreibung	Geräte-Typ	Vergl.-Nr.
1	501080	Mutter, 1 1/2"	FR40G,	0620138
2	501086	Rosette	FV120B,	0620321
3	501085	Knebel	FV240B	0620320



Abb.	Bestell-Nr.	Beschreibung	Geräte-Typ	Vergl.-Nr.
1	345060	Endschalter, 1 Schließer	F130G, FR40G,	0122007
2	345247	Endschalter, 2 Schließer	FV40N, DV40, DV80, DV120B,	0122016
3	345062	Endschalter, 1 Schließer + 10	FV130B, FV250B	0122017



Abb.	Best.-Nr.	Beschreibung	Geräte-Typ	V.-Nr.
1	345248	Magnetschalter	FV25G, FV28G, FR30G, FV30GS, FV20N, FV20T, FV40N, FV40T, FV40TFA, FV60E, FV70T, FV70TD, FV130D, FV250B, DV40, DV40T, DV40TFA, DV80, DV80T, DV80TFA, DV120B, DV120T	0122070
2	345801	Magnetschalter	FV130B, FV250B	0122024 0122056
3	345484	Schwimmerschalter	FV40TFA, FV70TD, DV40TFA, DV80TFA	9503380 9526211 0130028



Abb.	Best.-Nr.	Beschreibung	Geräte-Typ	Vergl.-Nr.
1	345807	Magnetschalter		0122037
2	345804	Magnetschalter		0122051
3	345486	Magnet	FV120B, FV240B, FV130B, FV250B	0122013



Abb.	Best.-Nr.	Beschreibung	Geräte-Typ	Vergl.-Nr.
1	345042	Mikroschalter	Universal	0122105
2	345043	Hebelsatz		0122106
3	359143	Signallampe		0150000



Abb.	Best.-Nr.	Beschreibung	Geräte-Typ	Vergl.-Nr.
1	360239	Timer, 120°	FV25G, FR30G	0124080
2	360240	Timer, 120°	FR40G	0124031
3	360198	Timer, 162°	FV40N, DV40	0124036



Abb.	Best.-Nr.	Beschreibung	Geräte-Typ	Vergl.-Nr.
1	360241	Timer, 480°	FV120B, FV240B	0214045
2	360199	Timer, 85°	DV80	0124090 0124040
3	360064	Timer, 56°	DV120B	0124039

Pressostate



Abb.	Best.-Nr.	Beschreibung	Geräte-Typ	Ver.-Nr.
1	541050	Pressostat, 50/30	FV25G, F28G, FR30G, FR40G, FV40T, FV120B, FV240B	0130009 0130019
1	541041	Pressostat, 62/30	FV30GS, FV60E, FV40N, FV130B, FV250D, DV40, DV80, DV120B	0130014 0130008
1	541146	Pressostat, 40/15	FV20N, FV20T, FV40TFA, FV70TD, FV110G, ECOstar430F/530F	0130026
1	541145	Pressostat, 90/25	DV40N, DV40T, DV40TFA, DV80T, DV80TFA, DV120T	0130027
2	541163	Pressostat, 50/30, 62/30	FV40N, DV40	0130010 8002014

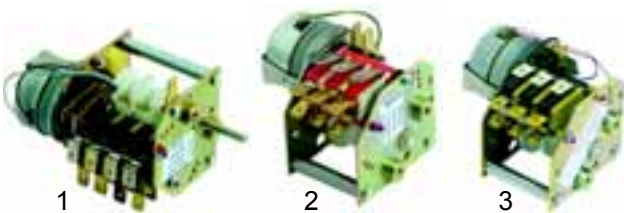

Abb.	Bestell.-Nr.	Beschreibung	Vergleichs-Nr.
1	380119	16A, 2S + 2Ö, 230V	0135512, 0135511, 0135223
1	380121	16A, 3S + 1Ö, 230V	0135221
2	380212	20A, 3S + 1Ö	0135209
2	380213	20A, 4S, 230V	0135200
3	380203	20A, 3S + 1Ö, 230V	0135204, 9520025
3	380204	20A, 4S, 230V	0135206, 9520026, 9518556
3	380219	25A, 3S + 1Ö, 230V	0135202, 9520024, 0135207, 9520023
3	380224	25A, 4S, 230V	0135205, 9518557, 0135208, 9518558, 9520028, 9520031

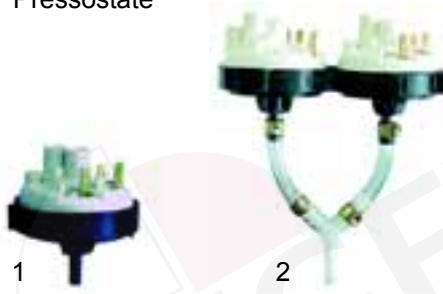

Abb.	Best.-Nr.	Beschreibung	Geräte-Typ	Ver.-Nr.
1	370001	Magnetventil, einfach		0113001
2	370126	Magnetventilkörper		0113200



Abb.	Best.-Nr.	Beschreibung	Geräte-Typ	Vergl.-Nr.
1	370002	Magnetventil, einfach		
2	370127	Magnetventilkörper		0113202



Abb.	Best.-Nr.	Beschreibung	Geräte-Typ	Vergl.-Nr.
1	370003	Magnetventil, doppelt		
2	370128	Magnetventilkörper		0113210 0113125



Abb.	Best.-Nr.	Beschreibung	Geräte-Typ	Vergl.-Nr.
1	370004	Magnetventil, doppelt		
2	370129	Magnetventilkörper		0113215



Abb.	Best.-Nr.	Beschreibung	Geräte-Typ	Ver.-Nr.
1	370179	Magnetventilkörper	FV120B, FV130B, FV240B, FV250B	0113222
2	371017	Magnetspule		0113223
3	371009	Magnetventilfeder		0113224
4	371122	Magnetventilsieb		0113098
5	371123	Mengenregler, 5L/h		0113236 9534217

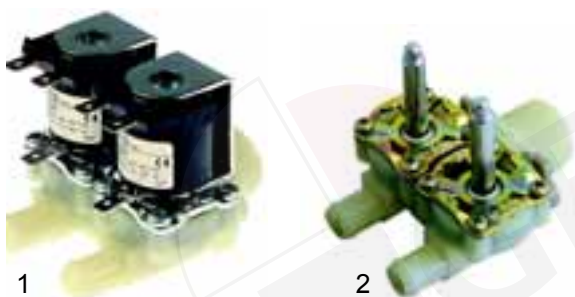

Abb.	Best.-Nr.	Beschreibung	Geräte-Typ	Vergl.-Nr.
1	370017	1-fach, gerade, 230V	ECOstar 530F	9005869
2	370015	1-fach, gewinkelt, 230V	ECOstar 430F	9000006



Abb.	Best.-Nr.	Beschreibung	Geräte-Typ	Ver.-Nr.
1	390103	Anlegethermostat, 56°C (NC)	Universal	0108047
2	390170	Anlegethermostat, 2-polig	Universal	0108051
3	390171	Anlegethermostat (Temperaturbegrenzer), 110°C (NC)	FV40TFA, FV70TD, DV40TFA, DV80TFA	0108043
4	510362	Dichtung	Universal	0108040



Abb.	Best.-Nr.	Beschreibung	Geräte-Typ	Ver.-Nr.
1	390123	Anlegethermostat, 50°C (NO)	Universal	0108053
2	390240	Sicherheitsthermostat, 105°C (NC)	Universal	0108038



Abb.	Best.-Nr.	Beschreibung	Geräte-Typ	V.-Nr.
1	390242	Thermostat, 0 - 90°C	Universal	0108037
1	390243	Thermostat, 0 - 90°C, längeres Kapillarrohr		0108041
2	390127	Thermostat, 0 - 95°C		0108030 0108036
3	390244	Sicherheitsthermostat, 120°C, 55.32529.190		9502526



Abb.	Best.-Nr.	Beschreibung	Geräte-Typ	Ver.-Nr.
1	110151	Knebel		0108018
2	501213	Tauchhülse		8400025
3	510420	Dichtung		0108019

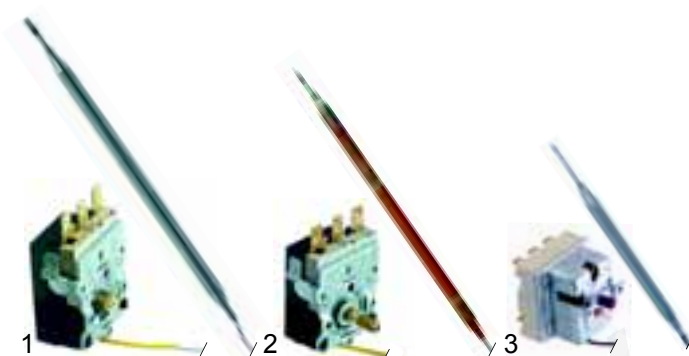

Abb.	Best.-Nr.	Beschreibung	Geräte-Typ	Ver.-Nr.
1	390108	Stabthermostat	FV120B, FV240B, DV120B	0108004
2	390241	Stabthermostat	FV120B, FV240B	0108005

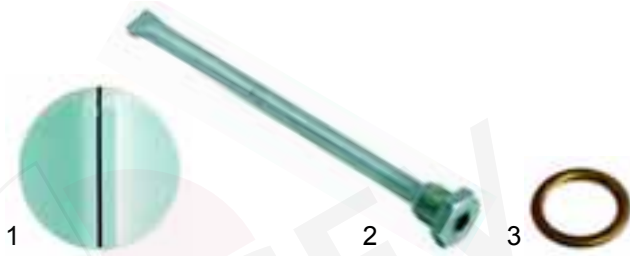

Abb.	Best.-Nr.	Beschreibung	Geräte-Typ	Ver.-Nr.
1	501075	Dichtung, 21 x 38 x 1,5	FV120B, FV240B, FV250B	0408006
2	501319	Mutter, 1/2"		8000025

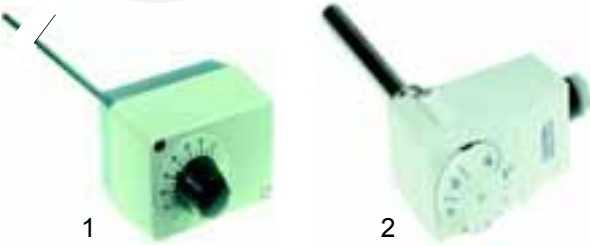

Abb.	Best.-Nr.	Beschreibung	Geräte-Typ	Ver.-Nr.
1	501178	Thermometer, 0 - 120°C		0465002
2	501076	Dichtung		0411005
3	501288	Mutter, 3/8"		8000024 8660045



Abb.	Best.-Nr.	Beschreibung	Geräte-Typ	Ver.-Nr.
1	400850	Hubmagnet, 205V DC		0140055
2	501283	O-Ring		0401038
3	400851	Gleichrichter	FV70TD	0140070
4	601080	Lüfter, 230V		0190032



Abb.	Best.-Nr.	Beschreibung	Geräte-Typ	Ver.-Nr.
1	380280	Zeitrelais, 30 sec.	FV120B, FV240B	0125013 0125031 9536544
2	400047	Zeitverzögerung, 6 - 39 sec	DV120B	0125035

Sicherungsautomaten

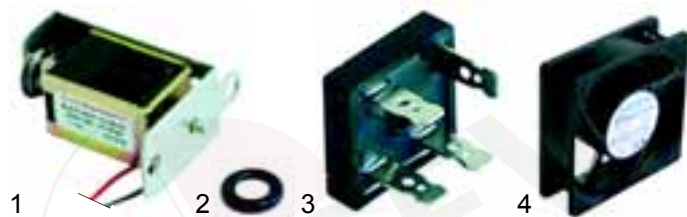

Pos.	Bestell-Nr.	Beschreibung	Geräte-Typ	Vergl.-Nr.
1	358210	K-type 4A		0145092
2	358214	K-type 10A		0145093
3	358216	K-type 16A		0145074
4	358217	K-type 20A		0145094
5	358104	B-type 16A		0145089
6	358105	B-type 20A		0145090
7	358106	B-type 25A		0145091

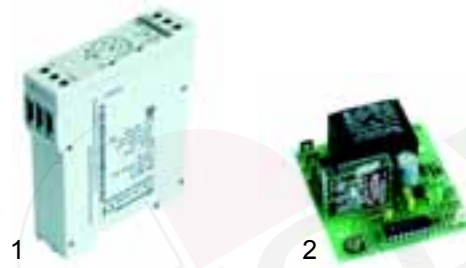
Feinsicherungen/träger



Pos.	Bestell-Nr.	Beschreibung	VPE	Vergl.-Nr.
1	358598	630mA		0145049
2	358600	1,0A		0145045
3	358601	1,25A		0145048
4	358602	1,6A	10 Stück	0145046
5	358603	2,0A		0145047
6	358607	6,3A		0145001
7	358704	8A		0145002



Pos.	Bestell-Nr.	Beschreibung	VPE	Vergl.-Nr.
1	358696	4A	10 Stück	0145013
2	358699	10A		0145000

Dosiertechnik



Abb.	Bestell-Nr.	Beschreibung	Geräte-Typ	Vergl.-Nr.
1	361032	Typ N6		0260070
2	501287	Winkelanschluss		0260049
3	361313	Druckanschluss		0260052
4	361080	O-Ring, 16 x 2mm		0260051
5	361085	O-Ring, 8 x 2mm		0260053
6	361086	Winkelanschluss		0260050

Ersatzteile, N5-Geräte



Abb.	Bestell-Nr.	Beschreibung	Geräte-T.	V.-Nr.
1	501287	Winkelanschluss		0260049
2	361084	Saug- und Druckanschluss		
3	361080	O-Ring, 16 x 2mm		0260051
4	361079	Kegelfeder		0260047
5	361077	Plattenventil		0260045
6	361078	Plattenventilhalterung		



Abb.	Bestell-Nr.	Beschreibung	Geräte-T.	V.-Nr.
1	361023	Dosiergerät DELTH10		0260024
2	361169	Saug- und Druckanschluss		0260021
3	361168	CNS-Ventil		0260027
4	361319	Dichtung		0260013
5	361122	Lippenventil		0260016
6	361188	Scheibe		-
7	361123	Membrane		
8	361237	Winkelanschluss		0620300



Abb.	Bestell-Nr.	Beschreibung	Vergl.-Nr.
1	361296	Santoprenschlauch, 4L/h (Reiniger)	0535694
1	361297	Santoprenschlauch, 6L/h (Reiniger)	0535695
2	361294	Silikonschlauch, 4L/h (Klarspüler)	0535688
2	361295	Silikonschlauch, 6L/h (Klarspüler)	0535690

Dosiergerät SR10



Abb.	Bestell-Nr.	Beschreibung	Vergl.-Nr.
1	361324	Reinigerdosiergerät, kpl., 4L/h	0535682
1	361325	Reinigerdosiergerät, kpl., 6L/h	0535683
2	361330	Klarspülerdosiergerät, kpl., 4L/h	0535680
2	361331	Klarspülerdosiergerät, kpl., 6L/h	0535681



Abb.	Bestell-Nr.	Beschreibung	Vergl.-Nr.
1	361326	Motor, 12V DV	0535684
2	361327	Reinigerkassette, kpl., 4L/h	0535692
2	361328	Reinigerkassette, kpl., 6L/h	0535693
3	361292	Klarspülerkassette, kpl., 4L/h	0535685
3	361293	Klarspülerkassette, kpl., 6L/h	0535686

Dosiergerät, Typ 8811



Abb.	Bestell-Nr.	Beschreibung	Vergl.-Nr.
1	361329	Reinigerdosiergerät, 10L/h	9500049 9531928
2	361332	Schlauch	9500092

SEKO-Dosiergeräte

Abb.	Best.-Nr.	Beschreibung	Vergl.-Nr.
1	361247	Reinigerdosiergerät, PR7-SAN, 230VAC	9504802 9533323
2	361246	Klarspülerdosiergerät, PR1-Sil, 230VAC	9503331



Abb.	Best.-Nr.	Beschreibung	Vergl.-Nr.
1	361321	Reinigerdosiergerät, PP7-SAN, 24VDC	9544292
2	361322	Klarspülerdosiergerät, PP1-Sil, 24VDC	9544293

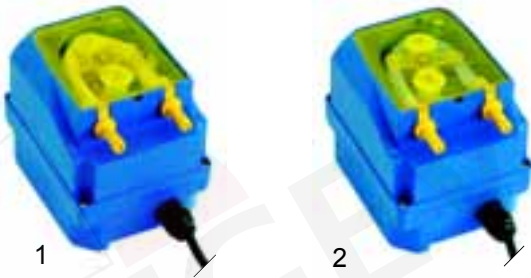

Abb.	Bestell-Nr.	Beschreibung	Vergl.-Nr.
1	361209	Elektronik, PR1/PR7	9505654 9505653
2	361238	Schlauch, kpl., PR7-SAN	9505651
3	361239	Schlauch, kpl., PR1-Sil	9505652

Dosiergerät SR25

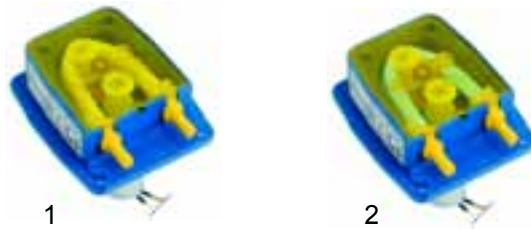
Pos.	Bestell-Nr.	Beschreibung	Vergl.-Nr.
1	361248	Dosiergerät, 2L/h	0535624
2	361249	Dosiergerät, 4L/h	0535625
3	361271	Dosiergerät, 6L/h	0535613
4	361272	Dosiergerät, 12L/h	0535620



Abb.	Bestell-Nr.	Beschreibung	Vergl.-Nr.
1	361335	Laufbandgehäuse	0535657
2	361336	Riegel	0535658
3	361333	Schlauch, kpl., 2L, 4L, 12L/h (4 x 1,5)	0535676
3	361334	Schlauch, kpl., 6L/h (5 x 1,5)	0535664



Abb.	Bestell-Nr.	Beschreibung	Vergl.-Nr.
1	361245	Elektrode	0620437
2	501289	Dichtung	0217432
3	501290	Mutter	0620162
4	361274	Elektrode	8000014



Abb.	Bestell-Nr.	Beschreibung	Vergl.-Nr.
1	501081	Wassereinlauf	0620245
2	501303	Mutter	0335019
3	361270	Wanneneinlauf (CNS)	
4	501003	Behälterfilter	8001801 0260096

Heizkörper
Tankheizkörper

Abb.	Best.-Nr.	Lstg.	Heizkörper/ Spannung	Geräte-Typ	V.-Nr.
1	415507	2kW	1/230V	Universal	0101152
2	415508	3kW	3/230V	DV40, DV80, DV120B	0101151
3	415509	6kW	3/230V	FV70TD, FV120B, FV130B	0101158



Abb.	Best.-Nr.	Lstg.	Heizkörper/ Spannung	Geräte-Typ	V.-Nr.
1	416220	6kW	3/230V		0101145
2	415510	9kW	3/230V		0101149

Einschraubheizkörper, 1 1/2"

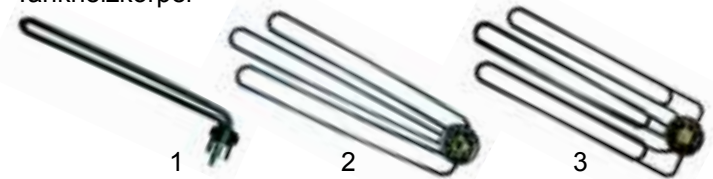
Abb.	B.-Nr.	Lstg.	Heizkörper/ Spannung	Geräte-Typ	V.-Nr.
1	415506	3kW	3/230V	FV25G, FR30G, FV40N, DV40	0101140
2	415502	4,5kW	3/230V	FV40N, DV120B	0101142
3	415503	6kW	3/230V	FV120B, FV130B, FV240B, FV250B, DV40, DV80, DV120B	0101144
3	415504	7,5kW	3/230V	FV120B, FV240B, DV120B	0101146
4	415505	9kW	3/230V	FV120B, FV240B, FV250B, DV80	0101148

Einschraubheizkörper, 1 1/2", mit Tauchhülse

Abb.	B.-Nr.	Leistung	Heizkörper/ Spannung	Geräte-Typ	V.-Nr.
1	416221	3kW	3/230V		9502869
2	416222	6kW	3/230V		9502870
3	416223	9kW	3/230V		9502872

Napfflanschheizkörper, mit 2 Tauchhülsen

Abb.	B.-Nr.	Lstg.	Heizkörper/ Spannung	Geräte-Typ	V.-Nr.
1	415693	3kW	3/230V	FR30G, FR40G, FV20 bis FV70, DV40 bis DV120B	0101150 9504228
2	415598	4,5kW	3/230V	FV20 bis FV70, DV120B	0101163 9504234
3	415663	6kW	3/230V	FV20 bis FV70, FV130B, DV40 bis DV120B	0101143 9504236
3	415873	7,5kW	3/230V	FV40 bis FV70, FV130B, DV40 bis DV120B	0101167 9504237
4	415692	9kW	3/230V	FV130B, FV250B, DV40 bis DV120B	0101166 9500498

Heizkörperdichtungen

Abb.	Best.-Nr.	Beschreibung	Geräte-Typ	Vergl.-Nr.
1	510364	Dichtung	Universal	0101175
2	510424	Cu-Dichtung		0409008
3	510408	O-Ring-Dichtung		0101176
4	550002	Spannbügel		0101183

Heizkörperabdeckung

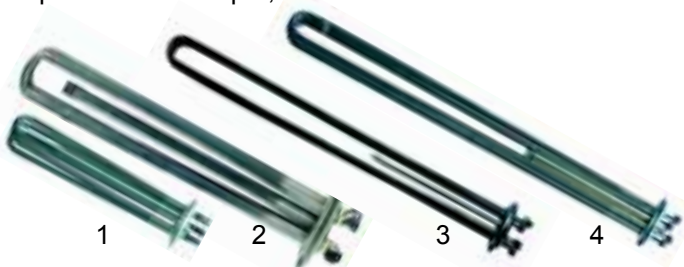
Abb.	Best.-Nr.	Beschreibung	Geräte-Typ	Vergl.-Nr.
1	520245	Einschraubheizkörper	Universal	8400056 0620315
2	501084	Napfflanschheizkörper		0620312

Boiler
Napfflanschheizkörper

Abb.	Bestell-Nr.	Beschreibung	Geräte-Typ	Vergl.-Nr.
1	501261	Boiler, max. 3kW	FV25G, FR30G, FV30GS, FR40G	8400122
2	501268	Boiler, max. 3kW	FV28G	8400280



Abb.	Bestell-Nr.	Beschreibung	Geräte-Typ	Ver.-Nr.
1	501279	Boiler, max. 7,5kW	FV20T, FV40T, FV70T, FV110G	8400267
2	501260	Boiler, max. 7,5kW	FV40N, FV60E	8400112

Pumpen



Abb.	Best.-Nr.	Beschreibung	Geräte-Typ	V.-Nr.
1	500042	Laugenpumpe		0535502
2	500274	FIR 0221, 0,11kW/230V	FV20TFA, FV40TFA, FV70TD, FV28GFA, DV40TFA, DV80TFA	0501166



Abb.	Bestell-Nr.	Beschreibung	Geräte-Typ	Vergl.-Nr.
1	500285	Motor	DR90	0501016
2	500286	Motor	DV111	0501024
3	501174	Gleitringdichtung	DR90, DV111	0403002

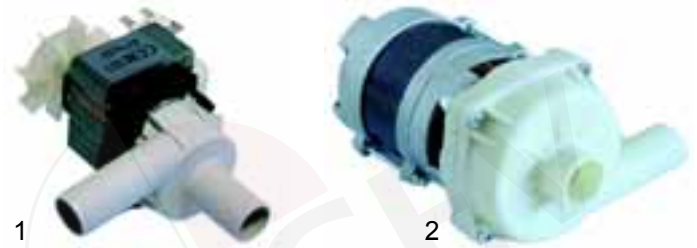

Abb.	Best.-Nr.	Beschreibung	Geräte-Typ	V.-Nr.
1	501072	Manschette		0403009
2	501073	Gleitring		0403010
3	501071	Gleitringdichtung	FV250B	0403003
4	501118	Pumpenrad		8100218
5	501117	Mutter		8100217



Abb.	Best.-Nr.	Beschreibung	Geräte-Typ	V.-Nr.
1	500288	Motor		0501040
2	501087	Motorträger	FV250B	0620333
3	501119	Flansch mit Distanzbolzen		8101063



Abb.	Bestell-Nr.	Beschreibung	Geräte-Typ	Ver.-Nr.
1	501266	Boiler, max. 7,5kW	DV40	8400208
2	501285	Boiler, max. 9kW	DV80, DV80T, DV120B	8400269 8400030



Abb.	Best.-Nr.	Beschreibung	Geräte-Typ	V.-Nr.
1	501159	Boiler, max. 7,5kW	FV20TFA, FV40TFA, FV70TD	8400304 8400328
2	501304	Boiler, max. 9kW	DV40TFA, DV80TFA	8400316 8400357



Abb.	Bestell-Nr.	Beschreibung	Geräte-Typ	Vergl.-Nr.
1	501305	Boiler, max. 3kW	ECOstar 430F	9505183
2	501306	Boiler, max. 4,5kW	ECOstar 530F	9505184

Einschraubheizkörper



Pos.	Bestell-Nr.	Beschreibung	Geräte-Typ	Vergl.-Nr.
1	501265	Boiler, max. 12kW	DV120B, FV130	8400271 8400172



Abb.	Best.-Nr.	Beschreibung	Geräte-Typ	V.-Nr.
1	500038	FIR3911	FR30G, FR40G, FV20 bis FV110G, DV40, ECOstar 430F/530F	0501085 0501120 0501125 0501126
2	500287	FIR2256, 073kW/230V	DV80, DV160	0501135



Abb.	Best.-Nr.	Beschreibung	Geräte-Typ	V.-Nr.
1	500111	FIR1241, 1,1kW/400V	DV120, DV240	0501131 0501129 0501134 0501146
2	500031	FIR1205, 2,0kW/400V	DV120, FV120D, FV130B, FV240B, DV260B	0501032 0501086



Abb.	Best.-Nr.	Beschreibung	Geräte-Typ	V.-Nr.
1	500289	FIR1276, 055kW/400V		0501088 0501147 0501163
2	500029	FIR1295, 0,9kW/400V	DV80	0501084 0501089 0501118



Pumpe		1 Laufrad		2 Gleitringdichtung		3 Gehäusedichtung		4 Pumpendeckel		5 Kondensator	
B.-Nr.	V.-Nr.	B.-Nr.	V.-Nr.	B.-Nr.	V.-Nr.	B.-Nr.	V.-Nr.	B.-Nr.	V.-Nr.	B.-Nr.	V.-Nr.
500274	0501166	501309	0501170	501311	0501168	501312	0501171	501310	0501169	365012	0501173
500038	0501085	510610	0501092	510692	0501095	510552	0501094	521510	0501091	365014	0501090
500287	0501084	501313	0501138	510692	0501095	501552	0501157	521510	0501091	365021	0501136
500289	0501088	501314	0501081	510692	0501162	501552	0501094	521510	0501091	-	-
500029	0501089	521213	0501100	510693	0501160	510551	0501101	510502	0501103	-	-
500111	0501129	509011	0501132	510693	0501161	510551	0501101	510503	0501097	-	-
500031	0501082	501317	0501110	510693	0501163	510551	0501101	510503	0501097	-	-