



Pumpen

Wasch- und Nachspülpumpen

FIR

Pumpen



1

GEV-Nr.	500248	Vergl.-Nr.	4186.1500
Beschreibung	Pumpe Ausgang ø 27mm Typ 4186.1500 230V 50Hz Phasen 1 0,25kW 0,33PS L 170mm Laufrichtung rechts Kondensator 12,5µF FIR		
Ersatzteile zu	500248		
	GEV-Nr.	365014	Vergl.-Nr. —
	Betriebskondensator Kapazität 12,5µF 400V		
	GEV-Nr.	502012	Vergl.-Nr. N/A
	Pumpendeckelunterteil für Waschpumpe		
	GEV-Nr.	502015	Vergl.-Nr. N/A
	Laufrad ø 86mm H 22mm Achsaufnahme ø 9/8mm		
	GEV-Nr.	503147	Vergl.-Nr. —
	Pumpendeckeldichtung Materialstärke 3,53mm		
	GEV-Nr.	510695	Vergl.-Nr. N/A
	Gleitringdichtung Höhe Gegenring 5,5mm		
Zubehör zu	500248		
	GEV-Nr.	521730	Vergl.-Nr. N/A
	Flanschdichtung EPDM Materialstärke 5mm ID ø 155mm		



1

GEV-Nr.	501460	Vergl.-Nr.	4186.1500
Beschreibung	Pumpe Ausgang ø 27mm Typ 4186.1500 230V 50Hz Phasen 1 0,25kW 0,33PS L 170mm Laufrichtung rechts Kondensator 12,5µF FIR Ausgang ø 27mm		
Ersatzteile zu	501460		
	GEV-Nr.	502012	Vergl.-Nr. N/A
	Pumpendeckelunterteil für Waschpumpe		
	GEV-Nr.	502015	Vergl.-Nr. N/A
	Laufrad ø 86mm H 22mm Achsaufnahme ø 9/8mm		
	GEV-Nr.	503147	Vergl.-Nr. —
	Pumpendeckeldichtung Materialstärke 3,53mm		
	GEV-Nr.	510695	Vergl.-Nr. N/A
	Gleitringdichtung Höhe Gegenring 5,5mm		
Zubehör zu	501460		
	GEV-Nr.	365014	Vergl.-Nr. —
	Betriebskondensator Kapazität 12,5µF 400V		
	GEV-Nr.	521730	Vergl.-Nr. N/A
	Flanschdichtung EPDM Materialstärke 5mm ID ø 155mm		



1

GEV-Nr.	499004	Vergl.-Nr.	1291.1670
Beschreibung	Pumpe Eingang ø 28mm Ausgang ø 26mm Typ 1291.1670 230V 50Hz Phasen 1 0,07kW 0,1PS L 195mm Laufrichtung rechts Kondensator 5µF FIR		
Ersatzteile zu	499004		
	GEV-Nr.	365017	Vergl.-Nr. —
	Betriebskondensator Kapazität 5µF 450V		



1

GEV-Nr.	500387	Vergl.-Nr.	2211.1408
Beschreibung	Pumpe Eingang ø 28mm Ausgang ø 26mm Typ 2211.1408 220V 50Hz Phasen 1 0,074kW 0,1PS L 190mm Laufrichtung links Kondensator 5µF FIR 2600U/min		
Ersatzteile zu	500387		
	GEV-Nr.	365017	Vergl.-Nr. —
	Betriebskondensator Kapazität 5µF 450V		
	GEV-Nr.	510384	Vergl.-Nr. N/A
	Pumpendeckel Eingang ø 28mm Ausgang ø 26mm ø 100mm		
	GEV-Nr.	510695	Vergl.-Nr. N/A
	Gleitringdichtung Höhe Gegenring 5,5mm		
	GEV-Nr.	521203	Vergl.-Nr. N/A
	Laufrad ø 72mm H 18mm Gewinde M7 Welle ø 11mm		
	GEV-Nr.	521703	Vergl.-Nr. N/A
	Pumpendeckeldichtung EPDM Materialstärke 2,5mm		



1

GEV-Nr.	500037	Vergl.-Nr.	2211.1402 2211.1410
Beschreibung	Pumpe Eingang ø 28mm Ausgang ø 26mm Typ 2211.1410 230V 50Hz Phasen 1 0,074kW 0,1PS L 190mm Laufrichtung links Kondensator 5µF FIR		
Ersatzteile zu	500037		
	GEV-Nr.	365017	Vergl.-Nr. —
	Betriebskondensator Kapazität 5µF 450V		
	GEV-Nr.	510384	Vergl.-Nr. N/A
	Pumpendeckel Eingang ø 28mm Ausgang ø 26mm ø 100mm		
	GEV-Nr.	510695	Vergl.-Nr. N/A
	Gleitringdichtung Höhe Gegenring 5,5mm		
	GEV-Nr.	521203	Vergl.-Nr. N/A
	Laufrad ø 72mm H 18mm Gewinde M7 Welle ø 11mm		
	GEV-Nr.	521703	Vergl.-Nr. N/A
	Pumpendeckeldichtung EPDM Materialstärke 2,5mm		



1

GEV-Nr.	499079	Vergl.-Nr.	2211.1610
Beschreibung	Pumpe Eingang ø 28mm Ausgang ø 26mm Typ 2211.1610 220-240V 50Hz Phasen 1 0,07kW 0,1PS Laufrichtung links Kondensator 5µF FIR		
Ersatzteile zu	499079		
	GEV-Nr.	365017	Vergl.-Nr. —
	Betriebskondensator Kapazität 5µF 450V		
	GEV-Nr.	510384	Vergl.-Nr. N/A
	Pumpendeckel Eingang ø 28mm Ausgang ø 26mm ø 100mm		

Tabellenfortsetzung auf der nächsten Seite



Ersatzteile zu 499079			
	GEV-Nr.	510695	Vergl.-Nr. N/A
Gleitringdichtung Höhe Gegenring 5,5mm			
	GEV-Nr.	521203	Vergl.-Nr. N/A
Laufрад ø 72mm H 18mm Gewinde M7 Welle ø 11mm			
	GEV-Nr.	521703	Vergl.-Nr. N/A
Pumpendeckeldichtung EPDM Materialstärke 2,5mm			



1			
GEV-Nr.	500457	Vergl.-Nr.	2213.1417
Beschreibung	Pumpe Eingang ø 28mm Ausgang ø 26mm Typ 2213.1417 230V 50Hz Phasen 1 0,15kW 0,2PS L 198mm Laufrichtung links Kondensator 6,3µF FIR		
Ersatzteile zu 500457			
	GEV-Nr.	365012	Vergl.-Nr. —
Betriebskondensator Kapazität 6,3µF 450V			
	GEV-Nr.	510384	Vergl.-Nr. N/A
Pumpendeckel Eingang ø 28mm Ausgang ø 26mm ø 100mm			
	GEV-Nr.	510695	Vergl.-Nr. N/A
Gleitringdichtung Höhe Gegenring 5,5mm			
	GEV-Nr.	521703	Vergl.-Nr. N/A
Pumpendeckeldichtung EPDM Materialstärke 2,5mm			





1			
GEV-Nr.	500465	Vergl.-Nr.	2213.1601
Beschreibung	Pumpe Eingang ø 28mm Ausgang ø 26mm Typ 2213.1601 230V 50Hz Phasen 1 0,11kW 0,15PS L 195mm Laufrichtung links Kondensator 5µF FIR		
Ersatzteile zu 500465			
	GEV-Nr.	365017	Vergl.-Nr. —
Betriebskondensator Kapazität 5µF 450V			
	GEV-Nr.	510384	Vergl.-Nr. N/A
Pumpendeckel Eingang ø 28mm Ausgang ø 26mm ø 100mm			
	GEV-Nr.	510695	Vergl.-Nr. N/A
Gleitringdichtung Höhe Gegenring 5,5mm			
	GEV-Nr.	511711	Vergl.-Nr. —
O-Ring EPDM Materialstärke 3,53mm ID ø 78,97mm			
	GEV-Nr.	521266	Vergl.-Nr. N/A
Laufрад ø 67mm H 18mm Gewinde M7 Welle ø 11mm			



1			
GEV-Nr.	500028	Vergl.-Nr.	2213.1912
Beschreibung	Pumpe Eingang ø 28mm Ausgang ø 26mm Typ 2213.1912 230V 50Hz Phasen 1 0,11kW 0,15PS L 195mm Laufrichtung links Kondensator 6,3µF FIR		
Ersatzteile zu 500028			
	GEV-Nr.	365012	Vergl.-Nr. —
Betriebskondensator Kapazität 6,3µF 450V			
	GEV-Nr.	510384	Vergl.-Nr. N/A
Pumpendeckel Eingang ø 28mm Ausgang ø 26mm ø 100mm			
	GEV-Nr.	510695	Vergl.-Nr. N/A
Gleitringdichtung Höhe Gegenring 5,5mm			

Tabellenfortsetzung auf der nächsten Seite

Ersatzteile zu 500028			
	GEV-Nr.	521203	Vergl.-Nr. N/A
Laufrad ø 72mm H 18mm Gewinde M7 Welle ø 11mm			
	GEV-Nr.	521703	Vergl.-Nr. N/A
Pumpendeckeldichtung EPDM Materialstärke 2,5mm			





GEV-Nr.	500685	Vergl.-Nr.	2214.1403
Beschreibung	Pumpe Eingang ø 28mm Ausgang ø 26mm Typ 2214.1403 230V 50Hz Phasen 1 0,11kW 0,15PS L 197mm Laufrichtung rechts Kondensator 6,3µF FIR		
Ersatzteile zu 500685			
	GEV-Nr.	365012	Vergl.-Nr. —
Betriebskondensator Kapazität 6,3µF 450V			
	GEV-Nr.	510510	Vergl.-Nr. X2212-HP0,10_(1)
Pumpendeckel Pumpentyp 2212/2228/2229/2211			
	GEV-Nr.	510695	Vergl.-Nr. N/A
Gleitringdichtung Höhe Gegenring 5,5mm			
	GEV-Nr.	521203	Vergl.-Nr. N/A
Laufrad ø 72mm H 18mm Gewinde M7 Welle ø 11mm			
	GEV-Nr.	521703	Vergl.-Nr. N/A
Pumpendeckeldichtung EPDM Materialstärke 2,5mm			



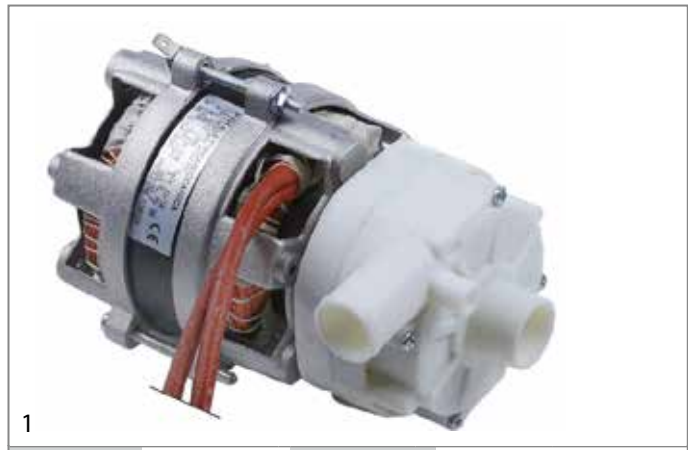

GEV-Nr.	500948	Vergl.-Nr.	2214.1600
Beschreibung	Pumpe Eingang ø 28mm Ausgang ø 26mm Typ 2214.1600 230V 50Hz Phasen 1 0,11kW 0,15PS L 197mm Laufrichtung rechts Kondensator 6,3µF FIR		
Ersatzteile zu 500948			
	GEV-Nr.	365012	Vergl.-Nr. —
Betriebskondensator Kapazität 6,3µF 450V			
	GEV-Nr.	510510	Vergl.-Nr. X2212-HP0,10_(1)
Pumpendeckel Pumpentyp 2212/2228/2229/2211			
	GEV-Nr.	510695	Vergl.-Nr. N/A
Gleitringdichtung Höhe Gegenring 5,5mm			
	GEV-Nr.	521203	Vergl.-Nr. N/A
Laufrad ø 72mm H 18mm Gewinde M7 Welle ø 11mm			
	GEV-Nr.	521703	Vergl.-Nr. N/A
Pumpendeckeldichtung EPDM Materialstärke 2,5mm			



GEV-Nr.	499090	Vergl.-Nr.	2222.1900
Beschreibung	Pumpe Eingang ø 28mm Ausgang ø 26mm Typ 2222.1900 230V 50Hz Phasen 1 0,22kW 0,3PS L 191mm Laufrichtung links Kondensator 5µF FIR		
Ersatzteile zu 499090			
	GEV-Nr.	365017	Vergl.-Nr. —
Betriebskondensator Kapazität 5µF 450V			
	GEV-Nr.	510384	Vergl.-Nr. N/A
Pumpendeckel Eingang ø 28mm Ausgang ø 26mm ø 100mm			

Tabellenfortsetzung auf der nächsten Seite

Ersatzteile zu 499090				
	GEV-Nr.	510532	Vergl.-Nr.	X2228-HP.0,20_(1)
Laufрад ø 72mm H 22mm Pumpentyp B229 Gewinde M7				
	GEV-Nr.	510695	Vergl.-Nr.	N/A
Gleitringdichtung Höhe Gegenring 5,5mm				
	GEV-Nr.	521703	Vergl.-Nr.	N/A
Pumpendeckeldichtung EPDM Materialstärke 2,5mm				



1

GEV-Nr.	500015	Vergl.-Nr.	2228.1900	
Beschreibung	Pumpe Eingang ø 28mm Ausgang ø 26mm Typ 2228.1900 230V 50Hz Phasen 1 0,15kW 0,2PS L 190mm Laufriichtung rechts Kondensator 5µF FIR			
Ersatzteile zu 500015				
	GEV-Nr.	365017	Vergl.-Nr.	—
Betriebskondensator Kapazität 5µF 450V				
	GEV-Nr.	510510	Vergl.-Nr.	X2212-HP.0,10_(1)
Pumpendeckel Pumpentyp 2212/2228/2229/2211				
	GEV-Nr.	510532	Vergl.-Nr.	X2228-HP.0,20_(1)
Laufрад ø 72mm H 22mm Pumpentyp B229 Gewinde M7				
	GEV-Nr.	510695	Vergl.-Nr.	N/A
Gleitringdichtung Höhe Gegenring 5,5mm				
	GEV-Nr.	521703	Vergl.-Nr.	N/A
Pumpendeckeldichtung EPDM Materialstärke 2,5mm				





1



GEV-Nr.	500399	Vergl.-Nr.	4208.1910	
Beschreibung	Pumpe Eingang ø 28mm Ausgang ø 26mm Typ 4208.1910 230V 50Hz Phasen 1 0,075kW 0,1PS L 190mm Laufriichtung links Kondensator 5µF FIR			
Ersatzteile zu 500399				
	GEV-Nr.	365017	Vergl.-Nr.	—
Betriebskondensator Kapazität 5µF 450V				
	GEV-Nr.	510384	Vergl.-Nr.	N/A
Pumpendeckel Eingang ø 28mm Ausgang ø 26mm ø 100mm				
	GEV-Nr.	510695	Vergl.-Nr.	N/A
Gleitringdichtung Höhe Gegenring 5,5mm				
	GEV-Nr.	521203	Vergl.-Nr.	N/A
Laufрад ø 72mm H 18mm Gewinde M7 Welle ø 11mm				
	GEV-Nr.	521703	Vergl.-Nr.	N/A
Pumpendeckeldichtung EPDM Materialstärke 2,5mm				



1

GEV-Nr.	500394	Vergl.-Nr.	4213.1500	
Beschreibung	Pumpe Eingang ø 28mm Ausgang ø 26mm Typ 4213.1500 230V 50Hz Phasen 1 0,28kW 0,38PS L 195mm Laufriichtung links Kondensator 6,3µF FIR			
Ersatzteile zu 500394				
	GEV-Nr.	365012	Vergl.-Nr.	—
Betriebskondensator Kapazität 6,3µF 450V				
	GEV-Nr.	510384	Vergl.-Nr.	N/A
Pumpendeckel Eingang ø 28mm Ausgang ø 26mm ø 100mm				





Tabellenfortsetzung auf der nächsten Seite

Ersatzteile zu 500394				
	GEV-Nr.	510532	Vergl.-Nr.	X2228-HP0,20_(1)
Laufrad ø 72mm H 22mm Pumpentyp B229 Gewinde M7				
	GEV-Nr.	510695	Vergl.-Nr.	N/A
Gleitringdichtung Höhe Gegenring 5,5mm				
	GEV-Nr.	521703	Vergl.-Nr.	N/A
Pumpendeckeldichtung EPDM Materialstärke 2,5mm				





GEV-Nr.	501446	Vergl.-Nr.	4213E2250	
Beschreibung	Pumpe Eingang ø 28mm Ausgang ø 26mm Typ 4213E2250 220-240V 50Hz Phasen 1 0,19kW 0,26PS L 190mm Laufrichtung links Kondensator 5µF FIR			
Ersatzteile zu 501446				
	GEV-Nr.	365017	Vergl.-Nr.	—
Betriebskondensator Kapazität 5µF 450V				
	GEV-Nr.	510384	Vergl.-Nr.	N/A
Pumpendeckel Eingang ø 28mm Ausgang ø 26mm ø 100mm				
	GEV-Nr.	510695	Vergl.-Nr.	N/A
Gleitringdichtung Höhe Gegenring 5,5mm				
	GEV-Nr.	521203	Vergl.-Nr.	N/A
Laufrad ø 72mm H 18mm Gewinde M7 Welle ø 11mm				
	GEV-Nr.	521703	Vergl.-Nr.	N/A
Pumpendeckeldichtung EPDM Materialstärke 2,5mm				



GEV-Nr.	500030	Vergl.-Nr.	4226.2540	
Beschreibung	Pumpe Eingang ø 28mm Ausgang ø 26mm Typ 4226.2540 230/400V 50Hz Phasen 3 0,35kW 0,5PS L 260mm Laufrichtung rechts FIR			
Ersatzteile zu 500030				
	GEV-Nr.	510510	Vergl.-Nr.	X2212-HP0,10_(1)
Pumpendeckel Pumpentyp 2212/2228/2229/2211				
	GEV-Nr.	510690	Vergl.-Nr.	N/A
Gleitringdichtung für Wellen ø 8mm				
	GEV-Nr.	521202	Vergl.-Nr.	N/A
Laufrad ø 72mm H 17mm Gewinde M5L				
	GEV-Nr.	521703	Vergl.-Nr.	N/A
Pumpendeckeldichtung EPDM Materialstärke 2,5mm				



GEV-Nr.	500999	Vergl.-Nr.	4226.2541	
Beschreibung	Pumpe Eingang ø 28mm Ausgang ø 26mm Typ 4226.2541 230/400V 50Hz Phasen 3 0,35kW 0,5PS L 260mm Laufrichtung rechts FIR			
Ersatzteile zu 500999				
	GEV-Nr.	510510	Vergl.-Nr.	X2212-HP0,10_(1)
Pumpendeckel Pumpentyp 2212/2228/2229/2211				
	GEV-Nr.	510690	Vergl.-Nr.	N/A
Gleitringdichtung für Wellen ø 8mm				

Tabellenfortsetzung auf der nächsten Seite



Ersatzteile zu 500999			
	GEV-Nr.	521279	Vergl.-Nr. N/A
Laufrad ø 64mm H 17mm Gewinde M5L Schaufeln 3			
	GEV-Nr.	521703	Vergl.-Nr. N/A
Pumpendeckeldichtung EPDM Materialstärke 2,5mm			



1

GEV-Nr.	500019	Vergl.-Nr.	B229.1405
Beschreibung	Pumpe Eingang ø 28mm Ausgang ø 26mm Typ B229.1405 230V 50Hz Phasen 1 0,22kW 0,3PS L 200mm Laufrichtung rechts Kondensator 5µF FIR		
Ersatzteile zu 500019			
	GEV-Nr.	365017	Vergl.-Nr. —
Betriebskondensator Kapazität 5µF 450V			
	GEV-Nr.	510510	Vergl.-Nr. X2212-HP,0,10_(1)
Pumpendeckel Pumpentyp 2212/2228/2229/2211			
	GEV-Nr.	510532	Vergl.-Nr. X2228-HP,0,20_(1)
Laufrad ø 72mm H 22mm Pumpentyp B229 Gewinde M7			
	GEV-Nr.	510695	Vergl.-Nr. N/A
Gleitringdichtung Höhe Gegenring 5,5mm			
	GEV-Nr.	521703	Vergl.-Nr. N/A
Pumpendeckeldichtung EPDM Materialstärke 2,5mm			





1



GEV-Nr.	499227	Vergl.-Nr.	B236.1400
Beschreibung	Pumpe Eingang ø 28mm Ausgang ø 26mm Typ B236.1400 220-240V 50Hz Phasen 1 0,14kW 0,2PS L 200mm Laufrichtung links Kondensator 6,3µF FIR		
Ersatzteile zu 499227			
	GEV-Nr.	365012	Vergl.-Nr. —
Betriebskondensator Kapazität 6,3µF 450V			
	GEV-Nr.	510384	Vergl.-Nr. N/A
Pumpendeckel Eingang ø 28mm Ausgang ø 26mm ø 100mm			
	GEV-Nr.	510695	Vergl.-Nr. N/A
Gleitringdichtung Höhe Gegenring 5,5mm			
	GEV-Nr.	521203	Vergl.-Nr. N/A
Laufrad ø 72mm H 18mm Gewinde M7 Welle ø 11mm			
	GEV-Nr.	521703	Vergl.-Nr. N/A
Pumpendeckeldichtung EPDM Materialstärke 2,5mm			



1

GEV-Nr.	499279	Vergl.-Nr.	B246.2520
Beschreibung	Pumpe Eingang ø 28mm Ausgang ø 26mm Typ B246.2520 230/400V 50Hz Phasen 3 0,18kW 0,25PS L 265mm Laufrichtung rechts FIR		
Ersatzteile zu 499279			
	GEV-Nr.	510510	Vergl.-Nr. X2212-HP,0,10_(1)
Pumpendeckel Pumpentyp 2212/2228/2229/2211			
	GEV-Nr.	510532	Vergl.-Nr. X2228-HP,0,20_(1)
Laufrad ø 72mm H 22mm Pumpentyp B229 Gewinde M7			

Tabellenfortsetzung auf der nächsten Seite

Ersatzteile zu 499279			
	GEV-Nr.	510695	Vergl.-Nr. N/A
Gleitringdichtung Höhe Gegenring 5,5mm			
	GEV-Nr.	521703	Vergl.-Nr. N/A
Pumpendeckeldichtung EPDM Materialstärke 2,5mm			



GEV-Nr.	499261	Vergl.-Nr.	5213.2160
Beschreibung	Pumpe Eingang ø 30mm Ausgang ø 26mm Typ 5213.2160 208-240V 60Hz Phasen 1 0,28kW L 195mm Laufrichtung links Kondensator 6,3µF FIR		







GEV-Nr.	499262	Vergl.-Nr.	5213.2450
Beschreibung	Pumpe Eingang ø 30mm Ausgang ø 26mm Typ 5213.2450 220-240V 50Hz Phasen 1 0,28kW L 195mm Laufrichtung links Kondensator 6,3µF FIR		



GEV-Nr.	499266	Vergl.-Nr.	5213.3951
Beschreibung	Pumpe Eingang ø 30mm Ausgang ø 26mm Typ 5213.3951 400V 50Hz Phasen 1 0,28kW L 195mm Laufrichtung links Kondensator 6,3µF FIR		



GEV-Nr.	500598	Vergl.-Nr.	5213EB2450 5213EB2451
Beschreibung	Pumpe Eingang ø 30mm Ausgang ø 26mm Typ 5213E2450 230V 50Hz Phasen 1 0,22kW 0,1PS L 190mm Laufrichtung links Kondensator 5µF FIR		

Ersatzteile zu 500598			
	GEV-Nr.	365017	Vergl.-Nr. —
Betriebskondensator Kapazität 5µF 450V			
	GEV-Nr.	502265	Vergl.-Nr. 5213EB2450
Pumpendeckel Eingang ø 30mm Ausgang ø 26mm			
	GEV-Nr.	510695	Vergl.-Nr. N/A
Gleitringdichtung Höhe Gegenring 5,5mm			
	GEV-Nr.	521203	Vergl.-Nr. N/A
Laufgrad ø 72mm H 18mm Gewinde M7 Welle ø 11mm			
	GEV-Nr.	532718	Vergl.-Nr. N/A
O-Ring EPDM Materialstärke 4mm ID ø 80mm			







1

GEV-Nr.	499137	Vergl.-Nr.	5213E2452 5213EB2450
Beschreibung	Pumpe Eingang ø 30mm Ausgang ø 26mm Typ 5213E2452 220/240V 50Hz Phasen 1 0,07kW 0,1PS L 195mm Laufrichtung links Kondensator 5µF FIR		
Ersatzteile zu	499137		
	GEV-Nr.	365017	Vergl.-Nr. —
	Betriebskondensator Kapazität 5µF 450V		
	GEV-Nr.	502250	Vergl.-Nr. —
	O-Ring EPDM Materialstärke 4mm ID ø 74mm		
	GEV-Nr.	502265	Vergl.-Nr. 5213EB2450
	Pumpendeckel Eingang ø 30mm Ausgang ø 26mm		
	GEV-Nr.	510695	Vergl.-Nr. N/A
	Gleitringdichtung Höhe Gegenring 5,5mm		
	GEV-Nr.	521203	Vergl.-Nr. N/A
	Laufrad ø 72mm H 18mm Gewinde M7 Welle ø 11mm		
	GEV-Nr.	532718	Vergl.-Nr. N/A
	O-Ring EPDM Materialstärke 4mm ID ø 80mm		



1

GEV-Nr.	500686	Vergl.-Nr.	1252.1401
Beschreibung	Pumpe Eingang ø 30mm Ausgang ø 30mm Typ 1252.1401 230V 50Hz Phasen 1 0,19kW 0,25PS L 180mm Laufrichtung rechts Kondensator 10µF FIR		
Ersatzteile zu	500686		
	GEV-Nr.	365015	Vergl.-Nr. —
	Betriebskondensator Kapazität 10µF 400V		

Ersatzteile zu	500686		
	GEV-Nr.	510605	Vergl.-Nr. N/A
	Laufrad ø 80mm H 21mm M7L		
	GEV-Nr.	510702	Vergl.-Nr. N/A
	Gleitringdichtung Höhe Gegenring 5,5mm		
	GEV-Nr.	521571	Vergl.-Nr. 2240303
	Pumpendeckel FIR Eingang ø 30mm Ausgang ø 30mm		
	GEV-Nr.	521701	Vergl.-Nr. N/A
	Pumpendeckeldichtung		



1

GEV-Nr.	500267	Vergl.-Nr.	1267.1400
Beschreibung	Pumpe Eingang ø 30mm Ausgang ø 30mm Typ 1267.1400 230V 50Hz Phasen 1 0,18kW 0,25PS L 185mm Laufrichtung rechts Kondensator 10µF FIR		
Ersatzteile zu	500267		
	GEV-Nr.	365015	Vergl.-Nr. —
	Betriebskondensator Kapazität 10µF 400V		
	GEV-Nr.	510605	Vergl.-Nr. N/A
	Laufrad ø 80mm H 21mm M7L		
	GEV-Nr.	510702	Vergl.-Nr. N/A
	Gleitringdichtung Höhe Gegenring 5,5mm		
	GEV-Nr.	521501	Vergl.-Nr. N/A
	Pumpendeckel Eingang ø 30mm Ausgang ø 30mm		
	GEV-Nr.	521701	Vergl.-Nr. N/A
	Pumpendeckeldichtung		



1

GEV-Nr.	500261	Vergl.-Nr.	1267.1405
Beschreibung	Pumpe Eingang ø 30mm Ausgang ø 30mm Typ 1267.1405 230V 50Hz Phasen 1 0,18kW 0,25PS L 180mm Laufrichtung rechts Kondensator 10µF FIR		
Ersatzteile zu	500261		
	GEV-Nr.	365015	Vergl.-Nr. —
	Betriebskondensator Kapazität 10µF 400V		
	GEV-Nr.	510605	Vergl.-Nr. N/A
	Laufrad ø 80mm H 21mm M7L		
	GEV-Nr.	510702	Vergl.-Nr. N/A
	Gleitringdichtung Höhe Gegenring 5,5mm		
	GEV-Nr.	521571	Vergl.-Nr. 2240303
	Pumpendeckel FIR Eingang ø 30mm Ausgang ø 30mm		
	GEV-Nr.	521701	Vergl.-Nr. N/A
	Pumpendeckeldichtung		



1

GEV-Nr.	500262	Vergl.-Nr.	1268.1401
Beschreibung	Pumpe Eingang ø 30mm Ausgang ø 30mm Typ 1268.1401 230V 50Hz Phasen 1 0,22kW 0,3PS L 185mm Laufrichtung rechts Kondensator 10µF FIR		
Ersatzteile zu	500262		
	GEV-Nr.	365015	Vergl.-Nr. —
	Betriebskondensator Kapazität 10µF 400V		
	GEV-Nr.	510609	Vergl.-Nr. N/A
	Laufrad ø 84mm H 21mm M7L		
	GEV-Nr.	510702	Vergl.-Nr. N/A
	Gleitringdichtung Höhe Gegenring 5,5mm		

Ersatzteile zu	500262		
	GEV-Nr.	521571	Vergl.-Nr. 2240303
	Pumpendeckel FIR Eingang ø 30mm Ausgang ø 30mm		
	GEV-Nr.	521701	Vergl.-Nr. N/A
	Pumpendeckeldichtung		



1

GEV-Nr.	500270	Vergl.-Nr.	1272/A
Beschreibung	Pumpe Eingang ø 30mm Ausgang ø 30mm Typ 1272 230V 50Hz Phasen 1 0,37kW 0,5PS L 195mm Laufrichtung rechts Kondensator 12,5µF FIR		
Ersatzteile zu	500270		
	GEV-Nr.	365014	Vergl.-Nr. —
	Betriebskondensator Kapazität 12,5µF 400V		
	GEV-Nr.	510605	Vergl.-Nr. N/A
	Laufrad ø 80mm H 21mm M7L		
	GEV-Nr.	510702	Vergl.-Nr. N/A
	Gleitringdichtung Höhe Gegenring 5,5mm		
	GEV-Nr.	521571	Vergl.-Nr. 2240303
	Pumpendeckel FIR Eingang ø 30mm Ausgang ø 30mm		
	GEV-Nr.	521701	Vergl.-Nr. N/A
	Pumpendeckeldichtung		



1

GEV-Nr.	500268	Vergl.-Nr.	1272/A
Beschreibung	Pumpe Eingang ø 30mm Ausgang ø 30mm Typ 1272/A 230V 50Hz Phasen 1 0,37kW 0,5PS L 195mm Laufrichtung rechts Kondensator 12,5µF FIR		
Ersatzteile zu	500268		
	GEV-Nr.	365014	Vergl.-Nr. —
	Betriebskondensator Kapazität 12,5µF 400V		
	GEV-Nr.	510605	Vergl.-Nr. N/A
	Laufrad ø 80mm H 21mm M7L		
	GEV-Nr.	510702	Vergl.-Nr. N/A
	Gleitringdichtung Höhe Gegenring 5,5mm		
	GEV-Nr.	521501	Vergl.-Nr. N/A
	Pumpendeckel Eingang ø 30mm Ausgang ø 30mm		
	GEV-Nr.	521701	Vergl.-Nr. N/A
	Pumpendeckeldichtung		



1

GEV-Nr.	499171	Vergl.-Nr.	2240.1411
Beschreibung	Pumpe Eingang ø 30mm Ausgang ø 30mm Typ 2240.1411 230V 50Hz Phasen 1 0,24kW 0,33PS L 183mm Laufrichtung rechts Kondensator 10µF FIR		
Ersatzteile zu	499171		
	GEV-Nr.	365015	Vergl.-Nr. —
	Betriebskondensator Kapazität 10µF 400V		
	GEV-Nr.	510607	Vergl.-Nr. N/A
	Laufrad ø 85mm H 29mm Achsaufnahme ø 9x8mm		
	GEV-Nr.	510695	Vergl.-Nr. N/A
	Gleitringdichtung Höhe Gegenring 5,5mm		
	GEV-Nr.	521571	Vergl.-Nr. 2240303
	Pumpendeckel FIR Eingang ø 30mm Ausgang ø 30mm		
	GEV-Nr.	521701	Vergl.-Nr. N/A
	Pumpendeckeldichtung		
	GEV-Nr.	521707	Vergl.-Nr. N/A
	Pumpendeckeldichtung		



1

GEV-Nr.	500383	Vergl.-Nr.	1286.1406
Beschreibung	Pumpe Eingang ø 30mm Ausgang ø 30mm Typ 1286.1406 230V 50Hz Phasen 1 0,18kW 0,25PS Laufrichtung rechts FIR		



1

GEV-Nr.	499105	Vergl.-Nr.	2286D1405
Beschreibung	Pumpe Eingang ø 30mm Ausgang ø 30mm Typ 2286D1405 220/240V 50Hz Phasen 1 0,18kW 0,25PS L 180mm Laufrichtung rechts Kondensator 10µF FIR		
Ersatzteile zu	499105		
	GEV-Nr.	365015	Vergl.-Nr. —
	Betriebskondensator Kapazität 10µF 400V		
	GEV-Nr.	510605	Vergl.-Nr. N/A
	Laufrad ø 80mm H 21mm M7L		
	GEV-Nr.	510702	Vergl.-Nr. N/A
	Gleitringdichtung Höhe Gegenring 5,5mm		
	GEV-Nr.	521571	Vergl.-Nr. 2240303
	Pumpendeckel FIR Eingang ø 30mm Ausgang ø 30mm		
	GEV-Nr.	521701	Vergl.-Nr. N/A
	Pumpendeckeldichtung		



1

GEV-Nr.	500331	Vergl.-Nr.	B286.1650
Beschreibung	Pumpe Eingang ø 30mm Ausgang ø 30mm Typ B286.1650 230V 50Hz Phasen 1 0,37kW 0,5PS L 195mm Laufrichtung rechts Kondensator 12,5µF FIR		
Ersatzteile zu	500331		
	GEV-Nr.	365014	Vergl.-Nr. —
	Betriebskondensator Kapazität 12,5µF 400V		

Ersatzteile zu	500331		
	GEV-Nr.	510607	Vergl.-Nr. N/A
	Laufrad ø 85mm H 29mm Achsaufnahme ø 9x8mm		
	GEV-Nr.	510695	Vergl.-Nr. N/A
	Gleitringdichtung Höhe Gegenring 5,5mm		
	GEV-Nr.	521571	Vergl.-Nr. 2240303
	Pumpendeckel FIR Eingang ø 30mm Ausgang ø 30mm		
	GEV-Nr.	521701	Vergl.-Nr. N/A
	Pumpendeckeldichtung		
	GEV-Nr.	521707	Vergl.-Nr. N/A
	Pumpendeckeldichtung		



1

GEV-Nr.	500327	Vergl.-Nr.	B287.1650
Beschreibung	Pumpe Eingang ø 30mm Ausgang ø 30mm Typ B287.1650 230V 50Hz Phasen 1 0,24kW 0,33PS L 180mm Laufrichtung rechts Kondensator 10µF FIR		
Ersatzteile zu	500327		
	GEV-Nr.	365015	Vergl.-Nr. —
	Betriebskondensator Kapazität 10µF 400V		
	GEV-Nr.	510607	Vergl.-Nr. N/A
	Laufrad ø 85mm H 29mm Achsaufnahme ø 9x8mm		
	GEV-Nr.	510695	Vergl.-Nr. N/A
	Gleitringdichtung Höhe Gegenring 5,5mm		
	GEV-Nr.	521571	Vergl.-Nr. 2240303
	Pumpendeckel FIR Eingang ø 30mm Ausgang ø 30mm		
	GEV-Nr.	521701	Vergl.-Nr. N/A
	Pumpendeckeldichtung		
	GEV-Nr.	521707	Vergl.-Nr. N/A
	Pumpendeckeldichtung		



1

GEV-Nr.	499327	Vergl.-Nr.	5215.4150
Beschreibung	Pumpe Eingang ø 30mm Ausgang ø 35mm Typ 5215.4150 200-254/346-440VV 50Hz Phasen 3		
Ersatzteile zu	499327		
	GEV-Nr.	521079	Vergl.-Nr. —
	Lüfterradabdeckung ø 155mm H 70mm Kunststoff		





1

GEV-Nr.	499321	Vergl.-Nr.	B242C2702
Beschreibung	Pumpe Eingang ø 30mm Ausgang ø 35mm Typ B242C2702 230V 50Hz Phasen 3 0,55kW L 300mm Laufrichtung rechts FIR		





1

GEV-Nr.	500020	Vergl.-Nr.	4134.1402
Beschreibung	Pumpe Eingang ø 32mm Ausgang ø 32mm Typ 4134.1402 230V 50Hz Phasen 1 0,18kW 0,25PS L 180mm Laufrichtung rechts Kondensator 10µF FIR		
Ersatzteile zu	500020		
	GEV-Nr.	510506	Vergl.-Nr. —
	Pumpendeckel Pumpentyp 4333/1265		
Zubehör zu	500020		
	GEV-Nr.	504329	Vergl.-Nr. —
	Blindstopfen H 17,5mm Gewinde M16x1,5 Kunststoff		



1

GEV-Nr.	500558	Vergl.-Nr.	B226H1500
Beschreibung	Pumpe Eingang ø 33mm Ausgang ø 30/28mm Typ B266H1500 230V 50Hz Phasen 1 0,22kW 0,3PS L 195mm Laufrichtung rechts Kondensator 5µF FIR		
Ersatzteile zu	500558		
	GEV-Nr.	365017	Vergl.-Nr. —
	Betriebskondensator Kapazität 5µF 450V		
	GEV-Nr.	510693	Vergl.-Nr. N/A
	Gleitringdichtung für Wellen ø 12mm		
	GEV-Nr.	521545	Vergl.-Nr. N/A
	Pumpendeckel FIR Typ B226H Eingang ø 33mm		

Tabellenfortsetzung auf der nächsten Seite

Ersatzteile zu	500558			
Bild nicht vorhanden	GEV-Nr.	521565	Vergl.-Nr.	N/A
	Pumpendeckeldichtung Pumpentyp B226H			
	GEV-Nr.	521566	Vergl.-Nr.	N/A
	Laufrad ø 80mm H 15mm M7L Pumpentyp B226H			



GEV-Nr.	500561	Vergl.-Nr.	B221A	
Beschreibung	Pumpe Eingang ø 33mm Ausgang ø 30mm Typ B221A 230V 50Hz Phasen 1 0,15kW 0,2PS L 195mm Laufrichtung links Kondensator 6,3µF FIR			
Ersatzteile zu	500561			
	GEV-Nr.	365012	Vergl.-Nr.	—
	Betriebskondensator Kapazität 6,3µF 450V			
	GEV-Nr.	501309	Vergl.-Nr.	N/A
	Laufrad ø 80mm H 19mm M7R Pumpentyp Typ D1			
	GEV-Nr.	501310	Vergl.-Nr.	—
	Pumpendeckel			
	GEV-Nr.	510693	Vergl.-Nr.	N/A
	Gleitringdichtung für Wellen ø 12mm			





GEV-Nr.	500274	Vergl.-Nr.	B221A1500	
Beschreibung	Pumpe Eingang ø 33mm Ausgang ø 30mm Typ B221A1500 230V 50Hz Phasen 1 0,15kW 0,2PS L 195mm Laufrichtung links Kondensator 6,3µF FIR			
Ersatzteile zu	500274			
	GEV-Nr.	365012	Vergl.-Nr.	—
	Betriebskondensator Kapazität 6,3µF 450V			
	GEV-Nr.	501309	Vergl.-Nr.	N/A
	Laufrad ø 80mm H 19mm M7R Pumpentyp Typ D1			
	GEV-Nr.	510693	Vergl.-Nr.	N/A
	Gleitringdichtung für Wellen ø 12mm			
Bild nicht vorhanden	GEV-Nr.	521500	Vergl.-Nr.	N/A
	Pumpendeckel			
	GEV-Nr.	521700	Vergl.-Nr.	N/A
	Pumpendeckeldichtung			
	GEV-Nr.	551223	Vergl.-Nr.	—
	Gehäuse 4-polig Größe 6,3mm gerade Nylon			



GEV-Nr.	500388	Vergl.-Nr.	B265.1500	
Beschreibung	Pumpe Eingang ø 33mm Ausgang ø 30mm Typ B265.1500 230V 50Hz Phasen 1 0,22kW 0,3PS L 265mm Laufrichtung links Kondensator 6,3µF FIR			
Ersatzteile zu	500388			
	GEV-Nr.	365012	Vergl.-Nr.	—
	Betriebskondensator Kapazität 6,3µF 450V			

Tabellenfortsetzung auf der nächsten Seite



Ersatzteile zu 500388			
	GEV-Nr.	501309	Vergl.-Nr. N/A
Laufrad ø 80mm H 19mm M7R Pumpentyp Typ D1			
	GEV-Nr.	510702	Vergl.-Nr. N/A
Gleitringdichtung Höhe Gegenring 5,5mm			
Bild nicht vorhanden	GEV-Nr.	521500	Vergl.-Nr. N/A
Pumpendeckel			
	GEV-Nr.	521700	Vergl.-Nr. N/A
Pumpendeckeldichtung			



1

GEV-Nr.	500127	Vergl.-Nr.	4247.1900
Beschreibung	Pumpe Eingang ø 37mm Ausgang ø 41mm Typ 4247.1900 230V 50Hz Phasen 1 0,44kW 0,6PS L 200mm Laufrichtung rechts Kondensator 10µF FIR		
Ersatzteile zu 500127			
	GEV-Nr.	365015	Vergl.-Nr. —
Betriebskondensator Kapazität 10µF 400V			
	GEV-Nr.	510608	Vergl.-Nr. N/A
Laufrad ø 93mm H 32mm Achsaufnahme ø 9/8mm			
	GEV-Nr.	510692	Vergl.-Nr. N/A
Gleitringdichtung für Wellen ø 11mm			
	GEV-Nr.	521505	Vergl.-Nr. X4247-HP,0,6_(1)
Pumpendeckel FIR Eingang ø 37mm Ausgang ø 40mm			
	GEV-Nr.	521702	Vergl.-Nr. N/A
Pumpendeckeldichtung Materialstärke 3,5x4,5mm			



1

GEV-Nr.	499170	Vergl.-Nr.	4243.1400
Beschreibung	Pumpe Eingang ø 45mm Ausgang ø 1" IG Typ 4243.1400 230V Phasen 1 0,55kW 0,75PS L 310mm Laufrichtung rechts Kondensator 12,5µF FIR		



1

GEV-Nr.	500463	Vergl.-Nr.	2253
Beschreibung	Pumpe Eingang ø 45mm Ausgang ø 30mm Typ 2253 230V 50Hz Phasen 1 0,24kW 0,33PS L 160mm Laufrichtung rechts FIR		
Ersatzteile zu 500463			
Bild nicht vorhanden	GEV-Nr.	521148	Vergl.-Nr. —
Pumpendeckel Pumpentyp Fir 2253(500.463)			



1

GEV-Nr.	500125	Vergl.-Nr.	2253
Beschreibung	Pumpe Eingang ø 45mm Ausgang ø 30mm Typ 2253 230V 50Hz Phasen 1 0,24kW 0,33PS L 175mm Laufrichtung rechts Kondensator 10µF FIR Eingang ø 45mm Ausgang ø 30mm		



1

GEV-Nr.	501464	Vergl.-Nr.	3910.1423
Beschreibung	Pumpe Eingang ø 45mm Ausgang ø 39mm Typ 3910.1423 230V 50Hz Phasen 1 0,4kW L 220mm Laufrichtung rechts Kondensator 10µF FIR		



1

GEV-Nr.	499165	Vergl.-Nr.	1297.1900	
Beschreibung	Pumpe Eingang ø 45mm Ausgang ø 32mm Typ 1297.1900 230V 50Hz Phasen 1 0,29kW 0,4PS L 165mm Laufrichtung rechts Kondensator 8µF FIR			
Ersatzteile zu	499165			
	GEV-Nr.	365013	Vergl.-Nr.	—
	Betriebskondensator Kapazität 8µF 400V			
	GEV-Nr.	510512	Vergl.-Nr.	—
	Pumpendeckel OLYMPIA Eingang ø 45mm Ausgang ø 31mm			
	GEV-Nr.	510554	Vergl.-Nr.	—
	O-Ring EPDM Materialstärke 2mm ID ø 120mm			
	GEV-Nr.	510615	Vergl.-Nr.	—
	Laufrad ø 90mm H 22mm Laufrichtung rechts			
	GEV-Nr.	510693	Vergl.-Nr.	N/A
	Gleitringdichtung für Wellen ø 12mm			

Ersatzteile zu	501464			
	GEV-Nr.	365015	Vergl.-Nr.	—
	Betriebskondensator Kapazität 10µF 400V			
	GEV-Nr.	510508	Vergl.-Nr.	N/A
	Pumpendeckel FIR Eingang ø 45mm Ausgang ø 40mm			
	GEV-Nr.	510607	Vergl.-Nr.	N/A
	Laufrad ø 85mm H 29mm Achsaufnahme ø 9x8mm			
	GEV-Nr.	510692	Vergl.-Nr.	N/A
	Gleitringdichtung für Wellen ø 11mm			
	GEV-Nr.	521702	Vergl.-Nr.	N/A
	Pumpendeckeldichtung Materialstärke 3,5x4,5mm			



1

GEV-Nr.	500710	Vergl.-Nr.	1217/A
Beschreibung	Pumpe Eingang ø 45mm Ausgang ø 40mm Typ 1217/A 230V 50Hz Phasen 1 0,56kW 0,75PS L 295mm Laufrichtung rechts Kondensator 12,5µF FIR		





1

GEV-Nr.	500017	Vergl.-Nr.	1219.1405
Beschreibung	Pumpe Eingang ø 45mm Ausgang ø 40mm Typ 1219.1405 230V 50Hz Phasen 1 0,73kW 1PS L 300mm Laufrichtung rechts Kondensator 12,5µF FIR		
Ersatzteile zu	500017		
	GEV-Nr.	365014	Vergl.-Nr. —
	Betriebskondensator Kapazität 12,5µF 400V		
	GEV-Nr.	510600	Vergl.-Nr. N/A
	Laufrad ø 102mm H 29mm Achsaufnahme ø 9/8mm		
	GEV-Nr.	510692	Vergl.-Nr. N/A
	Gleitringdichtung für Wellen ø 11mm		
	GEV-Nr.	521539	Vergl.-Nr. N/A
	Pumpendeckel FIR Eingang ø 45mm Ausgang ø 40mm		
	GEV-Nr.	521702	Vergl.-Nr. N/A
	Pumpendeckeldichtung Materialstärke 3,5x4,5mm		



1

GEV-Nr.	499140	Vergl.-Nr.	1219.2504
Beschreibung	Pumpe Eingang ø 45mm Ausgang ø 40mm Typ 1219.2504 220/380-240/415V 50Hz Phasen 3 1,1kW 1,5PS L 290mm Laufrichtung rechts FIR		
Ersatzteile zu	499140		
	GEV-Nr.	502007	Vergl.-Nr. N/A
	Pumpendeckeldichtung		

Ersatzteile zu	499140		
	GEV-Nr.	510529	Vergl.-Nr. N/A
	Laufrad ø 103mm H 30mm Achsaufnahme ø 9/8mm		
	GEV-Nr.	510692	Vergl.-Nr. N/A
	Gleitringdichtung für Wellen ø 11mm		
	GEV-Nr.	511187	Vergl.-Nr. N/A
	Pumpendeckel FIR Eingang ø 45mm Ausgang ø 40mm		



1

GEV-Nr.	500004	Vergl.-Nr.	1219.2521
Beschreibung	Pumpe Eingang ø 45mm Ausgang ø 40mm Typ 1219.2521 230/400V 50Hz Phasen 3 1,1kW 1,5PS L 300mm Laufrichtung rechts Kondensator µF FIR		
Ersatzteile zu	500004		
	GEV-Nr.	502007	Vergl.-Nr. N/A
	Pumpendeckeldichtung		
	GEV-Nr.	510529	Vergl.-Nr. N/A
	Laufrad ø 103mm H 30mm Achsaufnahme ø 9/8mm		
	GEV-Nr.	510692	Vergl.-Nr. N/A
	Gleitringdichtung für Wellen ø 11mm		
	GEV-Nr.	511187	Vergl.-Nr. N/A
	Pumpendeckel FIR Eingang ø 45mm Ausgang ø 40mm		



1

GEV-Nr.	500033	Vergl.-Nr.	1221.1400
Beschreibung	Pumpe Eingang ø 45mm Ausgang ø 40mm Typ 1221.1400 230V 50Hz Phasen 1 0,37kW 0,5PS L 210mm Laufrichtung rechts Kondensator 12,5µF FIR		
Ersatzteile zu	500033		
	GEV-Nr.	365014	Vergl.-Nr. —
	Betriebskondensator Kapazität 12,5µF 400V		
	GEV-Nr.	502007	Vergl.-Nr. N/A
	Pumpendeckeldichtung		
	GEV-Nr.	510607	Vergl.-Nr. N/A
	Laufrad ø 85mm H 29mm Achsaufnahme ø 9x8mm		
	GEV-Nr.	510692	Vergl.-Nr. N/A
	Gleitringdichtung für Wellen ø 11mm		
	GEV-Nr.	511187	Vergl.-Nr. N/A
	Pumpendeckel FIR Eingang ø 45mm Ausgang ø 40mm		



1

GEV-Nr.	500009	Vergl.-Nr.	1222.1406
Beschreibung	Pumpe Eingang ø 45mm Ausgang ø 40mm Typ 1222.1406 230V 50Hz Phasen 1 0,37kW 0,5PS L 275mm Laufrichtung rechts Kondensator 12,5µF FIR		
Ersatzteile zu	500009		
	GEV-Nr.	365014	Vergl.-Nr. —
	Betriebskondensator Kapazität 12,5µF 400V		
	GEV-Nr.	502007	Vergl.-Nr. N/A
	Pumpendeckeldichtung		

Ersatzteile zu	500009		
	GEV-Nr.	510607	Vergl.-Nr. N/A
	Laufrad ø 85mm H 29mm Achsaufnahme ø 9x8mm		
	GEV-Nr.	510692	Vergl.-Nr. N/A
	Gleitringdichtung für Wellen ø 11mm		
	GEV-Nr.	511187	Vergl.-Nr. N/A
	Pumpendeckel FIR Eingang ø 45mm Ausgang ø 40mm		



1

GEV-Nr.	499071	Vergl.-Nr.	1222.2800
Beschreibung	Pumpe Eingang ø 45mm Ausgang ø 40mm Typ 1222.2800 440V 60Hz 0,37kW 0,5PS L 275mm Laufrichtung rechts FIR		
Ersatzteile zu	499071		
	GEV-Nr.	502007	Vergl.-Nr. N/A
	Pumpendeckeldichtung		
	GEV-Nr.	510528	Vergl.-Nr. —
	Flansch passend für Pumpe		
	GEV-Nr.	510692	Vergl.-Nr. N/A
	Gleitringdichtung für Wellen ø 11mm		
	GEV-Nr.	511187	Vergl.-Nr. N/A
	Pumpendeckel FIR Eingang ø 45mm Ausgang ø 40mm		



1

GEV-Nr.	500086	Vergl.-Nr.	1223.1400
Beschreibung	Pumpe Eingang ø 45mm Ausgang ø 40mm Typ 1223.1400 230V 50Hz Phasen 1 0,55kW 0,75PS L 275mm Laufrichtung rechts Kondensator 12,5µF FIR		
Ersatzteile zu	500086		
	GEV-Nr.	365014	Vergl.-Nr. —
	Betriebskondensator Kapazität 12,5µF 400V		
	GEV-Nr.	502007	Vergl.-Nr. N/A
	Pumpendeckeldichtung		
	GEV-Nr.	510608	Vergl.-Nr. N/A
	Laufrad ø 93mm H 32mm Achsaufnahme ø 9/8mm		
	GEV-Nr.	510692	Vergl.-Nr. N/A
	Gleitringdichtung für Wellen ø 11mm		
	GEV-Nr.	511187	Vergl.-Nr. N/A
	Pumpendeckel FIR Eingang ø 45mm Ausgang ø 40mm		
	GEV-Nr.	521022	Vergl.-Nr. —
	Lüfterradabdeckung ID ø 137mm AD ø 142mm H 70mm		



1





GEV-Nr.	500254	Vergl.-Nr.	1266.1400
Beschreibung	Pumpe Eingang ø 45mm Ausgang ø 40mm Typ 1266.1400 230V 50Hz Phasen 1 0,37kW 0,5PS L 205mm Laufrichtung rechts Kondensator 12,5µF FIR		
Ersatzteile zu	500254		
	GEV-Nr.	365014	Vergl.-Nr. —
	Betriebskondensator Kapazität 12,5µF 400V		
	GEV-Nr.	510508	Vergl.-Nr. N/A
	Pumpendeckel FIR Eingang ø 45mm Ausgang ø 40mm		
	GEV-Nr.	510692	Vergl.-Nr. N/A
	Gleitringdichtung für Wellen ø 11mm		
	GEV-Nr.	521210	Vergl.-Nr. N/A
	Laufrad ø 96mm H 30mm Achsaufnahme ø 9/8mm		
	GEV-Nr.	521702	Vergl.-Nr. N/A
	Pumpendeckeldichtung Materialstärke 3,5x4,5mm		



1

GEV-Nr.	500256	Vergl.-Nr.	1270/A
Beschreibung	Pumpe Eingang ø 45mm Ausgang ø 40mm Typ 1270 230V 50Hz Phasen 1 0,55kW 0,75PS L 205mm Laufrichtung rechts Kondensator 12,5µF FIR		
Ersatzteile zu	500256		
	GEV-Nr.	365014	Vergl.-Nr. —
	Betriebskondensator Kapazität 12,5µF 400V		

Tabellenfortsetzung auf der nächsten Seite

Ersatzteile zu	500256		
	GEV-Nr.	510508	Vergl.-Nr. N/A
Pumpendeckel FIR Eingang ø 45mm Ausgang ø 40mm			
	GEV-Nr.	510692	Vergl.-Nr. N/A
Gleitringdichtung für Wellen ø 11mm			
	GEV-Nr.	521210	Vergl.-Nr. N/A
Laufrad ø 96mm H 30mm Achsaufnahme ø 9/8mm			
	GEV-Nr.	521702	Vergl.-Nr. N/A
Pumpendeckeldichtung Materialstärke 3,5x4,5mm			





GEV-Nr.	500252	Vergl.-Nr.	1270.1402
Beschreibung	Pumpe Eingang ø 45mm Ausgang ø 40mm Typ 1270/A 230V 50Hz Phasen 1 0,55kW 0,75PS L 205mm Laufrichtung rechts Kondensator 12,5µF FIR		
Ersatzteile zu	500252		
	GEV-Nr.	365014	Vergl.-Nr. —
Betriebskondensator Kapazität 12,5µF 400V			
	GEV-Nr.	510508	Vergl.-Nr. N/A
Pumpendeckel FIR Eingang ø 45mm Ausgang ø 40mm			
	GEV-Nr.	510692	Vergl.-Nr. N/A
Gleitringdichtung für Wellen ø 11mm			
	GEV-Nr.	521210	Vergl.-Nr. N/A
Laufrad ø 96mm H 30mm Achsaufnahme ø 9/8mm			
	GEV-Nr.	521702	Vergl.-Nr. N/A
Pumpendeckeldichtung Materialstärke 3,5x4,5mm			





GEV-Nr.	500289	Vergl.-Nr.	1276.2530
Beschreibung	Pumpe Eingang ø 45mm Ausgang ø 40mm Typ 1276.2530 230/400V 50Hz Phasen 3 0,55kW 0,75PS L 270mm Laufrichtung rechts FIR		
Ersatzteile zu	500289		
	GEV-Nr.	501314	Vergl.-Nr. N/A
Laufrad ø 75mm			
	GEV-Nr.	502007	Vergl.-Nr. N/A
Pumpendeckeldichtung			
	GEV-Nr.	502014	Vergl.-Nr. N/A
Pumpendeckel FIR Eingang ø 45mm Ausgang ø 40mm			
	GEV-Nr.	510692	Vergl.-Nr. N/A
Gleitringdichtung für Wellen ø 11mm			



GEV-Nr.	500707	Vergl.-Nr.	1278.1401
Beschreibung	Pumpe Eingang ø 45mm Ausgang ø 40mm Typ 1278.1401 230V 50Hz Phasen 1 0,75kW 1PS L 210mm Laufrichtung rechts Kondensator 12,5µF FIR		
Ersatzteile zu	500707		
	GEV-Nr.	365014	Vergl.-Nr. —
Betriebskondensator Kapazität 12,5µF 400V			
	GEV-Nr.	510508	Vergl.-Nr. N/A
Pumpendeckel FIR Eingang ø 45mm Ausgang ø 40mm			

Tabellenfortsetzung auf der nächsten Seite



Ersatzteile zu 500707			
	GEV-Nr.	510610	Vergl.-Nr. N/A
Laufrad ø 95,5mm H 23mm Achsaufnahme ø 9/8mm			
	GEV-Nr.	510692	Vergl.-Nr. N/A
Gleitringdichtung für Wellen ø 11mm			
	GEV-Nr.	521702	Vergl.-Nr. N/A
Pumpendeckeldichtung Materialstärke 3,5x4,5mm			



1			
GEV-Nr.	500027	Vergl.-Nr.	1292.1400
Beschreibung	Pumpe Eingang ø 45mm Ausgang ø 40mm Typ 1292.1400 230V 50Hz Phasen 1 0,56kW 0,75PS L 200mm Laufrichtung rechts Kondensator 12,5µF FIR		
Ersatzteile zu 500027			
	GEV-Nr.	365014	Vergl.-Nr. —
Betriebskondensator Kapazität 12,5µF 400V			
	GEV-Nr.	510600	Vergl.-Nr. N/A
Laufrad ø 102mm H 29mm Achsaufnahme ø 9/8mm			
	GEV-Nr.	510692	Vergl.-Nr. N/A
Gleitringdichtung für Wellen ø 11mm			
	GEV-Nr.	521506	Vergl.-Nr. N/A
Pumpendeckel FIR Eingang ø 45mm Ausgang ø 40mm			
	GEV-Nr.	521702	Vergl.-Nr. N/A
Pumpendeckeldichtung Materialstärke 3,5x4,5mm			



1			
GEV-Nr.	500684	Vergl.-Nr.	1299.1402
Beschreibung	Pumpe Eingang ø 45mm Ausgang ø 40mm Typ 1299.1402 230V 50Hz Phasen 1 0,37kW 0,5PS L 208mm Laufrichtung rechts Kondensator 12,5µF FIR		
Ersatzteile zu 500684			
	GEV-Nr.	365014	Vergl.-Nr. —
Betriebskondensator Kapazität 12,5µF 400V			
	GEV-Nr.	510508	Vergl.-Nr. N/A
Pumpendeckel FIR Eingang ø 45mm Ausgang ø 40mm			
	GEV-Nr.	510607	Vergl.-Nr. N/A
Laufrad ø 85mm H 29mm Achsaufnahme ø 9x8mm			
	GEV-Nr.	510692	Vergl.-Nr. N/A
Gleitringdichtung für Wellen ø 11mm			
	GEV-Nr.	521702	Vergl.-Nr. N/A
Pumpendeckeldichtung Materialstärke 3,5x4,5mm			



1			
GEV-Nr.	500549	Vergl.-Nr.	2220
Beschreibung	Pumpe Eingang ø 45mm Ausgang ø 40mm Typ 2220 230V 50Hz Phasen 1 0,73kW 1PS L 235mm Laufrichtung rechts Kondensator 16µF FIR		
Ersatzteile zu 500549			
	GEV-Nr.	365021	Vergl.-Nr. —
Betriebskondensator Kapazität 16µF 425V			

Tabellenfortsetzung auf der nächsten Seite

Ersatzteile zu 500549				
	GEV-Nr.	502007	Vergl.-Nr.	N/A
Pumpendeckeldichtung				
	GEV-Nr.	502014	Vergl.-Nr.	N/A
Pumpendeckel FIR Eingang ø 45mm Ausgang ø 40mm				
	GEV-Nr.	510529	Vergl.-Nr.	N/A
Laufgrad ø 103mm H 30mm Achsaufnahme ø 9/8mm				
	GEV-Nr.	510692	Vergl.-Nr.	N/A
Gleitringdichtung für Wellen ø 11mm				



GEV-Nr.	500118	Vergl.-Nr.	2236.1400	
Beschreibung	Pumpe Eingang ø 45mm Ausgang ø 40mm Typ 2236.1400 230V 50Hz Phasen 1 0,74kW 1PS L 235mm Laufrichtung rechts Kondensator 16µF FIR			
Ersatzteile zu 500118				
	GEV-Nr.	365021	Vergl.-Nr.	—
Betriebskondensator Kapazität 16µF 425V				
	GEV-Nr.	510508	Vergl.-Nr.	N/A
Pumpendeckel FIR Eingang ø 45mm Ausgang ø 40mm				
	GEV-Nr.	510600	Vergl.-Nr.	N/A
Laufgrad ø 102mm H 29mm Achsaufnahme ø 9/8mm				
	GEV-Nr.	510692	Vergl.-Nr.	N/A
Gleitringdichtung für Wellen ø 11mm				
	GEV-Nr.	521702	Vergl.-Nr.	N/A
Pumpendeckeldichtung Materialstärke 3,5x4,5mm				



GEV-Nr.	500702	Vergl.-Nr.	2246.1400	
Beschreibung	Pumpe Eingang ø 45mm Ausgang ø 40mm Typ 2246.1400 230V 50Hz Phasen 1 0,24kW 0,33PS L 195mm Laufrichtung rechts Kondensator 10µF FIR			
Ersatzteile zu 500702				
	GEV-Nr.	365015	Vergl.-Nr.	—
Betriebskondensator Kapazität 10µF 400V				
	GEV-Nr.	510607	Vergl.-Nr.	N/A
Laufgrad ø 85mm H 29mm Achsaufnahme ø 9x8mm				
	GEV-Nr.	510692	Vergl.-Nr.	N/A
Gleitringdichtung für Wellen ø 11mm				
	GEV-Nr.	521539	Vergl.-Nr.	N/A
Pumpendeckel FIR Eingang ø 45mm Ausgang ø 40mm				
	GEV-Nr.	521702	Vergl.-Nr.	N/A
Pumpendeckeldichtung Materialstärke 3,5x4,5mm				



GEV-Nr.	500287	Vergl.-Nr.	2256.1420	
Beschreibung	Pumpe Eingang ø 45mm Ausgang ø 40mm Typ 2256.1420 230V 50Hz Phasen 1 0,73kW 1PS L 200mm Laufrichtung rechts Kondensator 16µF FIR			
Ersatzteile zu 500287				
	GEV-Nr.	365021	Vergl.-Nr.	—
Betriebskondensator Kapazität 16µF 425V				

Tabellenfortsetzung auf der nächsten Seite



Ersatzteile zu 500287			
	GEV-Nr.	501313	Vergl.-Nr. N/A
Laufrad ø 103mm H 28mm Achsaufnahme ø 9/8mm			
	GEV-Nr.	502007	Vergl.-Nr. N/A
Pumpendeckeldichtung			
	GEV-Nr.	502014	Vergl.-Nr. N/A
Pumpendeckel FIR Eingang ø 45mm Ausgang ø 40mm			
	GEV-Nr.	510692	Vergl.-Nr. N/A
Gleitringdichtung für Wellen ø 11mm			



GEV-Nr.	499216	Vergl.-Nr.	2256T2550
Beschreibung	Pumpe Eingang ø 45mm Ausgang ø 40mm Typ 2256T2550 180-253V 50Hz Phasen 1 0,75kW 1PS L 250mm Laufrichtung rechts Kondensator 20µF FIR		
Ersatzteile zu 499216			
	GEV-Nr.	365019	Vergl.-Nr. —
Betriebskondensator Kapazität 20µF 400V			
	GEV-Nr.	501313	Vergl.-Nr. N/A
Laufrad ø 103mm H 28mm Achsaufnahme ø 9/8mm			
	GEV-Nr.	502007	Vergl.-Nr. N/A
Pumpendeckeldichtung			
	GEV-Nr.	502014	Vergl.-Nr. N/A
Pumpendeckel FIR Eingang ø 45mm Ausgang ø 40mm			
	GEV-Nr.	510692	Vergl.-Nr. N/A
Gleitringdichtung für Wellen ø 11mm			



GEV-Nr.	499069	Vergl.-Nr.	2256V1425
Beschreibung	Pumpe Eingang ø 45mm Ausgang ø 40mm Typ 2256V1425 230V 50Hz Phasen 1 0,74kW 1PS L 235mm Laufrichtung rechts Kondensator 16µF FIR		
Ersatzteile zu 499069			
	GEV-Nr.	365021	Vergl.-Nr. —
Betriebskondensator Kapazität 16µF 425V			
	GEV-Nr.	499188	Vergl.-Nr. 2256V1425
Pumpe Eingang ø 45mm Ausgang ø 40mm Typ 2256V1425			
	GEV-Nr.	510529	Vergl.-Nr. N/A
Laufrad ø 103mm H 30mm Achsaufnahme ø 9/8mm			
	GEV-Nr.	510692	Vergl.-Nr. N/A
Gleitringdichtung für Wellen ø 11mm			
	GEV-Nr.	521539	Vergl.-Nr. N/A
Pumpendeckel FIR Eingang ø 45mm Ausgang ø 40mm			
	GEV-Nr.	521702	Vergl.-Nr. N/A
Pumpendeckeldichtung Materialstärke 3,5x4,5mm			









GEV-Nr.	499188	Vergl.-Nr.	2256V1425
Beschreibung	Pumpe Eingang ø 45mm Ausgang ø 40mm Typ 2256V1425 230V 50Hz Phasen 1 0,75kW 1PS L 235mm Laufrichtung rechts Kondensator 16µF FIR		
Ersatzteile zu 499188			
	GEV-Nr.	365021	Vergl.-Nr. —
Betriebskondensator Kapazität 16µF 425V			

Tabellenfortsetzung auf der nächsten Seite

Ersatzteile zu 499188			
	GEV-Nr.	499188	Vergl.-Nr. 2256V1425
Pumpe Eingang ø 45mm Ausgang ø 40mm Typ 2256V1425			
	GEV-Nr.	510529	Vergl.-Nr. N/A
Laufrad ø 103mm H 30mm Achsaufnahme ø 9/8mm			
	GEV-Nr.	510692	Vergl.-Nr. N/A
Gleitringdichtung für Wellen ø 11mm			
	GEV-Nr.	521539	Vergl.-Nr. N/A
Pumpendeckel FIR Eingang ø 45mm Ausgang ø 40mm			
	GEV-Nr.	521702	Vergl.-Nr. N/A
Pumpendeckeldichtung Materialstärke 3,5x4,5mm			



1

GEV-Nr.	500269	Vergl.-Nr.	2265.1920
Beschreibung	Pumpe Eingang ø 45mm Ausgang ø 40mm Typ 2265.1920 230V 50Hz Phasen 1 0,55kW 0,75PS L 245mm Laufrichtung rechts Kondensator 16µF FIR		
Ersatzteile zu 500269			
	GEV-Nr.	365021	Vergl.-Nr. —
Betriebskondensator Kapazität 16µF 425V			
	GEV-Nr.	510508	Vergl.-Nr. N/A
Pumpendeckel FIR Eingang ø 45mm Ausgang ø 40mm			
	GEV-Nr.	510600	Vergl.-Nr. N/A
Laufrad ø 102mm H 29mm Achsaufnahme ø 9/8mm			
	GEV-Nr.	510692	Vergl.-Nr. N/A
Gleitringdichtung für Wellen ø 11mm			
	GEV-Nr.	521023	Vergl.-Nr. —
Lüfterradabdeckung AD ø 150mm H 70mm			
	GEV-Nr.	521702	Vergl.-Nr. N/A
Pumpendeckeldichtung Materialstärke 3,5x4,5mm			



1

GEV-Nr.	500263	Vergl.-Nr.	2265.1921
Beschreibung	Pumpe Eingang ø 45mm Ausgang ø 40mm Typ 2265.1921 230V 50Hz Phasen 1 0,55kW 0,75PS L 250mm Laufrichtung rechts Kondensator 16µF FIR		
Ersatzteile zu 500263			
	GEV-Nr.	365021	Vergl.-Nr. —
Betriebskondensator Kapazität 16µF 425V			
	GEV-Nr.	510508	Vergl.-Nr. N/A
Pumpendeckel FIR Eingang ø 45mm Ausgang ø 40mm			
	GEV-Nr.	510600	Vergl.-Nr. N/A
Laufrad ø 102mm H 29mm Achsaufnahme ø 9/8mm			
	GEV-Nr.	510692	Vergl.-Nr. N/A
Gleitringdichtung für Wellen ø 11mm			
	GEV-Nr.	521023	Vergl.-Nr. —
Lüfterradabdeckung AD ø 150mm H 70mm			
	GEV-Nr.	521702	Vergl.-Nr. N/A
Pumpendeckeldichtung Materialstärke 3,5x4,5mm			



1

GEV-Nr.	499134	Vergl.-Nr.	2282
Beschreibung	Pumpe Eingang ø 45mm Ausgang ø 40mm Typ 2282 230V 50Hz 0,37kW 0,5PS L 205mm Laufrichtung rechts Kondensator 12,5µF Hilfsdruck 11mm Hilfsdruck offen FIR		
Ersatzteile zu	499134		
	GEV-Nr.	365014	Vergl.-Nr. —
	Betriebskondensator Kapazität 12,5µF 400V		
	GEV-Nr.	510607	Vergl.-Nr. N/A
	Laufrad ø 85mm H 29mm Achsaufnahme ø 9x8mm		
	GEV-Nr.	510692	Vergl.-Nr. N/A
	Gleitringdichtung für Wellen ø 11mm		
	GEV-Nr.	521539	Vergl.-Nr. N/A
	Pumpendeckel FIR Eingang ø 45mm Ausgang ø 40mm		
	GEV-Nr.	521702	Vergl.-Nr. N/A
	Pumpendeckeldichtung Materialstärke 3,5x4,5mm		



1

GEV-Nr.	500010	Vergl.-Nr.	2292.1400 2292.1506
Beschreibung	Pumpe Eingang ø 45mm Ausgang ø 40mm Typ 2292.1506 230V 50Hz Phasen 1 0,55kW 0,75PS L 238mm Laufrichtung rechts Kondensator 12,5µF FIR		
Ersatzteile zu	500010		
	GEV-Nr.	365014	Vergl.-Nr. —
	Betriebskondensator Kapazität 12,5µF 400V		

Ersatzteile zu	500010		
	GEV-Nr.	510600	Vergl.-Nr. N/A
	Laufrad ø 102mm H 29mm Achsaufnahme ø 9/8mm		
	GEV-Nr.	510692	Vergl.-Nr. N/A
	Gleitringdichtung für Wellen ø 11mm		
	GEV-Nr.	521023	Vergl.-Nr. —
	Lüfterradabdeckung AD ø 150mm H 70mm		
	GEV-Nr.	521506	Vergl.-Nr. N/A
	Pumpendeckel FIR Eingang ø 45mm Ausgang ø 40mm		
	GEV-Nr.	521702	Vergl.-Nr. N/A
	Pumpendeckeldichtung Materialstärke 3,5x4,5mm		



1

GEV-Nr.	499151	Vergl.-Nr.	3910.1421
Beschreibung	Pumpe Eingang ø 45mm Ausgang ø 40mm Typ 3910.1421 230V 50Hz Phasen 1 0,37kW 0,5PS L 190mm Laufrichtung rechts Kondensator 10µF FIR		
Ersatzteile zu	499151		
	GEV-Nr.	365015	Vergl.-Nr. —
	Betriebskondensator Kapazität 10µF 400V		
	GEV-Nr.	510508	Vergl.-Nr. N/A
	Pumpendeckel FIR Eingang ø 45mm Ausgang ø 40mm		
	GEV-Nr.	510607	Vergl.-Nr. N/A
	Laufrad ø 85mm H 29mm Achsaufnahme ø 9x8mm		
	GEV-Nr.	510692	Vergl.-Nr. N/A
	Gleitringdichtung für Wellen ø 11mm		
	GEV-Nr.	521702	Vergl.-Nr. N/A
	Pumpendeckeldichtung Materialstärke 3,5x4,5mm		



1

GEV-Nr.	500389	Vergl.-Nr.	3911
Beschreibung	Pumpe Eingang ø 45mm Ausgang ø 40mm Typ 3911 230V 50Hz Phasen 1 0,55kW 0,75PS Laufrichtung rechts FIR		



1

GEV-Nr.	500479	Vergl.-Nr.	3911.1423
Beschreibung	Pumpe Eingang ø 45mm Ausgang ø 40mm Typ 3911.1423 230V 50Hz Phasen 1 0,56kW 0,75PS L 204mm Laufrichtung rechts Kondensator 10µF FIR		



1

GEV-Nr.	500249	Vergl.-Nr.	3911.1421
Beschreibung	Pumpe Eingang ø 45mm Ausgang ø 40mm Typ 3911.1421 230V 50Hz Phasen 1 0,55kW 0,75PS L 205mm Laufrichtung rechts Kondensator 12,5µF FIR		

Ersatzteile zu	500249			
	GEV-Nr.	365014	Vergl.-Nr.	—
	Betriebskondensator Kapazität 12,5µF 400V			
	GEV-Nr.	502007	Vergl.-Nr.	N/A
	Pumpendeckeldichtung			
	GEV-Nr.	502014	Vergl.-Nr.	N/A
	Pumpendeckel FIR Eingang ø 45mm Ausgang ø 40mm			
	GEV-Nr.	510610	Vergl.-Nr.	N/A
	Lauftrad ø 95,5mm H 23mm Achsaufnahme ø 9/8mm			
	GEV-Nr.	510692	Vergl.-Nr.	N/A
	Gleitringdichtung für Wellen ø 11mm			

Ersatzteile zu	500479			
	GEV-Nr.	365015	Vergl.-Nr.	—
	Betriebskondensator Kapazität 10µF 400V			
	GEV-Nr.	510508	Vergl.-Nr.	N/A
	Pumpendeckel FIR Eingang ø 45mm Ausgang ø 40mm			
	GEV-Nr.	510610	Vergl.-Nr.	N/A
	Lauftrad ø 95,5mm H 23mm Achsaufnahme ø 9/8mm			
	GEV-Nr.	510692	Vergl.-Nr.	N/A
	Gleitringdichtung für Wellen ø 11mm			
	GEV-Nr.	521702	Vergl.-Nr.	N/A
	Pumpendeckeldichtung Materialstärke 3,5x4,5mm			







1

GEV-Nr.	500038	Vergl.-Nr.	3911.1425
Beschreibung	Pumpe Eingang ø 45mm Ausgang ø 40mm Typ 3911.1425 230V 50Hz Phasen 1 0,55kW 0,75PS L 205mm Laufrichtung rechts Kondensator 10µF FIR		

Ersatzteile zu	500038			
	GEV-Nr.	365015	Vergl.-Nr.	—
	Betriebskondensator Kapazität 10µF 400V			





Tabellenfortsetzung auf der nächsten Seite



Ersatzteile zu 500038			
	GEV-Nr.	510508	Vergl.-Nr. N/A
Pumpendeckel FIR Eingang ø 45mm Ausgang ø 40mm			
	GEV-Nr.	510610	Vergl.-Nr. N/A
Laufgrad ø 95,5mm H 23mm Achsaufnahme ø 9/8mm			
	GEV-Nr.	510692	Vergl.-Nr. N/A
Gleitringdichtung für Wellen ø 11mm			
	GEV-Nr.	521702	Vergl.-Nr. N/A
Pumpendeckeldichtung Materialstärke 3,5x4,5mm			



GEV-Nr.	499189	Vergl.-Nr.	3911.1428
Beschreibung	Pumpe Eingang ø 45mm Ausgang ø 40mm Typ 3911.1428 230V 50Hz Phasen 1 0,55kW 0,75PS L 211mm Laufrichtung rechts Kondensator 12,5µF FIR		

Ersatzteile zu 499189			
	GEV-Nr.	365014	Vergl.-Nr. —
Betriebskondensator Kapazität 12,5µF 400V			
	GEV-Nr.	510508	Vergl.-Nr. N/A
Pumpendeckel FIR Eingang ø 45mm Ausgang ø 40mm			
	GEV-Nr.	510610	Vergl.-Nr. N/A
Laufgrad ø 95,5mm H 23mm Achsaufnahme ø 9/8mm			
	GEV-Nr.	510692	Vergl.-Nr. N/A
Gleitringdichtung für Wellen ø 11mm			
	GEV-Nr.	521702	Vergl.-Nr. N/A
Pumpendeckeldichtung Materialstärke 3,5x4,5mm			



GEV-Nr.	499335	Vergl.-Nr.	3911K1513
Beschreibung	Pumpe Eingang ø 45mm Ausgang ø 40mm Typ 3911K1513 230V 50Hz Phasen 1 0,55kW 0,75PS L 205mm Laufrichtung rechts Kondensator 12,5µF FIR		



Ersatzteile zu 499335			
	GEV-Nr.	365014	Vergl.-Nr. —
Betriebskondensator Kapazität 12,5µF 400V			
	GEV-Nr.	510508	Vergl.-Nr. N/A
Pumpendeckel FIR Eingang ø 45mm Ausgang ø 40mm			
	GEV-Nr.	510610	Vergl.-Nr. N/A
Laufgrad ø 95,5mm H 23mm Achsaufnahme ø 9/8mm			
	GEV-Nr.	510692	Vergl.-Nr. N/A
Gleitringdichtung für Wellen ø 11mm			
	GEV-Nr.	521702	Vergl.-Nr. N/A
Pumpendeckeldichtung Materialstärke 3,5x4,5mm			



GEV-Nr.	501502	Vergl.-Nr.	3911K2530
Beschreibung	Pumpe Eingang ø 45mm Ausgang ø 40mm Typ 3911K2530 180-253V 50Hz Phasen 1 0,55kW 0,75PS L 205mm Laufrichtung rechts Kondensator 10µF FIR		

Ersatzteile zu 501502			
	GEV-Nr.	365014	Vergl.-Nr. —
Betriebskondensator Kapazität 12,5µF 400V			
	GEV-Nr.	510508	Vergl.-Nr. N/A
Pumpendeckel FIR Eingang ø 45mm Ausgang ø 40mm			

Tabellenfortsetzung auf der nächsten Seite

Ersatzteile zu	501502		
	GEV-Nr.	510610	Vergl.-Nr. N/A
	Laufrad ø 95,5mm H 23mm Achsaufnahme ø 9/8mm		
	GEV-Nr.	510692	Vergl.-Nr. N/A
	Gleitringdichtung für Wellen ø 11mm		
	GEV-Nr.	521702	Vergl.-Nr. N/A
	Pumpendeckeldichtung Materialstärke 3,5x4,5mm		



GEV-Nr.	499207	Vergl.-Nr.	3911K2533
Beschreibung	Pumpe Eingang ø 45mm Ausgang ø 40mm Typ 3911K2533 180-253V 50Hz Phasen 1 0,55kW 0,75PS L 205mm Laufrichtung rechts Kondensator 12,5µF FIR		
Ersatzteile zu	499207		
	GEV-Nr.	365014	Vergl.-Nr. —
	Betriebskondensator Kapazität 12,5µF 400V		
	GEV-Nr.	510508	Vergl.-Nr. N/A
	Pumpendeckel FIR Eingang ø 45mm Ausgang ø 40mm		
	GEV-Nr.	510610	Vergl.-Nr. N/A
	Laufrad ø 95,5mm H 23mm Achsaufnahme ø 9/8mm		
	GEV-Nr.	510692	Vergl.-Nr. N/A
	Gleitringdichtung für Wellen ø 11mm		
	GEV-Nr.	521702	Vergl.-Nr. N/A
	Pumpendeckeldichtung Materialstärke 3,5x4,5mm		



GEV-Nr.	500025	Vergl.-Nr.	3981.1400
Beschreibung	Pumpe Eingang ø 45mm Ausgang ø 40mm Typ 3981.1400 230V 50Hz Phasen 1 0,24kW 0,33PS Laufrichtung rechts FIR		



GEV-Nr.	500550	Vergl.-Nr.	3983
Beschreibung	Pumpe Eingang ø 45mm Ausgang ø 40mm Typ 3983 230V 50Hz Phasen 1 0,37kW 0,5PS L 210mm Laufrichtung rechts Kondensator 12,5µF FIR		
Ersatzteile zu	500550		
	GEV-Nr.	502014	Vergl.-Nr. N/A
	Pumpendeckel FIR Eingang ø 45mm Ausgang ø 40mm		



1			
GEV-Nr.	499043	Vergl.-Nr.	3983.1409
Beschreibung	Pumpe Eingang ø 45mm Ausgang ø 40mm Typ 3983.1409 230V 50Hz Phasen 1 0,37kW 0,51PS L 205mm Laufrichtung rechts Kondensator 12,5µF FIR inkl. Kondensator		
Ersatzteile zu	499043		
	GEV-Nr.	365014	Vergl.-Nr. —
	Betriebskondensator Kapazität 12,5µF 400V		
	GEV-Nr.	510607	Vergl.-Nr. N/A
	Laufrad ø 85mm H 29mm Achsaufnahme ø 9x8mm		
	GEV-Nr.	510692	Vergl.-Nr. N/A
	Gleitringdichtung für Wellen ø 11mm		
	GEV-Nr.	521539	Vergl.-Nr. N/A
	Pumpendeckel FIR Eingang ø 45mm Ausgang ø 40mm		
	GEV-Nr.	521702	Vergl.-Nr. N/A
	Pumpendeckeldichtung Materialstärke 3,5x4,5mm		



1			
GEV-Nr.	500375	Vergl.-Nr.	3983
Beschreibung	Pumpe Eingang ø 45mm Ausgang ø 40mm Typ 3983.1411 230V 50Hz Phasen 1 0,37kW 0,5PS L 200mm Laufrichtung rechts Kondensator 12,5µF FIR		







1			
GEV-Nr.	500464	Vergl.-Nr.	4217
Beschreibung	Pumpe Eingang ø 45mm Ausgang ø 40mm Typ 4217 230V 50Hz Phasen 1 0,56kW 0,75PS L 290mm Laufrichtung rechts Kondensator 12,5µF FIR		
Ersatzteile zu	500464		
	GEV-Nr.	365014	Vergl.-Nr. —
	Betriebskondensator Kapazität 12,5µF 400V		



1			
GEV-Nr.	500264	Vergl.-Nr.	4217.2100
Beschreibung	Pumpe Eingang ø 45mm Ausgang ø 40mm Typ 4217.2100 400V 50Hz Phasen 3 0,55kW 0,75PS L 285mm Laufrichtung rechts FIR		
Ersatzteile zu	500264		
	GEV-Nr.	510610	Vergl.-Nr. N/A
	Laufrad ø 95,5mm H 23mm Achsaufnahme ø 9/8mm		
	GEV-Nr.	510692	Vergl.-Nr. N/A
	Gleitringdichtung für Wellen ø 11mm		
	GEV-Nr.	521506	Vergl.-Nr. N/A
	Pumpendeckel FIR Eingang ø 45mm Ausgang ø 40mm		
	GEV-Nr.	521702	Vergl.-Nr. N/A
	Pumpendeckeldichtung Materialstärke 3,5x4,5mm		







1

GEV-Nr.	500266	Vergl.-Nr.	4217/A1 4217B2720
Beschreibung	Pumpe Eingang ø 45mm Ausgang ø 40mm Typ 4217B2720 230/400V 50Hz Phasen 3 0,075kW 1PS L 290mm Laufrichtung rechts FIR		
Ersatzteile zu	500266		
	GEV-Nr. 510508	Vergl.-Nr.	N/A
	Pumpendeckel FIR Eingang ø 45mm Ausgang ø 40mm		
	GEV-Nr. 510600	Vergl.-Nr.	N/A
	Laufrad ø 102mm H 29mm Achsaufnahme ø 9/8mm		
	GEV-Nr. 510692	Vergl.-Nr.	N/A
	Gleitringdichtung für Wellen ø 11mm		
	GEV-Nr. 521702	Vergl.-Nr.	N/A
	Pumpendeckeldichtung Materialstärke 3,5x4,5mm		



1

GEV-Nr.	499128	Vergl.-Nr.	4228.1503
Beschreibung	Pumpe Eingang ø 45mm Ausgang ø 40mm Typ 4228.1503 230V 50Hz 0,55kW L 207mm Laufrichtung rechts Kondensator 12,5µF FIR		
Ersatzteile zu	499128		
	GEV-Nr. 365014	Vergl.-Nr.	—
	Betriebskondensator Kapazität 12,5µF 400V		
	GEV-Nr. 510508	Vergl.-Nr.	N/A
	Pumpendeckel FIR Eingang ø 45mm Ausgang ø 40mm		

Ersatzteile zu	499128		
	GEV-Nr. 510693	Vergl.-Nr.	N/A
	Gleitringdichtung für Wellen ø 12mm		
	GEV-Nr. 521702	Vergl.-Nr.	N/A
	Pumpendeckeldichtung Materialstärke 3,5x4,5mm		
	GEV-Nr. 524358	Vergl.-Nr.	N/A
	Laufrad ø 96mm H 23mm Achsaufnahme ø M7Lmm		



1

GEV-Nr.	500400	Vergl.-Nr.	4255.1600
Beschreibung	Pumpe Eingang ø 45mm Ausgang ø 40mm Typ 4255.1600 230V 50Hz Phasen 1 0,55kW 0,75PS L 215mm Laufrichtung rechts Kondensator 12,5µF FIR		
Ersatzteile zu	500400		
	GEV-Nr. 365014	Vergl.-Nr.	—
	Betriebskondensator Kapazität 12,5µF 400V		
	GEV-Nr. 510692	Vergl.-Nr.	N/A
	Gleitringdichtung für Wellen ø 11mm		
	GEV-Nr. 521210	Vergl.-Nr.	N/A
	Laufrad ø 96mm H 30mm Achsaufnahme ø 9/8mm		
	GEV-Nr. 521506	Vergl.-Nr.	N/A
	Pumpendeckel FIR Eingang ø 45mm Ausgang ø 40mm		
	GEV-Nr. 521702	Vergl.-Nr.	N/A
	Pumpendeckeldichtung Materialstärke 3,5x4,5mm		



1

GEV-Nr.	499045	Vergl.-Nr.	4268.2350
Beschreibung	Pumpe Eingang ø 45mm Ausgang ø 40mm Typ 4268.2350 230V 50Hz Phasen 1 0,45kW 0,6PS L 205mm Laufrichtung rechts Kondensator 12,5µF FIR		



1





GEV-Nr.	500981	Vergl.-Nr.	4281.2350
Beschreibung	Pumpe Eingang ø 45mm Ausgang ø 40mm Typ 4281.2350 230V 50Hz Phasen 1 0,55kW 0,75PS L 230mm Laufrichtung rechts Kondensator 12,5µF FIR		



1

GEV-Nr.	499123	Vergl.-Nr.	4296.2350	
Beschreibung	Pumpe Eingang ø 45mm Ausgang ø 40mm Typ 4296.2350 230V 50Hz Phasen 1 0,75kW L 250mm Laufrichtung rechts Kondensator 16µF FIR			
Ersatzteile zu	499123			
	GEV-Nr.	365021	Vergl.-Nr.	—
	Betriebskondensator Kapazität 16µF 425V			

Ersatzteile zu 499123

	GEV-Nr.	510608	Vergl.-Nr.	N/A
	Laufrad ø 93mm H 32mm Achsaufnahme ø 9/8mm			
	GEV-Nr.	510692	Vergl.-Nr.	N/A
	Gleitringdichtung für Wellen ø 11mm			
	GEV-Nr.	521539	Vergl.-Nr.	N/A
	Pumpendeckel FIR Eingang ø 45mm Ausgang ø 40mm			
	GEV-Nr.	521702	Vergl.-Nr.	N/A
	Pumpendeckeldichtung Materialstärke 3,5x4,5mm			



1

GEV-Nr.	501401	Vergl.-Nr.	5283	
Beschreibung	Pumpe Eingang ø 45mm Ausgang ø 40mm Typ 5283 230V 50Hz Phasen 1 0,37kW L 205mm FIR			
Ersatzteile zu	501401			
	GEV-Nr.	365014	Vergl.-Nr.	—
	Betriebskondensator Kapazität 12,5µF 400V			
	GEV-Nr.	510608	Vergl.-Nr.	N/A
	Laufrad ø 93mm H 32mm Achsaufnahme ø 9/8mm			
	GEV-Nr.	510692	Vergl.-Nr.	N/A
	Gleitringdichtung für Wellen ø 11mm			
	GEV-Nr.	521506	Vergl.-Nr.	N/A
	Pumpendeckel FIR Eingang ø 45mm Ausgang ø 40mm			
	GEV-Nr.	521702	Vergl.-Nr.	N/A
	Pumpendeckeldichtung Materialstärke 3,5x4,5mm			



1

GEV-Nr.	501400	Vergl.-Nr.	B206.1500
Beschreibung	Pumpe Eingang ø 45mm Ausgang ø 40mm Typ B206.1500 230V 50Hz Phasen 1 0,55kW L 235mm FIR		
Ersatzteile zu	501400		
	GEV-Nr.	Vergl.-Nr.	—
	365014		
	Betriebskondensator Kapazität 12,5µF 400V		
	GEV-Nr.	Vergl.-Nr.	N/A
	510508		
	Pumpendeckel FIR Eingang ø 45mm Ausgang ø 40mm		
	GEV-Nr.	Vergl.-Nr.	N/A
	510600		
	Laufrad ø 102mm H 29mm Achsaufnahme ø 9/8mm		
	GEV-Nr.	Vergl.-Nr.	N/A
	510692		
	Gleitringdichtung für Wellen ø 11mm		
	GEV-Nr.	Vergl.-Nr.	—
	521023		
	Lüfterradabdeckung AD ø 150mm H 70mm		
	GEV-Nr.	Vergl.-Nr.	N/A
	521702		
	Pumpendeckeldichtung Materialstärke 3,5x4,5mm		



1

GEV-Nr.	500396	Vergl.-Nr.	B257.1605 B257.1700
Beschreibung	Pumpe Eingang ø 45mm Ausgang ø 40mm Typ B257.1700 230V 50Hz Phasen 1 0,75kW 1PS L 220mm Laufrichtung rechts Kondensator 16µF FIR		
Ersatzteile zu	500396		
	GEV-Nr.	Vergl.-Nr.	—
	365021		
	Betriebskondensator Kapazität 16µF 425V		

Ersatzteile zu	500396		
	GEV-Nr.	Vergl.-Nr.	N/A
	510508		
	Pumpendeckel FIR Eingang ø 45mm Ausgang ø 40mm		
	GEV-Nr.	Vergl.-Nr.	N/A
	510692		
	Gleitringdichtung für Wellen ø 11mm		
	GEV-Nr.	Vergl.-Nr.	N/A
	521001		
	Laufrad ø 91mm H 30mm Pumpentyp B267.4050		
	GEV-Nr.	Vergl.-Nr.	N/A
	521702		
	Pumpendeckeldichtung Materialstärke 3,5x4,5mm		



1

GEV-Nr.	500370	Vergl.-Nr.	B267.2350
Beschreibung	Pumpe Eingang ø 45mm Ausgang ø 40mm Typ B267.2350 230V 50Hz Phasen 1 0,55kW 0,75PS L 230mm Laufrichtung rechts Kondensator 16µF FIR		
Ersatzteile zu	500370		
	GEV-Nr.	Vergl.-Nr.	—
	365021		
	Betriebskondensator Kapazität 16µF 425V		
	GEV-Nr.	Vergl.-Nr.	N/A
	510693		
	Gleitringdichtung für Wellen ø 12mm		
	GEV-Nr.	Vergl.-Nr.	N/A
	521506		
	Pumpendeckel FIR Eingang ø 45mm Ausgang ø 40mm		
	GEV-Nr.	Vergl.-Nr.	N/A
	521702		
	Pumpendeckeldichtung Materialstärke 3,5x4,5mm		



GEV-Nr.	500369	Vergl.-Nr.	B267.4050
Beschreibung	Pumpe Eingang ø 45mm Ausgang ø 40mm Typ B267.4050 230/400V 50Hz Phasen 3 0,75kW 1PS L 230mm Laufrichtung rechts FIR		
Ersatzteile zu	500369		
	GEV-Nr.	510692	Vergl.-Nr. N/A
	Gleitringdichtung für Wellen ø 11mm		
	GEV-Nr.	521001	Vergl.-Nr. N/A
	Laufgrad ø 91mm H 30mm Pumpentyp B267.4050		
	GEV-Nr.	521506	Vergl.-Nr. N/A
	Pumpendeckel FIR Eingang ø 45mm Ausgang ø 40mm		
	GEV-Nr.	521702	Vergl.-Nr. N/A
	Pumpendeckeldichtung Materialstärke 3,5x4,5mm		



GEV-Nr.	499304	Vergl.-Nr.	3983.1409
Beschreibung	Pumpe Eingang ø 45mm Ausgang ø 41mm Typ 3983.1409 230V 50Hz Phasen 1 0,37kW 0,5PS L 200mm Laufrichtung rechts Kondensator 12,5µF FIR Kit		
Ersatzteile zu	499304		
	GEV-Nr.	365014	Vergl.-Nr. —
	Betriebskondensator Kapazität 12,5µF 400V		
	GEV-Nr.	510607	Vergl.-Nr. N/A
	Laufgrad ø 85mm H 29mm Achsaufnahme ø 9x8mm		
	GEV-Nr.	510692	Vergl.-Nr. N/A
	Gleitringdichtung für Wellen ø 11mm		
	GEV-Nr.	521539	Vergl.-Nr. N/A
	Pumpendeckel FIR Eingang ø 45mm Ausgang ø 40mm		
	GEV-Nr.	521702	Vergl.-Nr. N/A
	Pumpendeckeldichtung Materialstärke 3,5x4,5mm		



GEV-Nr.	499285	Vergl.-Nr.	4242.1400
Beschreibung	Pumpe Eingang ø 45mm Ausgang ø 43mm Typ 4242.1400 230V 50Hz Phasen 1 0,37kW 0,5PS L 270mm Laufrichtung rechts FIR		



GEV-Nr.	500989	Vergl.-Nr.	4242.1500
Beschreibung	Pumpe Eingang ø 45mm Ausgang ø 43mm Typ 4242.1500 230V 50Hz Phasen 1 0,55kW 0,75PS L 275mm Laufrichtung rechts Kondensator 12,5µF FIR 2800U/min		
Ersatzteile zu	500989		
	GEV-Nr.	365014	Vergl.-Nr. —
	Betriebskondensator Kapazität 12,5µF 400V		



1

GEV-Nr.	500560	Vergl.-Nr.	B250.1500
Beschreibung	Pumpe Eingang ø 50mm Ausgang ø 37mm Typ B250.1500 230V 50Hz Phasen 1 0,9kW 1,2PS L 265mm Laufrichtung links Kondensator 12,5µF FIR		
Ersatzteile zu	500560		
	GEV-Nr.	365014	Vergl.-Nr. —
	Betriebskondensator Kapazität 12,5µF 400V		
	GEV-Nr.	510693	Vergl.-Nr. N/A
	Gleitringdichtung für Wellen ø 12mm		
	GEV-Nr.	521273	Vergl.-Nr. N/A
	Laufrad ø 103mm H 27mm Laufrichtung links		
	GEV-Nr.	521567	Vergl.-Nr. N/A
	Pumpendeckel FIR Eingang ø 50mm Ausgang ø 37mm		
	GEV-Nr.	521702	Vergl.-Nr. N/A
	Pumpendeckeldichtung Materialstärke 3,5x4,5mm		

Ersatzteile zu 499055

	GEV-Nr.	509031	Vergl.-Nr. —
	Laufrad ø 93mm H 31mm Welle ø 12mm		
	GEV-Nr.	510552	Vergl.-Nr. N/A
	Pumpendeckeldichtung		
	GEV-Nr.	510692	Vergl.-Nr. N/A
	Gleitringdichtung für Wellen ø 11mm		
	GEV-Nr.	513713	Vergl.-Nr. —
	Pumpendeckelunterteil		
	GEV-Nr.	521562	Vergl.-Nr. —
	Pumpendeckel		
	GEV-Nr.	523509	Vergl.-Nr. —
	Rillenkugellager Welle ø 12mm AD ø 32mm B 10mm		



1

GEV-Nr.	499055	Vergl.-Nr.	0237
Beschreibung	Pumpe Eingang ø 50mm Ausgang ø 49mm Typ 0237 220-240V 50Hz Phasen 1 0,6kW 0,8PS L 230mm Laufrichtung rechts Kondensator 16µF FIR		
Ersatzteile zu	499055		
	GEV-Nr.	365021	Vergl.-Nr. —
	Betriebskondensator Kapazität 16µF 425V		



1

GEV-Nr.	500927	Vergl.-Nr.	0213.1600
Beschreibung	Pumpe Eingang ø 53mm Ausgang ø 44mm Typ 0213.1600 230V 50/60Hz Phasen 1 1kW 1,36PS L 290mm Laufrichtung rechts Kondensator 12,5µF FIR		
Ersatzteile zu	500927		
	GEV-Nr.	365014	Vergl.-Nr. —
	Betriebskondensator Kapazität 12,5µF 400V		
	GEV-Nr.	509010	Vergl.-Nr. N/A
	Laufrad ø 105mm H 20mm M10L Laufrichtung rechts		
	GEV-Nr.	510693	Vergl.-Nr. N/A
	Gleitringdichtung für Wellen ø 12mm		
	GEV-Nr.	521543	Vergl.-Nr. —
	Pumpendeckel ELFRAMO Eingang ø 53mm Ausgang ø 44mm		
	GEV-Nr.	521717	Vergl.-Nr. —
	O-Ring EPDM Materialstärke 1,78mm ID ø 120,37mm		



GEV-Nr.	500278	Vergl.-Nr.	AF90L/2C-12
Beschreibung	Pumpe Eingang ø 57mm Ausgang ø 49mm Typ AF90L/2C-12 400V 50Hz Phasen 3 2,7kW 3,7PS L 400mm Laufrichtung rechts FIR Eingang ø 57mm Ausgang ø 49mm		
Ersatzteile zu	500278		
	GEV-Nr.	502002	Vergl.-Nr. —
	Dichtungssatz		
	GEV-Nr.	502008	Vergl.-Nr. —
	Laufrad ø 137mm H 45mm		



GEV-Nr.	499091	Vergl.-Nr.	2233S1500
Beschreibung	Pumpe Eingang ø 60mm Ausgang ø 47mm Typ 2233S1500 230V 50Hz Phasen 1 0,89kW 1,22PS L 251mm Laufrichtung rechts Kondensator 16µF FIR		
Ersatzteile zu	499091		
	GEV-Nr.	365021	Vergl.-Nr. —
	Betriebskondensator Kapazität 16µF 425V		
	GEV-Nr.	510552	Vergl.-Nr. N/A
	Pumpendeckeldichtung		
	GEV-Nr.	510693	Vergl.-Nr. N/A
	Gleitringdichtung für Wellen ø 12mm		
	GEV-Nr.	521067	Vergl.-Nr. N/A
	Servicekit für Pumpe Typ 2233S1500		
	GEV-Nr.	521512	Vergl.-Nr. N/A
	Pumpendeckel FIR Eingang ø 60mm Ausgang ø 50mm		







GEV-Nr.	500527	Vergl.-Nr.	2233.B140
Beschreibung	Pumpe Eingang ø 60mm Ausgang ø 50/30mm Typ 2233.B140 230V 50Hz Phasen 1 0,55kW 0,75PS L 210mm Laufrichtung rechts Kondensator 12,5µF FIR Eingang ø 60mm		
Ersatzteile zu	500527		
	GEV-Nr.	365014	Vergl.-Nr. —
	Betriebskondensator Kapazität 12,5µF 400V		
	GEV-Nr.	510552	Vergl.-Nr. N/A
	Pumpendeckeldichtung		
	GEV-Nr.	510608	Vergl.-Nr. N/A
	Laufrad ø 93mm H 32mm Achsaufnahme ø 9/8mm		
	GEV-Nr.	510692	Vergl.-Nr. N/A
	Gleitringdichtung für Wellen ø 11mm		
	GEV-Nr.	521511	Vergl.-Nr. N/A
	Pumpendeckel Eingang ø 60mm Ausgang ø 50/30mm		



GEV-Nr.	500683	Vergl.-Nr.	2233.U150
Beschreibung	Pumpe Eingang ø 60mm Ausgang ø 50mm Typ 2233.U150 230V 50Hz Phasen 1 0,89kW 1,2PS L 260mm Laufrichtung rechts Kondensator 16µF FIR		
Ersatzteile zu	500683		
	GEV-Nr.	365021	Vergl.-Nr. —
	Betriebskondensator Kapazität 16µF 425V		

Tabellenfortsetzung auf der nächsten Seite

Ersatzteile zu	500683		
	GEV-Nr.	510552	Vergl.-Nr. N/A
Pumpendeckeldichtung			
	GEV-Nr.	510600	Vergl.-Nr. N/A
Laufrad ø 102mm H 29mm Achsaufnahme ø 9/8mm			
	GEV-Nr.	510692	Vergl.-Nr. N/A
Gleitringdichtung für Wellen ø 11mm			
	GEV-Nr.	521511	Vergl.-Nr. N/A
Pumpendeckel Eingang ø 60mm Ausgang ø 50/30mm			



GEV-Nr.	499231	Vergl.-Nr.	2233A2350
Beschreibung	Pumpe Eingang ø 60mm Ausgang ø 50mm Typ 2233A2350 230V 50Hz Phasen 1 0,75kW L 255mm Laufrichtung rechts Kondensator 16µF FIR für Schläuche im Unterbau (Hygienebrücke) Eingang ø 60mm Ausgang ø 50mm		
Ersatzteile zu	499231		
	GEV-Nr.	365021	Vergl.-Nr. —
Betriebskondensator Kapazität 16µF 425V			
	GEV-Nr.	510529	Vergl.-Nr. N/A
Laufrad ø 103mm H 30mm Achsaufnahme ø 9/8mm			
	GEV-Nr.	510552	Vergl.-Nr. N/A
Pumpendeckeldichtung			
	GEV-Nr.	510692	Vergl.-Nr. N/A
Gleitringdichtung für Wellen ø 11mm			
	GEV-Nr.	521512	Vergl.-Nr. N/A
Pumpendeckel FIR Eingang ø 60mm Ausgang ø 50mm			



GEV-Nr.	500709	Vergl.-Nr.	2278A2251
Beschreibung	Pumpe Eingang ø 60mm Ausgang ø 50mm Typ 2278 230V 50Hz Phasen 1 0,75kW 1PS L 300mm Laufrichtung rechts Kondensator 16µF FIR		



GEV-Nr.	500544	Vergl.-Nr.	4223.1900
Beschreibung	Pumpe Eingang ø 60mm Ausgang ø 50mm Typ 4223.1900 230V 50Hz Phasen 1 0,73kW 1PS L 225mm Laufrichtung rechts Kondensator 16µF FIR		
Ersatzteile zu	500544		
	GEV-Nr.	365021	Vergl.-Nr. —
Betriebskondensator Kapazität 16µF 425V			
	GEV-Nr.	510552	Vergl.-Nr. N/A
Pumpendeckeldichtung			
	GEV-Nr.	510693	Vergl.-Nr. N/A
Gleitringdichtung für Wellen ø 12mm			
	GEV-Nr.	518067	Vergl.-Nr. N/A
Laufrad ø 103mm H 29mm M7L			
	GEV-Nr.	521512	Vergl.-Nr. N/A
Pumpendeckel FIR Eingang ø 60mm Ausgang ø 50mm			



1

GEV-Nr.	500528	Vergl.-Nr.	4233.1500
Beschreibung	Pumpe Eingang ø 60mm Ausgang ø 50mm Typ 4233.1500 230V 50Hz Phasen 1 0,74kW 1PS L 220mm Laufrichtung rechts Kondensator 16µF FIR		
Ersatzteile zu	500528		
	GEV-Nr.	365021	Vergl.-Nr. —
	Betriebskondensator Kapazität 16µF 425V		
	GEV-Nr.	510552	Vergl.-Nr. N/A
	Pumpendeckeldichtung		
	GEV-Nr.	510693	Vergl.-Nr. N/A
	Gleitringdichtung für Wellen ø 12mm		
	GEV-Nr.	517319	Vergl.-Nr. —
	Schlauchanschluss G1: M12x1,75 Schlauch ø 11mm		
	GEV-Nr.	521177	Vergl.-Nr. N/A
	Laufgrad ø 93mm H 23mm Gewinde M10L passend für FIR		
	GEV-Nr.	521511	Vergl.-Nr. N/A
	Pumpendeckel Eingang ø 60mm Ausgang ø 50/30mm		





1

GEV-Nr.	499281	Vergl.-Nr.	4298.1404
Beschreibung	Pumpe Eingang ø 60mm Ausgang ø 50mm Typ 4298.1404 230V 50Hz Phasen 1 1,1kW L 210mm Laufrichtung rechts Kondensator 12,5µF FIR		
Ersatzteile zu	499281		
	GEV-Nr.	365014	Vergl.-Nr. —
	Betriebskondensator Kapazität 12,5µF 400V		
	GEV-Nr.	510600	Vergl.-Nr. N/A
	Laufgrad ø 102mm H 29mm Achsaufnahme ø 9/8mm		
	GEV-Nr.	510692	Vergl.-Nr. N/A
	Gleitringdichtung für Wellen ø 11mm		
	GEV-Nr.	521702	Vergl.-Nr. N/A
	Pumpendeckeldichtung Materialstärke 3,5x4,5mm		
	GEV-Nr.	698762	Vergl.-Nr. N/A
	Pumpendeckel FIR Eingang ø 60mmmm Ausgang ø 50mmmm		



1

GEV-Nr.	499336	Vergl.-Nr.	2250.2732
Beschreibung	Pumpe Eingang ø 62 Ausgang ø 62 Typ 2250.2732 230/400V 50Hz 2,95kW 4PS		
Ersatzteile zu	499336		
	GEV-Nr.	510687	Vergl.-Nr. N/A
	Gleitringdichtung für Wellen ø 18mm		
	GEV-Nr.	521026	Vergl.-Nr. N/A
	Pumpendeckeldichtung ID ø 182,5mm		
	GEV-Nr.	521028	Vergl.-Nr. N/A
	Pumpendeckel FIR Eingang ø 62mm Ausgang ø 62mm		

Tabellenfortsetzung auf der nächsten Seite

Ersatzteile zu	499336		
	GEV-Nr.	521277	Vergl.-Nr. N/A
Laufrad ø 135mm H 39mm Pumpentyp Fir 2275; 3,7PS			



1

GEV-Nr.	500098	Vergl.-Nr.	B215.2500
Beschreibung	Pumpe Eingang ø 62mm Ausgang ø 49mm Typ B215.2500 230/400V 50/60Hz Phasen 3 1,5kW 2PS L 332mm Laufrichtung rechts FIR		

Ersatzteile zu	500098		
	GEV-Nr.	510693	Vergl.-Nr. N/A
Gleitringdichtung für Wellen ø 12mm			
	GEV-Nr.	511148	Vergl.-Nr. —
Laufrad ø 118mm H 20mm M10L			
	GEV-Nr.	521544	Vergl.-Nr. N/A
Pumpendeckel Eingang ø 63mm Ausgang ø 50mm			
	GEV-Nr.	521718	Vergl.-Nr. N/A
O-Ring EPDM Materialstärke 3,53mm ID ø 164,7mm			



1

GEV-Nr.	499051	Vergl.-Nr.	B214.1600
Beschreibung	Pumpe Eingang ø 62mm Ausgang ø 50mm Typ B214 230V 50/60Hz Phasen 1 1kW Laufrichtung rechts Kondensator 12,5µF FIR		

Ersatzteile zu	499051		
	GEV-Nr.	365014	Vergl.-Nr. —
Betriebskondensator Kapazität 12,5µF 400V			

Ersatzteile zu	499051		
	GEV-Nr.	509010	Vergl.-Nr. N/A
Laufrad ø 105mm H 20mm M10L Laufrichtung rechts			
	GEV-Nr.	510693	Vergl.-Nr. N/A
Gleitringdichtung für Wellen ø 12mm			
	GEV-Nr.	517174	Vergl.-Nr. —
Mutter Gewinde M8 H 6,5mm SW 13 CNS			
	GEV-Nr.	521544	Vergl.-Nr. N/A
Pumpendeckel Eingang ø 63mm Ausgang ø 50mm			
	GEV-Nr.	521718	Vergl.-Nr. N/A
O-Ring EPDM Materialstärke 3,53mm ID ø 164,7mm			
	GEV-Nr.	560312	Vergl.-Nr. —
Unterlegscheibe ID ø 10,5mm AD ø 20mm			



1

GEV-Nr.	499268	Vergl.-Nr.	4290.6600
Beschreibung	Pumpe Eingang ø 62mm Ausgang ø 61mm Typ 4290.6600 220-254/380-440V 60Hz Phasen 3 1,5kW L 350mm Laufrichtung rechts FIR		



1

GEV-Nr.	499334	Vergl.-Nr.	2250.2731 2250/C
Beschreibung	Pumpe Eingang ø 62mm Ausgang ø 62mm Typ 2250.2731 230/400V 50Hz Phasen 1 3kW FIR		
Ersatzteile zu	499334		
	GEV-Nr.	510687	Vergl.-Nr. N/A
	Gleitringdichtung für Wellen ø 18mm		
	GEV-Nr.	512455	Vergl.-Nr. —
	Lüfterrad ø 155mm H 18mm Achsaufnahme ø 18mm		
	GEV-Nr.	521026	Vergl.-Nr. N/A
	Pumpendeckeldichtung ID ø 182,5mm		
	GEV-Nr.	521028	Vergl.-Nr. N/A
	Pumpendeckel FIR Eingang ø 62mm Ausgang ø 62mm		
	GEV-Nr.	521277	Vergl.-Nr. N/A
	Laufrad ø 135mm H 39mm Pumpentyp Fir 2275; 3,7PS		



1

GEV-Nr.	499139	Vergl.-Nr.	2275.2722
Beschreibung	Pumpe Eingang ø 62mm Ausgang ø 62mm Typ 2275.2722 230/400V 50Hz Phasen 3 2,6kW L 400mm Laufrichtung rechts FIR		
Ersatzteile zu	499139		
	GEV-Nr.	510687	Vergl.-Nr. N/A
	Gleitringdichtung für Wellen ø 18mm		
	GEV-Nr.	521026	Vergl.-Nr. N/A
	Pumpendeckeldichtung ID ø 182,5mm		
	GEV-Nr.	521028	Vergl.-Nr. N/A
	Pumpendeckel FIR Eingang ø 62mm Ausgang ø 62mm		

Ersatzteile zu 499139

	GEV-Nr.	521277	Vergl.-Nr.	N/A
	Laufrad ø 135mm H 39mm Pumpentyp Fir 2275; 3,7PS			
	GEV-Nr.	524676	Vergl.-Nr.	—
	Lüfterrad ø 160mm Achsaufnahme ø 24mm Kunststoff			



1

GEV-Nr.	500986	Vergl.-Nr.	4290.2700
Beschreibung	Pumpe Eingang ø 62mm Ausgang ø 62mm Typ 4290.2700 220-240/380-415V 50Hz Phasen 3 1,5kW 2PS L 350mm Laufrichtung rechts FIR		
Ersatzteile zu	500986		
	GEV-Nr.	510687	Vergl.-Nr. N/A
	Gleitringdichtung für Wellen ø 18mm		
	GEV-Nr.	521017	Vergl.-Nr. N/A
	Laufrad ø 120mm H 35mm Laufrichtung rechts		
	GEV-Nr.	521026	Vergl.-Nr. N/A
	Pumpendeckeldichtung ID ø 182,5mm		
	GEV-Nr.	521028	Vergl.-Nr. N/A
	Pumpendeckel FIR Eingang ø 62mm Ausgang ø 62mm		



1

GEV-Nr.	500985	Vergl.-Nr.	4290.2700
Beschreibung	Pumpe Eingang ø 62mm Ausgang ø 64mm Typ 4290.2700 220-240/380-415V 50Hz Phasen 3 1,5kW 2PS L 350mm Laufrichtung rechts FIR inkl. Montagekit		



1

GEV-Nr.	501487	Vergl.-Nr.	4267.5050
Beschreibung	Pumpe Eingang ø 63mm Ausgang ø 40mm Typ 4267.5050 230/400V 50Hz Phasen 3 1,5kW L 300mm Laufrichtung rechts FIR		
Ersatzteile zu	501487		
	GEV-Nr.	502273	Vergl.-Nr. N/A
	Pumpendeckel FIR Eingang ø 63mm Ausgang ø 2x40mm		
	GEV-Nr.	510602	Vergl.-Nr. 1225315/S
	Laufrad ø 110mm H 34mm Laufrichtung rechts		
	GEV-Nr.	510693	Vergl.-Nr. N/A
	Gleitringdichtung für Wellen ø 12mm		
	GEV-Nr.	524416	Vergl.-Nr. N/A
	Pumpendeckeldichtung Materialstärke 4x4mm		



1

GEV-Nr.	500112	Vergl.-Nr.	1214.1000
Beschreibung	Pumpe Eingang ø 63mm Ausgang ø 47mm 230/400V 50Hz Phasen 3 0,55kW 0,75PS L 305mm Laufrichtung rechts FIR		
Ersatzteile zu	500112		
	GEV-Nr.	510601	Vergl.-Nr. N/A
	Laufrad ø 103mm H 25mm Laufrichtung rechts		
	GEV-Nr.	510693	Vergl.-Nr. N/A
	Gleitringdichtung für Wellen ø 12mm		

Ersatzteile zu	500112		
	GEV-Nr.	521513	Vergl.-Nr. N/A
	Pumpendeckel FIR Eingang ø 63mm Ausgang ø 47mm		
	GEV-Nr.	524416	Vergl.-Nr. N/A
	Pumpendeckeldichtung Materialstärke 4x4mm		



1



GEV-Nr.	500056	Vergl.-Nr.	1211.2706 1211ST.10
Beschreibung	Pumpe Eingang ø 63mm Ausgang ø 47mm Typ 1211.2706 230/400V 50Hz Phasen 3 0,55kW 0,75PS L 305mm Laufrichtung rechts FIR		
Ersatzteile zu	500056		
	GEV-Nr.	510601	Vergl.-Nr. N/A
	Laufrad ø 103mm H 25mm Laufrichtung rechts		
	GEV-Nr.	510693	Vergl.-Nr. N/A
	Gleitringdichtung für Wellen ø 12mm		
	GEV-Nr.	521513	Vergl.-Nr. N/A
	Pumpendeckel FIR Eingang ø 63mm Ausgang ø 47mm		
	GEV-Nr.	524416	Vergl.-Nr. N/A
	Pumpendeckeldichtung Materialstärke 4x4mm		



1

GEV-Nr.	500687	Vergl.-Nr.	1211ST.10
Beschreibung	Pumpe Eingang ø 63mm Ausgang ø 47mm Typ 1211ST.10 230/400V 50Hz Phasen 3 0,55kW 0,75PS L 305mm Laufrichtung rechts FIR		
Ersatzteile zu	500687		
	GEV-Nr.	510601	Vergl.-Nr. N/A
	Laufrad ø 103mm H 25mm Laufrichtung rechts		

Tabellenfortsetzung auf der nächsten Seite

Ersatzteile zu 500687			
	GEV-Nr.	510693	Vergl.-Nr. N/A
Gleitringdichtung für Wellen ø 12mm			
	GEV-Nr.	521513	Vergl.-Nr. N/A
Pumpendeckel FIR Eingang ø 63mm Ausgang ø 47mm			
	GEV-Nr.	524416	Vergl.-Nr. N/A
Pumpendeckeldichtung Materialstärke 4x4mm			







1

GEV-Nr.	500155	Vergl.-Nr.	1225
Beschreibung	Pumpe Eingang ø 63mm Ausgang ø 47mm Typ 1225 230V 50Hz Phasen 1 1,1kW 1,5PS L 335mm Laufrichtung rechts Kondensator 31,5µF FIR		
Ersatzteile zu 500155			
	GEV-Nr.	365016	Vergl.-Nr. —
Betriebskondensator Kapazität 31,5µF 400V			
	GEV-Nr.	510602	Vergl.-Nr. 1225315/S
Laufrad ø 110mm H 34mm Laufrichtung rechts			
	GEV-Nr.	510693	Vergl.-Nr. N/A
Gleitringdichtung für Wellen ø 12mm			
	GEV-Nr.	521513	Vergl.-Nr. N/A
Pumpendeckel FIR Eingang ø 63mm Ausgang ø 47mm			
	GEV-Nr.	524416	Vergl.-Nr. N/A
Pumpendeckeldichtung Materialstärke 4x4mm			





1



GEV-Nr.	500708	Vergl.-Nr.	1225.1420
Beschreibung	Pumpe Eingang ø 63mm Ausgang ø 47mm Typ 1225.1420 230V 50Hz Phasen 1 1,1kW 1,5PS L 335mm Laufrichtung rechts Kondensator 31,5µF FIR		
Ersatzteile zu 500708			
	GEV-Nr.	365016	Vergl.-Nr. —
Betriebskondensator Kapazität 31,5µF 400V			
	GEV-Nr.	510602	Vergl.-Nr. 1225315/S
Laufrad ø 110mm H 34mm Laufrichtung rechts			
	GEV-Nr.	510693	Vergl.-Nr. N/A
Gleitringdichtung für Wellen ø 12mm			
	GEV-Nr.	524416	Vergl.-Nr. N/A
Pumpendeckeldichtung Materialstärke 4x4mm			



1

GEV-Nr.	500023	Vergl.-Nr.	1225.2725
Beschreibung	Pumpe Eingang ø 63mm Ausgang ø 47mm Typ 1225.2725 230/400V 50Hz Phasen 3 1,1kW 1,5PS L 335mm Laufrichtung rechts FIR		
Ersatzteile zu 500023			
	GEV-Nr.	510602	Vergl.-Nr. 1225315/S
Laufrad ø 110mm H 34mm Laufrichtung rechts			
	GEV-Nr.	510693	Vergl.-Nr. N/A
Gleitringdichtung für Wellen ø 12mm			

Tabellenfortsetzung auf der nächsten Seite

Ersatzteile zu 500023			
	GEV-Nr.	521513	Vergl.-Nr. N/A
Pumpendeckel FIR Eingang ø 63mm Ausgang ø 47mm			
	GEV-Nr.	524416	Vergl.-Nr. N/A
Pumpendeckeldichtung Materialstärke 4x4mm			







GEV-Nr.	499187	Vergl.-Nr.	1226.2530
Beschreibung	Pumpe Eingang ø 63mm Ausgang ø 47mm Typ 1226.2530 230/400V 50Hz Phasen 3 1,5kW 2PS L 335mm Laufrichtung rechts FIR		



GEV-Nr.	500742	Vergl.-Nr.	1226.2602
Beschreibung	Pumpe Eingang ø 63mm Ausgang ø 47mm Typ 1226.2602 230/400V 50Hz Phasen 3 1,5kW 2PS L 333mm Laufrichtung links FIR		



GEV-Nr.	500533	Vergl.-Nr.	1226.2820
Beschreibung	Pumpe Eingang ø 63mm Ausgang ø 47mm Typ 1226.2820 230/400V 50Hz Phasen 3 1,5kW 2PS L 335mm Laufrichtung rechts FIR		

Ersatzteile zu 500533			
	GEV-Nr.	510693	Vergl.-Nr. N/A
Gleitringdichtung für Wellen ø 12mm			
	GEV-Nr.	521215	Vergl.-Nr. N/A
Laufrad ø 118mm H 34mm Laufrichtung rechts			
	GEV-Nr.	521513	Vergl.-Nr. N/A
Pumpendeckel FIR Eingang ø 63mm Ausgang ø 47mm			
	GEV-Nr.	524416	Vergl.-Nr. N/A
Pumpendeckeldichtung Materialstärke 4x4mm			







GEV-Nr.	501513	Vergl.-Nr.	1227.2711M10
Beschreibung	Pumpe Eingang ø 63mm Ausgang ø 47mm Typ 1227.2711M10 230/400V 50Hz Phasen 3 1,7kW L 340mm Laufrichtung rechts FIR		





Ersatzteile zu 501513			
	GEV-Nr.	510693	Vergl.-Nr. N/A
Gleitringdichtung für Wellen ø 12mm			

Tabellenfortsetzung auf der nächsten Seite



Ersatzteile zu 501513				
	GEV-Nr.	511667	Vergl.-Nr.	—
Lüfferrad ø 123mm H 17mm Achsaufnahme ø 15mm				
	GEV-Nr.	521513	Vergl.-Nr.	N/A
Pumpendeckel FIR Eingang ø 63mm Ausgang ø 47mm				
	GEV-Nr.	524416	Vergl.-Nr.	N/A
Pumpendeckeldichtung Materialstärke 4x4mm				
	GEV-Nr.	698772	Vergl.-Nr.	N/A
Laufrad ø 113mm H 34mm M10L Pumpentyp 1227.2711M10				



1				
GEV-Nr.	500323	Vergl.-Nr.	1227.2721	
Beschreibung	Pumpe Eingang ø 63mm Ausgang ø 47mm Typ 1227.2721 230/400V 50Hz Phasen 3 2kW 2,7PS L 335mm Laufrichtung rechts FIR			
Ersatzteile zu 500323				
	GEV-Nr.	510599	Vergl.-Nr.	N/A
Laufrad ø 123mm H 34mm M8L				
	GEV-Nr.	510693	Vergl.-Nr.	N/A
Gleitringdichtung für Wellen ø 12mm				
	GEV-Nr.	521513	Vergl.-Nr.	N/A
Pumpendeckel FIR Eingang ø 63mm Ausgang ø 47mm				
	GEV-Nr.	524416	Vergl.-Nr.	N/A
Pumpendeckeldichtung Materialstärke 4x4mm				









1				
GEV-Nr.	500035	Vergl.-Nr.	1293.1402	
Beschreibung	Pumpe Eingang ø 63mm Ausgang ø 47mm Typ 1293.1402 230V 50Hz Phasen 1 0,55kW 0,75PS L 295mm Laufrichtung rechts Kondensator 12,5µF FIR Eingang ø 63mm Ausgang ø 48mm			
Ersatzteile zu 500035				
	GEV-Nr.	365014	Vergl.-Nr.	—
Betriebskondensator Kapazität 12,5µF 400V				
	GEV-Nr.	510601	Vergl.-Nr.	N/A
Laufrad ø 103mm H 25mm Laufrichtung rechts				
	GEV-Nr.	510693	Vergl.-Nr.	N/A
Gleitringdichtung für Wellen ø 12mm				
	GEV-Nr.	521513	Vergl.-Nr.	N/A
Pumpendeckel FIR Eingang ø 63mm Ausgang ø 47mm				
	GEV-Nr.	524416	Vergl.-Nr.	N/A
Pumpendeckeldichtung Materialstärke 4x4mm				



1				
GEV-Nr.	500325	Vergl.-Nr.	1293.1603	
Beschreibung	Pumpe Eingang ø 63mm Ausgang ø 47mm Typ 1293.1603 230V 50Hz Phasen 1 0,55kW 0,75PS L 300mm Laufrichtung rechts Kondensator 12,5µF FIR			
Ersatzteile zu 500325				
	GEV-Nr.	365014	Vergl.-Nr.	—
Betriebskondensator Kapazität 12,5µF 400V				

Tabellenfortsetzung auf der nächsten Seite

Ersatzteile zu 500325			
	GEV-Nr.	510601	Vergl.-Nr. N/A
Laufrad ø 103mm H 25mm Laufrichtung rechts			
	GEV-Nr.	510693	Vergl.-Nr. N/A
Gleitringdichtung für Wellen ø 12mm			
	GEV-Nr.	521513	Vergl.-Nr. N/A
Pumpendeckel FIR Eingang ø 63mm Ausgang ø 47mm			
	GEV-Nr.	524416	Vergl.-Nr. N/A
Pumpendeckeldichtung Materialstärke 4x4mm			

Ersatzteile zu 500034			
	GEV-Nr.	521513	Vergl.-Nr. N/A
Pumpendeckel FIR Eingang ø 63mm Ausgang ø 47mm			
	GEV-Nr.	524416	Vergl.-Nr. N/A
Pumpendeckeldichtung Materialstärke 4x4mm			



1

GEV-Nr.	499228	Vergl.-Nr.	1293.2725
Beschreibung	Pumpe Eingang ø 63mm Ausgang ø 47mm Typ 1293.2725 220-240/380-415V 50Hz Phasen 3 0,55kW L 302mm Laufrichtung rechts FIR		



1

GEV-Nr.	500257	Vergl.-Nr.	1295
Beschreibung	Pumpe Eingang ø 63mm Ausgang ø 47mm Typ 1295 230/400V 50Hz Phasen 3 0,88kW 1,2PS L 300mm Laufrichtung rechts FIR		
Zubehör zu	500257		
	GEV-Nr.	521213	Vergl.-Nr. N/A
Laufrad ø 117mm H 24mm M8L			



1

GEV-Nr.	500034	Vergl.-Nr.	1293.3500
Beschreibung	Pumpe Eingang ø 63mm Ausgang ø 47mm Typ 1293.3500 230/400V 50Hz Phasen 3 0,55kW 0,75PS L 300mm Laufrichtung rechts FIR		
Ersatzteile zu 500034			
	GEV-Nr.	510601	Vergl.-Nr. N/A
Laufrad ø 103mm H 25mm Laufrichtung rechts			
	GEV-Nr.	510693	Vergl.-Nr. N/A
Gleitringdichtung für Wellen ø 12mm			





1





GEV-Nr.	500330	Vergl.-Nr.	1295.1409
Beschreibung	Pumpe Eingang ø 63mm Ausgang ø 47mm Typ 1295.1409 230V 50Hz Phasen 1 0,88kW 1,2PS L 305mm Laufrichtung rechts Kondensator 12,5µF FIR		
Ersatzteile zu 500330			
	GEV-Nr.	365014	Vergl.-Nr. —
Betriebskondensator Kapazität 12,5µF 400V			
	GEV-Nr.	510693	Vergl.-Nr. N/A
Gleitringdichtung für Wellen ø 12mm			

Tabellenfortsetzung auf der nächsten Seite







Ersatzteile zu 500330			
	GEV-Nr.	521213	Vergl.-Nr. N/A
Laufrad ø 117mm H 24mm M8L			
	GEV-Nr.	521513	Vergl.-Nr. N/A
Pumpendeckel FIR Eingang ø 63mm Ausgang ø 47mm			
	GEV-Nr.	524416	Vergl.-Nr. N/A
Pumpendeckeldichtung Materialstärke 4x4mm			



1			
GEV-Nr.	500029	Vergl.-Nr.	1295.2502 1295.2503
Beschreibung	Pumpe Eingang ø 63mm Ausgang ø 47mm Typ 1295.2503 230/400V 50Hz Phasen 3 0,88kW 1,2PS L 305mm Laufrichtung rechts FIR		
Ersatzteile zu 500029			
	GEV-Nr.	510693	Vergl.-Nr. N/A
Gleitringdichtung für Wellen ø 12mm			
	GEV-Nr.	521213	Vergl.-Nr. N/A
Laufrad ø 117mm H 24mm M8L			
	GEV-Nr.	521513	Vergl.-Nr. N/A
Pumpendeckel FIR Eingang ø 63mm Ausgang ø 47mm			
	GEV-Nr.	524416	Vergl.-Nr. N/A
Pumpendeckeldichtung Materialstärke 4x4mm			





1			
GEV-Nr.	500706	Vergl.-Nr.	2237.2522
Beschreibung	Pumpe Eingang ø 63mm Ausgang ø 47mm Typ 2237.2522 230/400V 50Hz Phasen 3 2kW 2,7PS L 330mm Laufrichtung rechts FIR		
Ersatzteile zu 500706			
	GEV-Nr.	510599	Vergl.-Nr. N/A
Laufrad ø 123mm H 34mm M8L			
	GEV-Nr.	510693	Vergl.-Nr. N/A
Gleitringdichtung für Wellen ø 12mm			
	GEV-Nr.	521513	Vergl.-Nr. N/A
Pumpendeckel FIR Eingang ø 63mm Ausgang ø 47mm			
	GEV-Nr.	524416	Vergl.-Nr. N/A
Pumpendeckeldichtung Materialstärke 4x4mm			



1			
GEV-Nr.	500570	Vergl.-Nr.	422512725
Beschreibung	Pumpe Eingang ø 63mm Ausgang ø 47mm Typ 422512725 230/400V 50Hz Phasen 3 1,1kW 1,5PS L 285mm Laufrichtung rechts FIR		
Ersatzteile zu 500570			
	GEV-Nr.	510693	Vergl.-Nr. N/A
Gleitringdichtung für Wellen ø 12mm			
	GEV-Nr.	521082	Vergl.-Nr. N/A
Laufrad ø 96mm H 32mm Laufrichtung rechts			

Tabellenfortsetzung auf der nächsten Seite



Ersatzteile zu 500570			
	GEV-Nr.	521513	Vergl.-Nr. N/A
Pumpendeckel FIR Eingang ø 63mm Ausgang ø 47mm			
	GEV-Nr.	524416	Vergl.-Nr. N/A
Pumpendeckeldichtung Materialstärke 4x4mm			



GEV-Nr.	499283	Vergl.-Nr.	422512760
Beschreibung	Pumpe Eingang ø 63mm Ausgang ø 47mm Typ 422512760 230/400V 60Hz Phasen 3 1,1kW L 290mm Laufrichtung rechts FIR		







GEV-Nr.	500117	Vergl.-Nr.	1226 422522725
Beschreibung	Pumpe Eingang ø 63mm Ausgang ø 47mm Typ 422522725 230/400V 50Hz Phasen 3 1,4kW 2PS L 280mm Laufrichtung rechts FIR		

Ersatzteile zu 500117			
	GEV-Nr.	510602	Vergl.-Nr. 1225315/S
Lauftrad ø 110mm H 34mm Laufrichtung rechts			
	GEV-Nr.	510693	Vergl.-Nr. N/A
Gleitringdichtung für Wellen ø 12mm			
	GEV-Nr.	521513	Vergl.-Nr. N/A
Pumpendeckel FIR Eingang ø 63mm Ausgang ø 47mm			

Ersatzteile zu 500117			
	GEV-Nr.	524416	Vergl.-Nr. N/A
Pumpendeckeldichtung Materialstärke 4x4mm			



GEV-Nr.	501540	Vergl.-Nr.	422522726
Beschreibung	Pumpe Eingang ø 63mm Ausgang ø 47mm Typ 422522726 230/400V 50Hz Phasen 3 1,4kW 2PS L 280mm Laufrichtung rechts FIR		

Ersatzteile zu 501540			
	GEV-Nr.	510602	Vergl.-Nr. 1225315/S
Lauftrad ø 110mm H 34mm Laufrichtung rechts			
	GEV-Nr.	510693	Vergl.-Nr. N/A
Gleitringdichtung für Wellen ø 12mm			
	GEV-Nr.	521513	Vergl.-Nr. N/A
Pumpendeckel FIR Eingang ø 63mm Ausgang ø 47mm			
	GEV-Nr.	524416	Vergl.-Nr. N/A
Pumpendeckeldichtung Materialstärke 4x4mm			



GEV-Nr.	499280	Vergl.-Nr.	5295.5050
Beschreibung	Pumpe Eingang ø 63mm Ausgang ø 47mm Typ 5295.5050 230/400V 50Hz Phasen 3 1,5kW L 300mm Laufrichtung rechts FIR		

Ersatzteile zu 499280			
	GEV-Nr.	502277	Vergl.-Nr. N/A
Lauftrad ø 111mm H 31mm Gewinde M8L			

Tabellenfortsetzung auf der nächsten Seite



Ersatzteile zu 499280			
	GEV-Nr.	510693	Vergl.-Nr. N/A
Gleitringdichtung für Wellen ø 12mm			
	GEV-Nr.	521022	Vergl.-Nr. —
Lüfterradabdeckung ID ø 137mm AD ø 142mm H 70mm			
	GEV-Nr.	524416	Vergl.-Nr. N/A
Pumpendeckeldichtung Materialstärke 4x4mm			
	GEV-Nr.	698773	Vergl.-Nr. N/A
Pumpendeckel Eingang ø 63mm Ausgang ø 47mm			



1			
GEV-Nr.	501452	Vergl.-Nr.	1204
Beschreibung	Pumpe Eingang ø 63mm Ausgang ø 53mm Typ 1204 220-240V 50Hz Phasen 1 1,5kW 2PS L 34mm Kondensator internµF FIR		
Ersatzteile zu	501452		
	GEV-Nr.	510531	Vergl.-Nr. N/A
Pumpendeckel FIR Eingang ø 63mm Ausgang ø 53mm			
	GEV-Nr.	510604	Vergl.-Nr. N/A
Laufrad ø 118mm H 34mm M8R Laufrichtung links			
	GEV-Nr.	510693	Vergl.-Nr. N/A
Gleitringdichtung für Wellen ø 12mm			
	GEV-Nr.	524416	Vergl.-Nr. N/A
Pumpendeckeldichtung Materialstärke 4x4mm			



1			
GEV-Nr.	501457	Vergl.-Nr.	1204
Beschreibung	Pumpe Eingang ø 63mm Ausgang ø 53mm Typ 1204 230/400V 50Hz Phasen 3 1,5kW 2PS L 328mm Laufrichtung links FIR		
Ersatzteile zu	501457		
	GEV-Nr.	502013	Vergl.-Nr. N/A
Pumpendeckel FIR Eingang ø 63mm Ausgang ø 53mm			
	GEV-Nr.	510604	Vergl.-Nr. N/A
Laufrad ø 118mm H 34mm M8R Laufrichtung links			
	GEV-Nr.	510693	Vergl.-Nr. N/A
Gleitringdichtung für Wellen ø 12mm			
	GEV-Nr.	524416	Vergl.-Nr. N/A
Pumpendeckeldichtung Materialstärke 4x4mm			



1			
GEV-Nr.	500018	Vergl.-Nr.	1204.2528
Beschreibung	Pumpe Eingang ø 63mm Ausgang ø 53mm Typ 1204.2528 230/400V 50Hz Phasen 3 1,5kW 2PS L 328mm Laufrichtung links FIR		
Ersatzteile zu	500018		
	GEV-Nr.	510523	Vergl.-Nr. —
Lüfterrad ø 142mm Achsaufnahme ø 15mm Schaufeln 12			
	GEV-Nr.	510531	Vergl.-Nr. N/A
Pumpendeckel FIR Eingang ø 63mm Ausgang ø 53mm			

Tabellenfortsetzung auf der nächsten Seite

Ersatzteile zu	500018		
	GEV-Nr.	510604	Vergl.-Nr. N/A
	Laufrad ø 118mm H 34mm M8R Laufrichtung links		
	GEV-Nr.	510693	Vergl.-Nr. N/A
	Gleitringdichtung für Wellen ø 12mm		
	GEV-Nr.	524416	Vergl.-Nr. N/A
	Pumpendeckeldichtung Materialstärke 4x4mm		



GEV-Nr.	500258	Vergl.-Nr.	1204.2725
Beschreibung	Pumpe Eingang ø 63mm Ausgang ø 53mm Typ 1204.2725 230/400V 50Hz Phasen 3 1,5kW 2,01PS L 320mm Laufrichtung links FIR		
Ersatzteile zu	500258		
	GEV-Nr.	510531	Vergl.-Nr. N/A
	Pumpendeckel FIR Eingang ø 63mm Ausgang ø 53mm		
	GEV-Nr.	510604	Vergl.-Nr. N/A
	Laufrad ø 118mm H 34mm M8R Laufrichtung links		
	GEV-Nr.	510693	Vergl.-Nr. N/A
	Gleitringdichtung für Wellen ø 12mm		
	GEV-Nr.	511667	Vergl.-Nr. —
	Lüfterrad ø 123mm H 17mm Achsaufnahme ø 15mm		
	GEV-Nr.	524416	Vergl.-Nr. N/A
	Pumpendeckeldichtung Materialstärke 4x4mm		



GEV-Nr.	499152	Vergl.-Nr.	1205.2502
Beschreibung	Pumpe Eingang ø 63mm Ausgang ø 53mm Typ 1205.2502 230/400V 50Hz Phasen 3 2kW 2,7PS L 328mm Laufrichtung links Hilfsdruck 10mm FIR		



GEV-Nr.	500031	Vergl.-Nr.	1205.2528
Beschreibung	Pumpe Eingang ø 63mm Ausgang ø 53mm Typ 1205.2528 230/400V 50Hz Phasen 3 2kW 2,7PS L 330mm Laufrichtung links FIR		
Ersatzteile zu	500031		
	GEV-Nr.	510357	Vergl.-Nr. N/A
	Laufrad ø 124mm H 34/16mm Gewinde M8R Schaufeln 6		
	GEV-Nr.	510523	Vergl.-Nr. —
	Lüfterrad ø 142mm Achsaufnahme ø 15mm Schaufeln 12		
	GEV-Nr.	510531	Vergl.-Nr. N/A
	Pumpendeckel FIR Eingang ø 63mm Ausgang ø 53mm		
	GEV-Nr.	510693	Vergl.-Nr. N/A
	Gleitringdichtung für Wellen ø 12mm		
	GEV-Nr.	524416	Vergl.-Nr. N/A
	Pumpendeckeldichtung Materialstärke 4x4mm		







1

GEV-Nr.	499297	Vergl.-Nr.	1205.2820
Beschreibung	Pumpe Eingang ø 63mm Ausgang ø 53mm Typ 1205.2820 230/400V 50Hz Phasen 3 2,7PS L 330mm Laufrichtung links FIR		
Ersatzteile zu	499297		
	GEV-Nr.	510357	Vergl.-Nr. N/A
	Laufrad ø 124mm H 34/16mm Gewinde M8R Schaufeln 6		
	GEV-Nr.	510523	Vergl.-Nr. —
	Lüfterrad ø 142mm Achsaufnahme ø 15mm Schaufeln 12		
	GEV-Nr.	510531	Vergl.-Nr. N/A
	Pumpendeckel FIR Eingang ø 63mm Ausgang ø 53mm		
	GEV-Nr.	510693	Vergl.-Nr. N/A
	Gleitringdichtung für Wellen ø 12mm		
	GEV-Nr.	524416	Vergl.-Nr. N/A
	Pumpendeckeldichtung Materialstärke 4x4mm		



1

GEV-Nr.	500111	Vergl.-Nr.	1241.2500 1241.2530
Beschreibung	Pumpe Eingang ø 63mm Ausgang ø 53mm Typ 1241.2500 230/400V 50Hz Phasen 3 1,1kW 1,5PS L 330mm Laufrichtung links FIR		
Ersatzteile zu	500111		
	GEV-Nr.	510531	Vergl.-Nr. N/A
	Pumpendeckel FIR Eingang ø 63mm Ausgang ø 53mm		
	GEV-Nr.	510612	Vergl.-Nr. N/A
	Laufrad ø 110mm H 34mm M8R		

Ersatzteile zu	500111		
	GEV-Nr.	510693	Vergl.-Nr. N/A
	Gleitringdichtung für Wellen ø 12mm		
	GEV-Nr.	524416	Vergl.-Nr. N/A
	Pumpendeckeldichtung Materialstärke 4x4mm		



1

GEV-Nr.	499237	Vergl.-Nr.	1241.2503
Beschreibung	Pumpe Eingang ø 63mm Ausgang ø 53mm Typ 1241.2503 230/400V 50Hz Phasen 3 1,1kW 1,5PS L 330mm Laufrichtung links FIR		



1

GEV-Nr.	500271	Vergl.-Nr.	1241.2708
Beschreibung	Pumpe Eingang ø 63mm Ausgang ø 53mm Typ 1241.2708 230/400V 50Hz Phasen 3 1,12kW 1,52PS L 330mm Laufrichtung links FIR		
Ersatzteile zu	500271		
	GEV-Nr.	510531	Vergl.-Nr. N/A
	Pumpendeckel FIR Eingang ø 63mm Ausgang ø 53mm		
	GEV-Nr.	510612	Vergl.-Nr. N/A
	Laufrad ø 110mm H 34mm M8R		
	GEV-Nr.	510693	Vergl.-Nr. N/A
	Gleitringdichtung für Wellen ø 12mm		
	GEV-Nr.	524416	Vergl.-Nr. N/A
	Pumpendeckeldichtung Materialstärke 4x4mm		



1

GEV-Nr.	500277	Vergl.-Nr.	1241.2720
Beschreibung	Pumpe Eingang ø 63mm Ausgang ø 53mm Typ 1241.2720 230/400V 50Hz Phasen 3 1,1kW 1,5PS L 335mm Laufrichtung links FIR		
Ersatzteile zu	500277		
	GEV-Nr.	502013	Vergl.-Nr. N/A
	Pumpendeckel FIR Eingang ø 63mm Ausgang ø 53mm		
	GEV-Nr.	510612	Vergl.-Nr. N/A
	Laufrad ø 110mm H 34mm M8R		
	GEV-Nr.	510693	Vergl.-Nr. N/A
	Gleitringdichtung für Wellen ø 12mm		
	GEV-Nr.	524416	Vergl.-Nr. N/A
	Pumpendeckeldichtung Materialstärke 4x4mm		



1

GEV-Nr.	501463	Vergl.-Nr.	1241.2780
Beschreibung	Pumpe Eingang ø 63mm Ausgang ø 53mm Typ 1241.2780 230/400V 50Hz Phasen 3 1,1kW 1,5PS L 335mm Laufrichtung links FIR		
Ersatzteile zu	501463		
	GEV-Nr.	502013	Vergl.-Nr. N/A
	Pumpendeckel FIR Eingang ø 63mm Ausgang ø 53mm		
	GEV-Nr.	510523	Vergl.-Nr. —
	Lüfterrad ø 142mm Achsaufnahme ø 15mm Schaufeln 12		

Ersatzteile zu	501463		
	GEV-Nr.	510612	Vergl.-Nr. N/A
	Laufrad ø 110mm H 34mm M8R		
	GEV-Nr.	510693	Vergl.-Nr. N/A
	Gleitringdichtung für Wellen ø 12mm		
	GEV-Nr.	524416	Vergl.-Nr. N/A
	Pumpendeckeldichtung Materialstärke 4x4mm		



1

GEV-Nr.	500119	Vergl.-Nr.	1241.4701
Beschreibung	Pumpe Eingang ø 63mm Ausgang ø 53mm Typ 1241.4701 230V 50Hz Phasen 1 1,1kW 1,5PS L 330mm Laufrichtung links Kondensator 31,5µF FIR		
Ersatzteile zu	500119		
	GEV-Nr.	365016	Vergl.-Nr. —
	Betriebskondensator Kapazität 31,5µF 400V		
	GEV-Nr.	510531	Vergl.-Nr. N/A
	Pumpendeckel FIR Eingang ø 63mm Ausgang ø 53mm		
	GEV-Nr.	510612	Vergl.-Nr. N/A
	Laufrad ø 110mm H 34mm M8R		
	GEV-Nr.	510693	Vergl.-Nr. N/A
	Gleitringdichtung für Wellen ø 12mm		
	GEV-Nr.	524416	Vergl.-Nr. N/A
	Pumpendeckeldichtung Materialstärke 4x4mm		



1			
GEV-Nr.	501459	Vergl.-Nr.	1241/1
Beschreibung	Pumpe Eingang ø 63mm Ausgang ø 53mm Typ 1241/1 230/240V 50Hz Phasen 1 1,1kW 1,5PS L 330mm Laufrichtung links Kondensator 31,5µF FIR		
Ersatzteile zu	501459		
	GEV-Nr.	365016	Vergl.-Nr. —
	Betriebskondensator Kapazität 31,5µF 400V		
	GEV-Nr.	502013	Vergl.-Nr. N/A
	Pumpendeckel FIR Eingang ø 63mm Ausgang ø 53mm		
	GEV-Nr.	510612	Vergl.-Nr. N/A
	Laufrad ø 110mm H 34mm M8R		
	GEV-Nr.	510693	Vergl.-Nr. N/A
	Gleitringdichtung für Wellen ø 12mm		
	GEV-Nr.	524416	Vergl.-Nr. N/A
	Pumpendeckeldichtung Materialstärke 4x4mm		



1			
GEV-Nr.	499197	Vergl.-Nr.	1243
Beschreibung	Pumpe Eingang ø 63mm Ausgang ø 53mm Typ 1243 255/440V 60Hz Phasen 3 3,2PS L 370mm Laufrichtung links FIR		



1			
GEV-Nr.	500324	Vergl.-Nr.	1243.2520 1243.2591
Beschreibung	Pumpe Eingang ø 63mm Ausgang ø 53mm Typ 1243.2591 230/400V 50Hz Phasen 3 2,35kW 3,2PS L 365mm Laufrichtung links FIR		
Ersatzteile zu	500324		
	GEV-Nr.	510357	Vergl.-Nr. N/A
	Laufrad ø 124mm H 34/16mm Gewinde M8R Schaufeln 6		
	GEV-Nr.	510531	Vergl.-Nr. N/A
	Pumpendeckel FIR Eingang ø 63mm Ausgang ø 53mm		
	GEV-Nr.	510693	Vergl.-Nr. N/A
	Gleitringdichtung für Wellen ø 12mm		
	GEV-Nr.	524416	Vergl.-Nr. N/A
	Pumpendeckeldichtung Materialstärke 4x4mm		



1			
GEV-Nr.	500705	Vergl.-Nr.	1243.2700
Beschreibung	Pumpe Eingang ø 63mm Ausgang ø 53mm Typ 1243 230/400V 50Hz Phasen 3 2,39kW 3,2PS L 363mm Laufrichtung links FIR		
Ersatzteile zu	500705		
	GEV-Nr.	510357	Vergl.-Nr. N/A
	Laufrad ø 124mm H 34/16mm Gewinde M8R Schaufeln 6		



1

GEV-Nr.	500952	Vergl.-Nr.	1244.2527
Beschreibung	Pumpe Eingang ø 63mm Ausgang ø 53mm Typ 1244.2527 400V 50Hz Phasen 3 2,5kW 3,5PS L 360mm Laufrichtung links FIR		
Ersatzteile zu	500952		
	GEV-Nr.	510357	Vergl.-Nr. N/A
	Laufrad ø 124mm H 34/16mm Gewinde M8R Schaufeln 6		
	GEV-Nr.	510531	Vergl.-Nr. N/A
	Pumpendeckel FIR Eingang ø 63mm Ausgang ø 53mm		
	GEV-Nr.	510693	Vergl.-Nr. N/A
	Gleitringdichtung für Wellen ø 12mm		
	GEV-Nr.	524416	Vergl.-Nr. N/A
	Pumpendeckeldichtung Materialstärke 4x4mm		



1

GEV-Nr.	501462	Vergl.-Nr.	2204/D
Beschreibung	Pumpe Eingang ø 63mm Ausgang ø 53mm Typ 2204/D 230V 50Hz Phasen 1 0,73kW 1PS L 260mm Laufrichtung links Kondensator 20µFµF FIR		
Ersatzteile zu	501462		
	GEV-Nr.	365019	Vergl.-Nr. —
	Betriebskondensator Kapazität 20µF 400V		
	GEV-Nr.	502013	Vergl.-Nr. N/A
	Pumpendeckel FIR Eingang ø 63mm Ausgang ø 53mm		

Ersatzteile zu	501462		
	GEV-Nr.	510693	Vergl.-Nr. N/A
	Gleitringdichtung für Wellen ø 12mm		
	GEV-Nr.	521219	Vergl.-Nr. N/A
	Laufrad ø 106mm H 27mm Gewinde M8R Welle ø 28mm		
	GEV-Nr.	524416	Vergl.-Nr. N/A
	Pumpendeckeldichtung Materialstärke 4x4mm		



1

GEV-Nr.	500276	Vergl.-Nr.	2204D1520
Beschreibung	Pumpe Eingang ø 63mm Ausgang ø 53mm Typ 2204D1520 230V 50Hz Phasen 1 0,73kW 1PS L 260mm Laufrichtung links Kondensator 20µFµF FIR		
Ersatzteile zu	500276		
	GEV-Nr.	365019	Vergl.-Nr. —
	Betriebskondensator Kapazität 20µF 400V		
	GEV-Nr.	502013	Vergl.-Nr. N/A
	Pumpendeckel FIR Eingang ø 63mm Ausgang ø 53mm		
	GEV-Nr.	510693	Vergl.-Nr. N/A
	Gleitringdichtung für Wellen ø 12mm		
	GEV-Nr.	521219	Vergl.-Nr. N/A
	Laufrad ø 106mm H 27mm Gewinde M8R Welle ø 28mm		
	GEV-Nr.	524416	Vergl.-Nr. N/A
	Pumpendeckeldichtung Materialstärke 4x4mm		
	GEV-Nr.	524845	Vergl.-Nr. —
	Lüfterrad ø 116mm Achsaufnahme ø 9,7mm Kunststoff		



1			
GEV-Nr.	500058	Vergl.-Nr.	2241.2500
Beschreibung	Pumpe Eingang ø 63mm Ausgang ø 53mm Typ 2241.2500 230/400V 50Hz Phasen 3 0,89kW 1,2PS L 305mm Laufrichtung links FIR		
Ersatzteile zu	500058		
	GEV-Nr.	510531	Vergl.-Nr. N/A
	Pumpendeckel FIR Eingang ø 63mm Ausgang ø 53mm		
	GEV-Nr.	510693	Vergl.-Nr. N/A
	Gleitringdichtung für Wellen ø 12mm		
	GEV-Nr.	510834	Vergl.-Nr. N/A
	Laufgrad ø 110mm H 29mm Gewinde M8R passend für FIR		
	GEV-Nr.	524416	Vergl.-Nr. N/A
	Pumpendeckeldichtung Materialstärke 4x4mm		
Zubehör zu	500058		
	GEV-Nr.	524046	Vergl.-Nr. —
	Schwingungsdämpfer L 40mm B 25mm H 25mm für Pumpe		



1			
GEV-Nr.	499293	Vergl.-Nr.	2241.2703
Beschreibung	Pumpe Eingang ø 63mm Ausgang ø 53mm Typ 2241.2703 230/400V 50Hz Phasen 3 0,89kW 1,2PS L 300mm Laufrichtung links FIR		



1			
GEV-Nr.	499193	Vergl.-Nr.	2241.5800
Beschreibung	Pumpe Eingang ø 63mm Ausgang ø 53mm Typ 2241.5800 255/440V 60Hz Phasen 3 1,1kW L 305mm Laufrichtung links FIR		





1			
GEV-Nr.	501467	Vergl.-Nr.	2241.2501
Beschreibung	Pumpe Eingang ø 63mm Ausgang ø 53mm Typ 2241.2501 230/400V 50Hz Phasen 3 0,89kW 1,5PS L 305mm Laufrichtung links FIR		



1			
GEV-Nr.	499108	Vergl.-Nr.	4205.2701 4205.2702
Beschreibung	Pumpe Eingang ø 63mm Ausgang ø 53mm Typ 4205.2702 230/400V 50Hz Phasen 3 1,38kW 1,85PS L 330mm Laufrichtung links FIR		
Ersatzteile zu	499108		
	GEV-Nr.	502013	Vergl.-Nr. N/A
	Pumpendeckel FIR Eingang ø 63mm Ausgang ø 53mm		

Tabellenfortsetzung auf der nächsten Seite



Ersatzteile zu	499108		
	GEV-Nr.	502122	Vergl.-Nr. N/A
	Laufrad ø 119mm H 33mm M8R		
	GEV-Nr.	510693	Vergl.-Nr. N/A
	Gleitringdichtung für Wellen ø 12mm		
	GEV-Nr.	524416	Vergl.-Nr. N/A
	Pumpendeckeldichtung Materialstärke 4x4mm		



1

GEV-Nr.	499251	Vergl.-Nr.	5223.2350
Beschreibung	Pumpe Eingang ø 63mm Ausgang ø 53mm Typ 5223.2350 230V 50Hz Phasen 1 0,74kW L 314mm Laufrichtung links Kondensator 16µF FIR		
Ersatzteile zu	499251		
	GEV-Nr.	365021	Vergl.-Nr. —
	Betriebskondensator Kapazität 16µF 425V		
	GEV-Nr.	502274	Vergl.-Nr. N/A
	Pumpendeckel FIR Eingang ø 63mm Ausgang ø 53mm		
	GEV-Nr.	502275	Vergl.-Nr. N/A
	Laufrad ø 100mm H 29mm Gewinde M8R Schaufeln 6		
	GEV-Nr.	510693	Vergl.-Nr. N/A
	Gleitringdichtung für Wellen ø 12mm		
	GEV-Nr.	521022	Vergl.-Nr. —
	Lüfterradabdeckung ID ø 137mm AD ø 142mm H 70mm		
	GEV-Nr.	524416	Vergl.-Nr. N/A
	Pumpendeckeldichtung Materialstärke 4x4mm		



1

GEV-Nr.	499300	Vergl.-Nr.	5223.4050
Beschreibung	Pumpe Eingang ø 63mm Ausgang ø 53mm Typ 5223.4050 230/400V 50Hz Phasen 3 1,1kW L 316mm Laufrichtung links FIR		



1

GEV-Nr.	499109	Vergl.-Nr.	5233.4051
Beschreibung	Pumpe Eingang ø 63mm Ausgang ø 53mm Typ 5233.4051 220-240/380-415V 50Hz Phasen 3 1,1kW 1,5PS L 345mm Laufrichtung links FIR		
Ersatzteile zu	499109		
	GEV-Nr.	502274	Vergl.-Nr. N/A
	Pumpendeckel FIR Eingang ø 63mm Ausgang ø 53mm		
	GEV-Nr.	510612	Vergl.-Nr. N/A
	Laufrad ø 110mm H 34mm M8R		
	GEV-Nr.	510693	Vergl.-Nr. N/A
	Gleitringdichtung für Wellen ø 12mm		
	GEV-Nr.	524416	Vergl.-Nr. N/A
	Pumpendeckeldichtung Materialstärke 4x4mm		



GEV-Nr.	499113	Vergl.-Nr.	5234.4050
Beschreibung	Pumpe Eingang ø 63mm Ausgang ø 53mm Typ 5234.4050 230/400V 50Hz Phasen 3 1,62kW 2,2PS L 340mm Laufrichtung links FIR		



GEV-Nr.	499115	Vergl.-Nr.	5234.4052
Beschreibung	Pumpe Eingang ø 63mm Ausgang ø 53mm Typ 5234.4052 230/400V 50Hz Phasen 3 1,62kW L 340mm Laufrichtung links FIR		



GEV-Nr.	500741	Vergl.-Nr.	5234.4055
Beschreibung	Pumpe Eingang ø 63mm Ausgang ø 53mm Typ 5234.4055 230/400V 50Hz Phasen 3 1,5kW 2PS L 340mm Laufrichtung links FIR		

Ersatzteile zu	500741		
	GEV-Nr.	502274	Vergl.-Nr. N/A
	Pumpendeckel FIR Eingang ø 63mm Ausgang ø 53mm		
	GEV-Nr.	510604	Vergl.-Nr. N/A
	Laufrad ø 118mm H 34mm M8R Laufrichtung links		

Ersatzteile zu	500741		
	GEV-Nr.	510693	Vergl.-Nr. N/A
	Gleitringdichtung für Wellen ø 12mm		
	GEV-Nr.	524416	Vergl.-Nr. N/A
	Pumpendeckeldichtung Materialstärke 4x4mm		



GEV-Nr.	500244	Vergl.-Nr.	1241.2725
Beschreibung	Pumpe Eingang ø 63mm Ausgang ø 54mm Typ 1241.2725 230/400V Phasen 3 1,1kW 1,5PS Laufrichtung links FIR		

Ersatzteile zu	500244		
	GEV-Nr.	510531	Vergl.-Nr. N/A
	Pumpendeckel FIR Eingang ø 63mm Ausgang ø 53mm		
	GEV-Nr.	510612	Vergl.-Nr. N/A
	Laufrad ø 110mm H 34mm M8R		
	GEV-Nr.	510693	Vergl.-Nr. N/A
	Gleitringdichtung für Wellen ø 12mm		
	GEV-Nr.	524416	Vergl.-Nr. N/A
	Pumpendeckeldichtung Materialstärke 4x4mm		





GEV-Nr.	500397	Vergl.-Nr.	2254.1000
Beschreibung	Pumpe Eingang ø 70mm Ausgang ø 60mm Typ 2254.1000 230/400V 50Hz Phasen 3 1,1kW 1,5PS L 320mm Laufrichtung rechts FIR		

Ersatzteile zu	500397		
	GEV-Nr.	510693	Vergl.-Nr. N/A
	Gleitringdichtung für Wellen ø 12mm		

Tabellenfortsetzung auf der nächsten Seite







Ersatzteile zu 500397			
	GEV-Nr.	521216	Vergl.-Nr. N/A
Laufrad ø 100mm H 31mm M8L			
	GEV-Nr.	521515	Vergl.-Nr. N/A
Pumpendeckel Eingang ø 70mm Ausgang ø 60mm			
	GEV-Nr.	524416	Vergl.-Nr. N/A
Pumpendeckeldichtung Materialstärke 4x4mm			



1			
GEV-Nr.	500115	Vergl.-Nr.	2254.2560 2254.2561
Beschreibung	Pumpe Eingang ø 70mm Ausgang ø 60mm Typ 2254.2561 230/400V 50Hz Phasen 3 1,5kW 2PS L 325mm Laufrichtung rechts FIR		
Ersatzteile zu 500115			
	GEV-Nr.	504313	Vergl.-Nr. —
Schlauchanschluss Gewinde M12x1,75 Tülle ø 11,3mm			
	GEV-Nr.	510693	Vergl.-Nr. N/A
Gleitringdichtung für Wellen ø 12mm			
	GEV-Nr.	521014	Vergl.-Nr. N/A
Laufrad ø 110mm H 32mm Laufrichtung rechts			
	GEV-Nr.	521515	Vergl.-Nr. N/A
Pumpendeckel Eingang ø 70mm Ausgang ø 60mm			
	GEV-Nr.	524416	Vergl.-Nr. N/A
Pumpendeckeldichtung Materialstärke 4x4mm			





1			
GEV-Nr.	499264	Vergl.-Nr.	2254.2562
Beschreibung	Pumpe Eingang ø 70mm Ausgang ø 60mm Typ 2254.2562 220-240/380-415V 50Hz Phasen 3 1,5kW L 322mm Laufrichtung rechts FIR		
Ersatzteile zu 499264			
	GEV-Nr.	510694	Vergl.-Nr. —
Gleitringdichtung für Wellen ø 13mm			
	GEV-Nr.	521014	Vergl.-Nr. N/A
Laufrad ø 110mm H 32mm Laufrichtung rechts			
	GEV-Nr.	521515	Vergl.-Nr. N/A
Pumpendeckel Eingang ø 70mm Ausgang ø 60mm			
	GEV-Nr.	524416	Vergl.-Nr. N/A
Pumpendeckeldichtung Materialstärke 4x4mm			



1			
GEV-Nr.	499265	Vergl.-Nr.	2254.5881
Beschreibung	Pumpe Eingang ø 70mm Ausgang ø 60mm Typ 2254.5881 255/440V 60Hz Phasen 3 1,5kW L 322mm Laufrichtung rechts FIR		
Ersatzteile zu 499265			
	GEV-Nr.	502276	Vergl.-Nr. N/A
Laufrad ø 90mm H 30mm Gewinde M8L			
	GEV-Nr.	504313	Vergl.-Nr. —
Schlauchanschluss Gewinde M12x1,75 Tülle ø 11,3mm			
	GEV-Nr.	510693	Vergl.-Nr. N/A
Gleitringdichtung für Wellen ø 12mm			

Tabellenfortsetzung auf der nächsten Seite







Ersatzteile zu 499265			
	GEV-Nr.	521515	Vergl.-Nr. N/A
Pumpendeckel Eingang ø 70mm Ausgang ø 60mm			
	GEV-Nr.	524416	Vergl.-Nr. N/A
Pumpendeckeldichtung Materialstärke 4x4mm			



GEV-Nr.	500012	Vergl.-Nr.	1243
Beschreibung	Pumpe Typ 1243 50Hz Laufrichtung links FIR		



GEV-Nr.	500259	Vergl.-Nr.	2212.1400
Beschreibung	Pumpe Typ 2212.1400 230V 50Hz Phasen 1 0,075kW 0,1PS Laufrichtung rechts FIR		

Ersatzteile zu 500259			
	GEV-Nr.	365017	Vergl.-Nr. —
Betriebskondensator Kapazität 5µF 450V			
	GEV-Nr.	510510	Vergl.-Nr. X2212-HP,0,10_(1)
Pumpendeckel Pumpentyp 2212/2228/2229/2211			
	GEV-Nr.	510695	Vergl.-Nr. N/A
Gleitringdichtung Höhe Gegenring 5,5mm			
	GEV-Nr.	521203	Vergl.-Nr. N/A
Laufrad ø 72mm H 18mm Gewinde M7 Welle ø 11mm			
	GEV-Nr.	521703	Vergl.-Nr. N/A
Pumpendeckeldichtung EPDM Materialstärke 2,5mm			



GEV-Nr.	500326	Vergl.-Nr.	3911
Beschreibung	Pumpe Typ 3911 230V 50Hz Phasen 1 0,55kW 0,75PS Laufrichtung rechts FIR		





GEV-Nr.	500026	Vergl.-Nr.	3942
Beschreibung	Pumpe Typ 3942 230V 50Hz Phasen 1 0,55kW 0,75PS Laufrichtung rechts FIR		



GEV-Nr.	500698	Vergl.-Nr.	4273.2350
Beschreibung	Pumpe Typ 4273.2350 230V 50Hz Phasen 1 0,55kW 0,75PS L 170mm Laufrichtung links Kondensator 12,5µF FIR		
Ersatzteile zu 500698			
	GEV-Nr.	365014	Vergl.-Nr. —
Betriebskondensator Kapazität 12,5µF 400V			

Tabellenfortsetzung auf der nächsten Seite

Ersatzteile zu 500698			
	GEV-Nr.	510695	Vergl.-Nr. N/A
Gleitringdichtung Höhe Gegenring 5,5mm			
	GEV-Nr.	512437	Vergl.-Nr. —
Laufrad ø 85mm H 27mm Laufrichtung rechts			

Ersatzteile und Zubehör

Gleitringdichtungen

			
1			
GEV-Nr.	510692	Vergl.-Nr.	N/A
Beschreibung	Gleitringdichtung für Wellen ø 11mm Gleitring AD ø 24mm Gleitring H 13mm Gegenring Einbau ø 26mm Höhe Gegenring 8mm Gegenring Innen-ø 14mm Edelstahl/Keramik/EPDM		

			
1			
GEV-Nr.	510693	Vergl.-Nr.	N/A
Beschreibung	Gleitringdichtung für Wellen ø 12mm Gleitring AD ø 24mm Gleitring H 15,5mm Gleitring Innen-ø 11mm Gegenring Einbau ø 24mm Höhe Gegenring 8mm Gegenring Innen-ø 14mm Edelstahl/Keramik/EPDM		

			
1			
GEV-Nr.	510703	Vergl.-Nr.	N/A
Beschreibung	Gleitringdichtung für Wellen ø 13mm Gleitring H 13mm Höhe Gegenring 5,5mm Edelstahl/Keramik/EPDM AD ø 26mm		

			
1			
GEV-Nr.	510687	Vergl.-Nr.	N/A
Beschreibung	Gleitringdichtung für Wellen ø 18mm Höhe Gegenring 8mm ID ø 17mm AD ø 39mm H 15mm Einbau ø 42mm Innen-ø 1 21mm		

			
1			
GEV-Nr.	510690	Vergl.-Nr.	N/A
Beschreibung	Gleitringdichtung für Wellen ø 8mm Edelstahl/Keramik/EPDM AD ø 24mm Einbau ø 24/26mm		

			
1			
GEV-Nr.	510695	Vergl.-Nr.	N/A
Beschreibung	Gleitringdichtung Höhe Gegenring 5,5mm Edelstahl/Keramik/EPDM ID ø 11mm		

			
1			
GEV-Nr.	510702	Vergl.-Nr.	N/A
Beschreibung	Gleitringdichtung Höhe Gegenring 5,5mm Edelstahl/Keramik/EPDM ID ø 12mm		

Laufräder

			
1			
GEV-Nr.	502275	Vergl.-Nr.	N/A
Beschreibung	Laufrad ø 100mm H 29mm Gewinde M8R Schaufeln 6		

			
1			
GEV-Nr.	521216	Vergl.-Nr.	N/A
Beschreibung	Laufrad ø 100mm H 31mm M8L		

			
1			
GEV-Nr.	510600	Vergl.-Nr.	N/A
Beschreibung	Laufrad ø 102mm H 29mm Achsaufnahme ø 9/8mm Laufrichtung rechts Schaufeln 6		



			
1			
GEV-Nr.	510601	Vergl.-Nr.	N/A
Beschreibung	Laufrad ø 103mm H 25mm Laufrichtung rechts Gewinde M8L Aufnahme ø 12,2mm Schaufeln 6		

			
1			
GEV-Nr.	521273	Vergl.-Nr.	N/A
Beschreibung	Laufrad ø 103mm H 27mm Laufrichtung links Gewinde M7R Welle ø 12mm Wellenlänge 10mm Schaufeln 6		

			
1			
GEV-Nr.	501313	Vergl.-Nr.	N/A
Beschreibung	Laufrad ø 103mm H 28mm Achsaufnahme ø 9/8mm		

			
1			
GEV-Nr.	518067	Vergl.-Nr.	N/A
Beschreibung	Laufrad ø 103mm H 29mm M7L		

			
1			
GEV-Nr.	510529	Vergl.-Nr.	N/A
Beschreibung	Laufrad ø 103mm H 30mm Achsaufnahme ø 9/8mm Laufrichtung rechts Schaufeln 6		

			
1			
GEV-Nr.	509010	Vergl.-Nr.	N/A
Beschreibung	Laufrad ø 105mm H 20mm M10L Laufrichtung rechts Schaufeln 4		

			
1			
GEV-Nr.	521219	Vergl.-Nr.	N/A
Beschreibung	Laufrad ø 106mm H 27mm Gewinde M8R Welle ø 28mm Wellenlänge 10mm Aufnahme ø 12mm Schaufeln 6		

			
1			
GEV-Nr.	510834	Vergl.-Nr.	N/A
Beschreibung	Laufrad ø 110mm H 29mm Gewinde M8R passend für FIR		

			
1			
GEV-Nr.	521014	Vergl.-Nr.	N/A
Beschreibung	Laufrad ø 110mm H 32mm Laufrichtung rechts Gewinde M8L Welle ø 28mm Wellenlänge 3mm Aufnahme ø 12,2mm Schaufeln 6		

			
1			
GEV-Nr.	510602	Vergl.-Nr.	1225315/S
Beschreibung	Laufrad ø 110mm H 34mm Laufrichtung rechts Gewinde M8L Welle ø 28mm Aufnahme ø 12,2mm Schaufeln 6		

			
1			
GEV-Nr.	510612	Vergl.-Nr.	N/A
Beschreibung	Laufrad ø 110mm H 34mm M8R		

			
1			
GEV-Nr.	502277	Vergl.-Nr.	N/A
Beschreibung	Laufrad ø 111mm H 31mm Gewinde M8L		

			
1			
GEV-Nr.	698772	Vergl.-Nr.	N/A
Beschreibung	Laufrad ø 113mm H 34mm M10L Pumpentyp 1227.2711M10 Laufrichtung rechts passend für FIR Schaufeln 6		

			
1			
GEV-Nr.	510599	Vergl.-Nr.	N/A
Beschreibung	Laufrad ø 123mm H 34mm M8L		

			
1			
GEV-Nr.	521213	Vergl.-Nr.	N/A
Beschreibung	Laufrad ø 117mm H 24mm M8L		

			
1			
GEV-Nr.	510357	Vergl.-Nr.	N/A
Beschreibung	Laufrad ø 124mm H 34/16mm Gewinde M8R Schaufeln 6		

			
1			
GEV-Nr.	521215	Vergl.-Nr.	N/A
Beschreibung	Laufrad ø 118mm H 34mm Laufrichtung rechts Gewinde M8L Aufnahme ø 12mm Schaufeln 6		

			
1			
GEV-Nr.	521277	Vergl.-Nr.	N/A
Beschreibung	Laufrad ø 135mm H 39mm Pumpentyp Fir 2275; 3,7PS Gewinde M14x2L		

			
1			
GEV-Nr.	510604	Vergl.-Nr.	N/A
Beschreibung	Laufrad ø 118mm H 34mm M8R Laufrichtung links		

			
1			
GEV-Nr.	521200	Vergl.-Nr.	N/A
Beschreibung	Laufrad ø 63mm H 13mm Welle ø 11mm Wellenlänge 32mm		

			
1			
GEV-Nr.	502122	Vergl.-Nr.	N/A
Beschreibung	Laufrad ø 119mm H 33mm M8R		

			
1			
GEV-Nr.	521279	Vergl.-Nr.	N/A
Beschreibung	Laufrad ø 64mm H 17mm Gewinde M5L Schaufeln 3 Metall		

			
1			
GEV-Nr.	521017	Vergl.-Nr.	N/A
Beschreibung	Laufrad ø 120mm H 35mm Laufrichtung rechts Gewinde M14x2L Aufnahme ø 18mm Schaufeln 6		



1

GEV-Nr.	521266	Vergl.-Nr.	N/A
Beschreibung	Lauftrad ø 67mm H 18mm Gewinde M7 Welle ø 11mm Wellenlänge 32mm Schaufeln 3		



1

GEV-Nr.	521202	Vergl.-Nr.	N/A
Beschreibung	Lauftrad ø 72mm H 17mm Gewinde M5L		



1

GEV-Nr.	521201	Vergl.-Nr.	N/A
Beschreibung	Lauftrad ø 72mm H 18mm Gewinde M7 Welle ø 11mm Wellenlänge 32mm Schaufeln 3		



1

GEV-Nr.	521203	Vergl.-Nr.	N/A
Beschreibung	Lauftrad ø 72mm H 18mm Gewinde M7 Welle ø 11mm Wellenlänge 32mm Schaufeln 3		



1

GEV-Nr.	510532	Vergl.-Nr.	X2228-HP,0,20_(1)
Beschreibung	Lauftrad ø 72mm H 22mm Pumpentyp B229 Gewinde M7 Welle ø 11mm Wellenlänge 32mm Schaufeln 3		



1

GEV-Nr.	501314	Vergl.-Nr.	N/A
Beschreibung	Lauftrad ø 75mm		



1

GEV-Nr.	521566	Vergl.-Nr.	N/A
Beschreibung	Lauftrad ø 80mm H 15mm M7L Pumpentyp B226H		



1

GEV-Nr.	521207	Vergl.-Nr.	N/A
Beschreibung	Lauftrad ø 80mm H 18mm Achsaufnahme ø 9x8mm Laufrichtung rechts passend für HOONVED Schaufeln 5		



1

GEV-Nr.	501309	Vergl.-Nr.	N/A
Beschreibung	Lauftrad ø 80mm H 19mm M7R Pumpentyp Typ D1		



1

GEV-Nr.	510605	Vergl.-Nr.	N/A
Beschreibung	Lauftrad ø 80mm H 21mm M7L		



1

GEV-Nr.	510609	Vergl.-Nr.	N/A
Beschreibung	Lauftrad ø 84mm H 21mm M7L		



1

GEV-Nr.	510607	Vergl.-Nr.	N/A
Beschreibung	Laufrad ø 85mm H 29mm Achsaufnahme ø 9x8mm Laufrichtung rechts Schaufeln 6		



1

GEV-Nr.	510608	Vergl.-Nr.	N/A
Beschreibung	Laufrad ø 93mm H 32mm Achsaufnahme ø 9/8mm Schaufeln 6 Innenhöhe 11mm		



1

GEV-Nr.	502015	Vergl.-Nr.	N/A
Beschreibung	Laufrad ø 86mm H 22mm Achsaufnahme ø 9/8mm		



1

GEV-Nr.	510610	Vergl.-Nr.	N/A
Beschreibung	Laufrad ø 95,5mm H 23mm Achsaufnahme ø 9/8mm Laufrichtung rechts Aufnahme ø 16mm Schaufeln 6		



1

GEV-Nr.	502276	Vergl.-Nr.	N/A
Beschreibung	Laufrad ø 90mm H 30mm Gewinde M8L		



1

GEV-Nr.	524358	Vergl.-Nr.	N/A
Beschreibung	Laufrad ø 96mm H 23mm Achsaufnahme ø M7Lmm Laufrichtung rechts passend für MEIKO Welle ø 12mm Wellenlänge 9mm Schaufeln 6		



1

GEV-Nr.	521001	Vergl.-Nr.	N/A
Beschreibung	Laufrad ø 91mm H 30mm Pumpentyp B267.4050 Laufrichtung rechts		



1

GEV-Nr.	521210	Vergl.-Nr.	N/A
Beschreibung	Laufrad ø 96mm H 30mm Achsaufnahme ø 9/8mm Aufnahme ø 16mm Schaufeln 6		



1

GEV-Nr.	521177	Vergl.-Nr.	N/A
Beschreibung	Laufrad ø 93mm H 23mm Gewinde M10L passend für FIR		



1

GEV-Nr.	521082	Vergl.-Nr.	N/A
Beschreibung	Laufrad ø 96mm H 32mm Laufrichtung rechts Gewinde M8L		



1

GEV-Nr.	521061	Vergl.-Nr.	N/A
Beschreibung	Laufrad ø 93mm H 27mm Achsaufnahme ø 9x8mm Laufrichtung links Schaufeln 6		



			
GEV-Nr.	521067	Vergl.-Nr.	N/A
Beschreibung	Servicekit für Pumpe Typ 2233S1500 Laufrad, Pumpendeckeldichtung, Gleitringdichtung		
Ersatzteile zu	521067		
	GEV-Nr.	510552	Vergl.-Nr. N/A
Pumpendeckeldichtung			
	GEV-Nr.	510693	Vergl.-Nr. N/A
Gleitringdichtung für Wellen ø 12mm			

Pumpendeckeldichtungen

			
GEV-Nr.	521730	Vergl.-Nr.	N/A
Beschreibung	Flanschdichtung EPDM Materialstärke 5mm ID ø 155mm VPE 1 Stück		

			
GEV-Nr.	509002	Vergl.-Nr.	N/A
Beschreibung	O-Ring EPDM Materialstärke 2,62mm ID ø 82,22mm VPE 1 Stück		

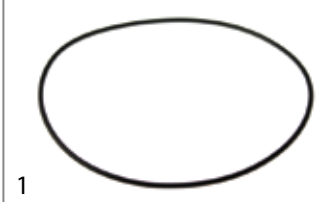
			
GEV-Nr.	521718	Vergl.-Nr.	N/A
Beschreibung	O-Ring EPDM Materialstärke 3,53mm ID ø 164,7mm VPE 1 Stück		

			
GEV-Nr.	532718	Vergl.-Nr.	N/A
Beschreibung	O-Ring EPDM Materialstärke 4mm ID ø 80mm VPE 1 Stück		

			
GEV-Nr.	502007	Vergl.-Nr.	N/A
Beschreibung	Pumpendeckeldichtung		

			
GEV-Nr.	521700	Vergl.-Nr.	N/A
Beschreibung	Pumpendeckeldichtung		

			
GEV-Nr.	521701	Vergl.-Nr.	N/A
Beschreibung	Pumpendeckeldichtung		

			
GEV-Nr.	521707	Vergl.-Nr.	N/A
Beschreibung	Pumpendeckeldichtung		

			
GEV-Nr.	521703	Vergl.-Nr.	N/A
Beschreibung	Pumpendeckeldichtung EPDM Materialstärke 2,5mm ID ø 75mm VPE 1 Stück		

			
GEV-Nr.	510551	Vergl.-Nr.	N/A
Beschreibung	Pumpendeckeldichtung ID ø 158,3mm Pumpentyp 1214/1293/1225/2243/1226/1204/3473/1241 Materialstärke 3,53mm EPDM VPE 1 Stück		

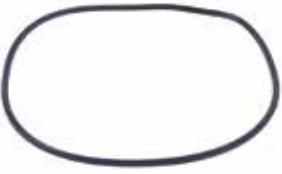

1

GEV-Nr.	521026	Vergl.-Nr.	N/A
Beschreibung	Pumpendeckeldichtung ID ø 182,5mm Materialstärke 5x4,5mm		



1

GEV-Nr.	521702	Vergl.-Nr.	N/A
Beschreibung	Pumpendeckeldichtung Materialstärke 3,5x4,5mm VPE 1 Stück		



1

GEV-Nr.	524416	Vergl.-Nr.	N/A
Beschreibung	Pumpendeckeldichtung Materialstärke 4x4mm VPE 1 Stück		



1

GEV-Nr.	510552	Vergl.-Nr.	N/A
Beschreibung	Pumpendeckeldichtung Pumpentyp 1292-2/3942/3981/3911/3983		



1

GEV-Nr.	521565	Vergl.-Nr.	N/A
Beschreibung	Pumpendeckeldichtung Pumpentyp B226H		

Pumpendeckel



1

GEV-Nr.	521500	Vergl.-Nr.	N/A
Beschreibung	Pumpendeckel		



1

GEV-Nr.	510384	Vergl.-Nr.	N/A
Beschreibung	Pumpendeckel Eingang ø 28mm Ausgang ø 26mm ø 100mm ID ø 76mm		



1

GEV-Nr.	502265	Vergl.-Nr.	5213EB2450
Beschreibung	Pumpendeckel Eingang ø 30mm Ausgang ø 26mm ID ø 89mm Innenhöhe 35mm		



1

GEV-Nr.	521501	Vergl.-Nr.	N/A
Beschreibung	Pumpendeckel Eingang ø 30mm Ausgang ø 30mm Pumpentyp 4134		



1

GEV-Nr.	521511	Vergl.-Nr.	N/A
Beschreibung	Pumpendeckel Eingang ø 60mm Ausgang ø 50/30mm Hilfsdruck M12x1,75 Hilfsdruck offen Pumpentyp 2233 Drehrichtung rechts ø 160mm ID ø 120mm Innenhöhe 23mm		
Zubehör zu	521511		
	GEV-Nr.	517319	Vergl.-Nr. —
	Schlauchanschluss G1: M12x1,75 Schlauch ø 11mm		



1

GEV-Nr.	698773	Vergl.-Nr.	N/A
Beschreibung	Pumpendeckel Eingang ø 63mm Ausgang ø 47mm Drehrichtung rechts ø 194mm ID ø 158mm		



1

GEV-Nr.	521544	Vergl.-Nr.	N/A
Beschreibung	Pumpendeckel Eingang ø 63mm Ausgang ø 50mm Drehrichtung rechts ø 180mm ID ø 165mm Innenhöhe 42mm		



1

GEV-Nr.	521515	Vergl.-Nr.	N/A
Beschreibung	Pumpendeckel Eingang ø 70mm Ausgang ø 60mm		



1

GEV-Nr.	521571	Vergl.-Nr.	2240303
Beschreibung	Pumpendeckel FIR Eingang ø 30mm Ausgang ø 30mm Drehrichtung rechts ø 128mm ID ø 100mm Innenhöhe 21mm		



1

GEV-Nr.	521505	Vergl.-Nr.	X4247-HP.0,6_(1)
Beschreibung	Pumpendeckel FIR Eingang ø 37mm Ausgang ø 40mm Drehrichtung rechts ø 160mm ID ø 125mm Innenhöhe 25mm		



1

GEV-Nr.	502014	Vergl.-Nr.	N/A
Beschreibung	Pumpendeckel FIR Eingang ø 45mm Ausgang ø 40mm		



1

GEV-Nr.	511187	Vergl.-Nr.	N/A
Beschreibung	Pumpendeckel FIR Eingang ø 45mm Ausgang ø 40mm Drehrichtung rechts ø 160mm ID ø 122mm Innenhöhe 21mm		



1

GEV-Nr.	521506	Vergl.-Nr.	N/A
Beschreibung	Pumpendeckel FIR Eingang ø 45mm Ausgang ø 40mm Drehrichtung rechts ø 160mm ID ø 125mm Innenhöhe 25mm		



1

GEV-Nr.	521539	Vergl.-Nr.	N/A
Beschreibung	Pumpendeckel FIR Eingang ø 45mm Ausgang ø 40mm Hilfsdruck 10mm Hilfsdruck offen Drehrichtung rechts ø 160mm ID ø 125mm Innenhöhe 25mm		



1

GEV-Nr.	510508	Vergl.-Nr.	N/A
Beschreibung	Pumpendeckel FIR Eingang ø 45mm Ausgang ø 40mm Pumpentyp PU 0,5/3911 Drehrichtung rechts ø 160mm ID ø 125mm Innenhöhe 25mm		



1

GEV-Nr.	521567	Vergl.-Nr.	N/A
Beschreibung	Pumpendeckel FIR Eingang ø 50mm Ausgang ø 37mm ø 150mm ID ø 118mm Innenhöhe 25mm		



1

GEV-Nr.	521513	Vergl.-Nr.	N/A
Beschreibung	Pumpendeckel FIR Eingang ø 63mm Ausgang ø 47mm Drehrichtung rechts ID ø 150mm Innenhöhe 32mm		
Ersatzteile zu	521513		
	GEV-Nr.	504329	Vergl.-Nr. —
	Blindstopfen H 17,5mm Gewinde M16x1,5 Kunststoff		



1

GEV-Nr.	521512	Vergl.-Nr.	N/A
Beschreibung	Pumpendeckel FIR Eingang ø 60mm Ausgang ø 50mm		



1

GEV-Nr.	502274	Vergl.-Nr.	N/A
Beschreibung	Pumpendeckel FIR Eingang ø 63mm Ausgang ø 53mm		



1

GEV-Nr.	698762	Vergl.-Nr.	N/A
Beschreibung	Pumpendeckel FIR Eingang ø 60mmmm Ausgang ø 50mmmm Pumpentyp 4298.1404 Drehrichtung rechts ø 156,5mm		



1

GEV-Nr.	502013	Vergl.-Nr.	N/A
Beschreibung	Pumpendeckel FIR Eingang ø 63mm Ausgang ø 53mm Hilfsdruck 1/2" Drehrichtung links ø 185mm ID ø 150mm Innenhöhe 37mm		



1

GEV-Nr.	521028	Vergl.-Nr.	N/A
Beschreibung	Pumpendeckel FIR Eingang ø 62mm Ausgang ø 62mm Drehrichtung rechts ø 215mm ID ø 175mm Innenhöhe 40mm		



1

GEV-Nr.	510531	Vergl.-Nr.	N/A
Beschreibung	Pumpendeckel FIR Eingang ø 63mm Ausgang ø 53mm Hilfsdruck M16x1,5mm Hilfsdruck offen Drehrichtung links ø 185mm ID ø 150mm Innenhöhe 37mm		
Ersatzteile zu	510531		
	GEV-Nr.	504329	Vergl.-Nr. —
	Blindstopfen H 17,5mm Gewinde M16x1,5 Kunststoff		



1

GEV-Nr.	502273	Vergl.-Nr.	N/A
Beschreibung	Pumpendeckel FIR Eingang ø 63mm Ausgang ø 2x40mm Pumpentyp 4267.5050 Drehrichtung rechts		



1			
GEV-Nr.	521545	Vergl.-Nr.	N/A
Beschreibung	Pumpendeckel FIR Typ B226H Eingang ø 33mm Ausgang ø 30/28mm		



1			
GEV-Nr.	510510	Vergl.-Nr.	X2212-HP.0,10_(1)
Beschreibung	Pumpendeckel Pumpentyp 2212/2228/2229/2211		



1			
GEV-Nr.	502012	Vergl.-Nr.	N/A
Beschreibung	Pumpendeckelunterteil für Waschpumpe		