

4

Elektrische Teile Electrical parts



Magnetventile
Magnetic valves

Seite 276



Schütze/Relais/
Pressostate/Thermostate
Contactors/relays/
Pressure switches/thermostats

Seite 279



Niveauregler/Elektronik
Level regulators/Electronic

Seite 282



Motoren/Pumpen
Engines/pumps

Seite 288



Schalter/Lampen
Switches/lamps

Seite 290



Hilfsmaterial
Accessories

Seite 295



Heizkörper
Heaters

Seite 298

Magnetventile/Scem Parker Magnetic valves/Scem Parker

3 Wege/3 ways



Abb. Pict.	Bestell-Nr. Order-No.	Beschreibung Description
1	370057	230VAC
1	370050	24VAC
1	370058	24VDC
2	370060	230VAC mit Kabel/with cable
3	370062	Ventilkörper/solenoid body

Magnetspulen/Magnetic coils



Abb. Pict.	Bestell-Nr. Order-No.	Beschreibung Description
1	371029	230VAC
1	371036	24VAC
1	371030	24VDC
2	371033	230VAC mit Kabel/with cable

Magnetventile/Lucifer Magnetic valves/Lucifer

3 Wege/3 ways

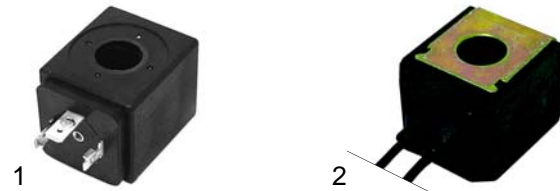

Abb. Pict.	Bestell-Nr. Order-No.	Beschreibung Description
1	370055	230VAC
1	370056	24VAC
2	370063	Ventilkörper/solenoid body
3	370212	1/8", 230VAC
3	370059	1/4", 230VAC
3	370219	1/4", 24VAC



Abb. Pict.	Bestell-Nr. Order-No.	Beschreibung Description
1	370053	230VAC
1	370054	24VAC
1	370051	24VDC
2	370061	Ventilkörper/solenoid body
3	370039	230VAC mit Handbetätigung/with manual actuation
4	370222	1/8", 230VAC
4	370223	1/4", 230VAC

2 Wege/2 ways



Abb. Pict.	Bestell-Nr. Order-No.	Beschreibung Description
1	370206	1/8", 230VAC
1	370066	1/8", 24VAC
1	370218	1/8", 24VDC
1	370067	1/4", 230VAC
1	370034	1/4", 24VAC
1	370221	1/4", 24VDC
2	370202	230VAC

2 Wege/2 ways



Abb. Pict.	Bestell-Nr. Order-No.	Beschreibung Description
1	370071	1/8", 230VAC
1	370230	1/8", 24VDC
2	370072	1/8", 230VAC
2	370224	1/8", 24VAC
2	370225	1/8", 24VDC
2	370088	1/4", 230VAC
2	370226	1/4", 24VAC
3	370211	230VAC

Magnetspulen/Magnetic coils

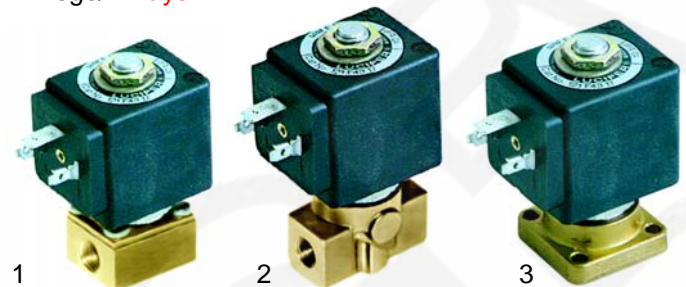

Pos. Item	Bestell-Nr. Order-No.	Beschreibung Description
1	371031	230VAC
2	371032	24VAC
3	371043	24VDC
4	371135	12VDC

2 Wege/2 ways



Abb. Pict.	Bestell-Nr. Order-No.	Größe Dimensions	Spule Coil	Typ Type	Körper Body
1	370169	1/8"	230VAC	Z610A	L179/1,6
1	370168	1/8"	230VAC	Z610A	L179/2,3
2	370083	1/4"	230VAC	Z610A	L171/3,0
2	370086	1/4"	24VAC	Z610A	L171/3,0

Magnetventile/Sirai Magnetic valves/Sirai

3 Wege/3 ways



Abb. Pict.	Bestell-Nr. Order-No.	Größe Dimensions	Spule Coil	Typ Type	Körper Body
1	370080	-	230VAC	ZA30A	L334
1	370081	-	24VAC	ZA30A	L334
1	370227	-	24VDC	ZA30E	L334
2	370210	1/8"	230VAC	Z610A	L377

Abb. Pict.	Bestell-Nr. Order-No.	Spule Coil	Typ Type
1	371047	230VAC	ZA30A
1	371048	24VAC	ZA30A
1	371049	24VDC	ZA30E
1	371067	230VAC	Z534A
1	371068	24VAC	Z534A
2	371071	230VAC	Z610A
2	371070	24VAC	Z610A
2	371069	24VDC	Z610A

2 Wege/2 ways

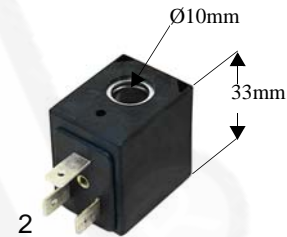

Abb. Pict.	Bestell-Nr. Order-No.	Größe Dimensions	Spule Coil	Typ Type	Körper Body
1	370082	1/8"	230VAC	ZA30A	L120/2,3
1	370064	1/8"	24VAC	ZA30A	L120/2,3
2	370228	1/4"	230VAC	ZA30A	L121/2,3
2	370229	1/4"	24VAC	ZA30A	L121/2,3
3	370084	1/4"	230VAC	Z534A	L129/3,2
3	370087	1/4"	24VAC	Z534A	L129/3,2

ACL



Abb. Pict.	Bestell-Nr. Order-No.	Beschreibung Description	Spule Coil
1	370217	3	230VAC
1	370166	3	24VDC
2	370215	1/8"	230VAC

Magnetventile/ODE Magnetic valves/ODE

3 Wege/3 ways



Abb. Pict.	Bestell-Nr. Order-No.	Beschreibung Description
1	370203	230VAC
1	370204	24VAC
1	370125	24VDC
2	370231	230VAC
2	370089	230V

2 Wege/2 ways



Abb. Pict.	Bestell-Nr. Order-No.	Beschreibung Description
1	370208	1/8", 230VAC
1	370209	1/8", 24VAC
1	370145	1/4", 230VAC
1	370139	1/4", 24VAC
2	370093	230VAC

Magnetspulen/Magnetic coils

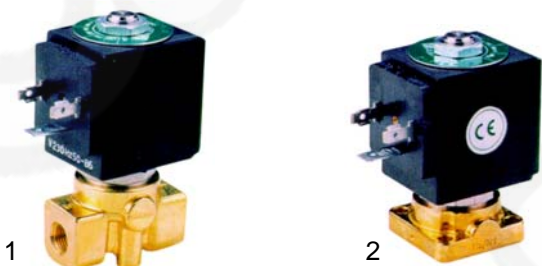

Pos. Item	Bestell-Nr. Order-No.	Beschreibung Description
1	371150	230VAC
2	371151	24VAC
3	371152	24VDC

Magnetventile/M&M Magnetic valves/M&M

3 Wege/3 ways



Abb. Pict.	Bestell-Nr. Order-No.	Größe Dimension	Spule Coil	Typ Type
1	370207	-	230VAC	7
2	370213	-	230VAC	7
3	370214	1/8"	230VAC	2

2 Wege/2 ways

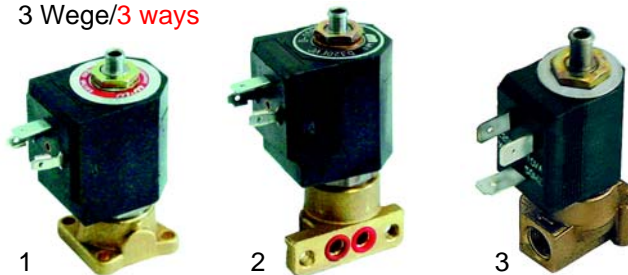

Abb. Pict.	Bestell-Nr. Order-No.	Größe Dimension	Spule Coil	Typ Type
1	370095	-	230VAC	2
2	370165	1/8"	230VAC	2
2	370167	1/8"	24VDC	2

Magnetspulen/Magnetic coils



Abb. Pict.	Bestell-Nr. Order-No.	Beschreibung Description
1	371026	230VAC
1	371027	24VAC
2	371022	230VAC
2	371023	24VAC

Magnetventile-Zubehör/Solenoid valves-accessories



Abb. Pict.	Bestell-Nr. Order-No.	Beschreibung Description
1	371090	Stecker DIN 43650D/Plug DIN 43650D
2	371091	Stecker DIN 43650B/Plug DIN 43650B
3	371095	O-Ring (Viton) /O-ring (viton)
4	371100	O-Ring (Silikon) /O-ring (silicon)

Schütze Contactors



Abb. Pict.	Bestell-Nr. Order-No.	Spule Coil	Kontakte Contacts	AC1 AC1
1	380402	12VDC	3S + 1Ö/3NO + 1NC	20A
1	380401	12VDC	3S + 1S/3NO + 1NO	20A
1	380417	24VDC	3S + 1Ö/3NO + 1NC	20A
1	380418	24VDC	3S + 1S/3NO + 1NO	20A
1	380411	24VAC	3S + 1Ö/3NO + 1NC	20A
1	380412	24VAC	3S + 1S/3NO + 1NO	20A
1	380212	230VAC	3S + 1Ö/3NO + 1NC	20A
1	380213	230VAC	3S + 1S/3NO + 1NO	20A
1	380413	400VAC	3S + 1Ö/3NO + 1NC	20A
1	380414	400VAC	3S + 1S/3NO + 1NO	20A
2	380419	24VAC	3S + 1Ö/3NO + 1NC	25A
2	380420	24VAC	3S + 1S/3NO + 1NO	25A
2	380203	230VAC	3S + 1Ö/3NO + 1NC	25A
2	380204	230VAC	3S + 1S/3NO + 1NO	25A
2	380421	400VAC	3S + 1Ö/3NO + 1NC	25A
2	380422	400VAC	3S + 1S/3NO + 1NO	25A

Relais Relays

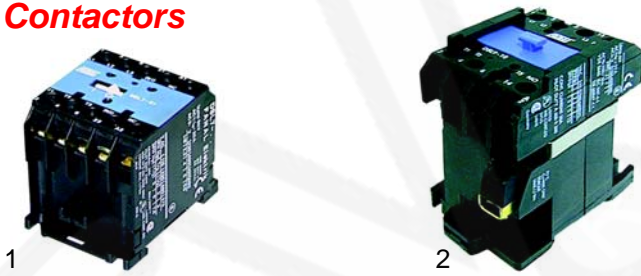

Abb. Pict.	Bestell-Nr. Order-No.	Spule Coil	Kontakte Contacts	AC1 AC1
1	380134	230VAC	2 Wechsler/2 changer	10A
2	380132	230VAC	3 Wechsler/3 changer	10A

Abb. Pict.	B.-Nr. O.-No.	Beschreibung Description
3	380137	Socket, 8-polig/Base, 8 poles
3	380136	Socket, 11-polig/Base, 11 poles

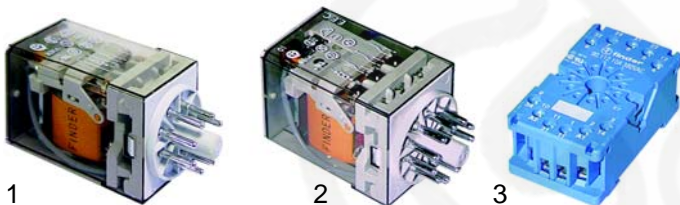

Abb. Pict.	Bestell-Nr. Order-No.	Spule Coil	Kontakte Contacts	AC1 AC1
1	380315	230VAC	2 Schließer/2 closer (NO)	16A
2	380130	230VAC	3 Schließer/3 closer (NO)	16A
3	380131	230VAC	2 Wechsler/2 changer	16A

Relais Relays

Faston 6,3mm

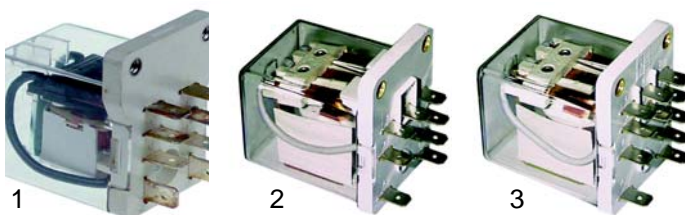

Abb. Pict.	Bestell-Nr. Order-No.	Spule Coil	Kontakte Contacts	AC1 AC1
1	380139	230VAC	2 Wechsler/2 changer	16A
1	380138	24VAC	2 Wechsler/2 changer	16A
2	380311	230VAC	1S + 1Ö/1NO + 1 NC	20A
3	380185	230VAC	1 Schließer/1 closer	30A

Faston 4,8mm

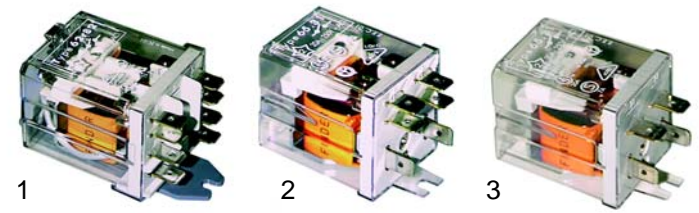

Pos. Item	Bestell-Nr. Order-No.	Spule Coil	Kontakte Contacts	AC1 AC1
1	380312	230VAC	3 Wechsler/3 changer	10A

Steckrelais/Terminal relays



Abb. Pict.	Bestell-Nr. Order-No.	Spule Coil	Kontakte Contacts	AC1 AC1
1	380475	230VAC	2 Wechsler/2 changer	10A

Abb. Pict.	B.-Nr. O.-No.	Beschreibung Description
2	380476	Socket/Base

Lötrelais/Soldering relays



Abb. Pict.	Bestell-Nr. Order-No.	Spule Coil	Kontakte Contacts	AC1 AC1
1	380348	12VDC	1 Wechsler/1 changer	16A
2	380349	24VDC	1 Wechsler/1 changer	10A

Pressostate

Pressure switches

3 Wege/3 ways

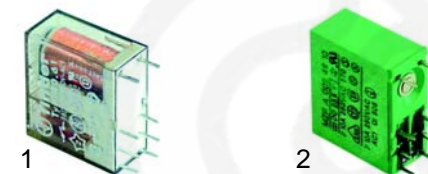

Abb. Pict.	Bestell-Nr. Order-No.	Beschreibung Description
1	541021	1/4", 3-polig, 0,5 bis 1,2bar 1/4", 3 poles, 0,5 to 1,2bar
2	520139	Membranensatz/Membrane set



Zweiter Mikroschalter
nicht sichtbar!
Second micro switch not
visible!

Abb. Pict.	B.-Nr. O.-No.	Beschreibung Description
1	541089	1/8", 1-polig, 0,5 bis 1,2bar 1/8", 1 pole, 0,5 to 1,2bar
1	541340	1/8", 1-polig, 0,9bar/eingestellt 1/8", 1 pole, 0,9bar/focussed
1	541155	1/8", 1-polig, 1 bis 2bar 1/8", 1 pole, 1 to 2bar
1	541341	1/8", 1-polig, 2bar/eingestellt 1/8", 1 pole, 2bar/focussed
1	541154	1/8", 1-polig, 2,3bar/eingestellt 1/8", 1 pole, 2,3bar/focussed
2	541020	1/4", 1-polig, 0,5 bis 1,2bar 1/4", 1 pole, 0,5 to 1,2bar
2	541158	1/4", 1-polig, 1 bis 2,5bar 1/4", 1 pole, 1 to 2,5bar
2	541153	1/4", 1-polig, 1,2bar/eingestellt 1/4", 1 pole, 1,2bar/focussed
2	541151	1/4", 1-polig, 1,1bar/eingestellt 1/4", 1 pole, 1,1bar/focussed
2	541152	1/4", 1-polig, 1,0bar/eingestellt 1/4", 1 pole, 1,0bar/focussed
3	541107	1/4", 2-polig, Spezialversion passend für Carimali 1/4", 2 poles, 1,1bar/foc., Special version suit. f. Carimali

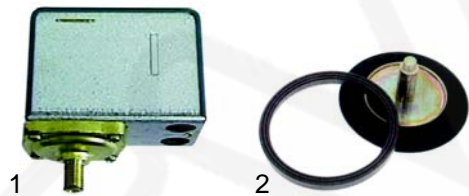

Abb. Pict.	B.-Nr. O.-No.	Beschreibung Description
1	541042	1/4", 1-polig, 1 bis 2,8bar 1/4", 1 pole, 1 to 2,8bar
2	541143	1/8", 1-polig, 0,2 bis 6bar 1/8", 1 pole, 0,2 to 6bar
3	541131	1/4", 1-polig, 0,2 bis 6bar 1/4", 1 pole, 0,2 to 6bar

Stabthermostate

Bar thermostates



Abb. Pict.	Bestell-Nr. Order-No.	Beschreibung Description
1	390433	2-polig, 145°C, 20A 2 poles, 145°C, 20A
2	390368	1-polig, 40 bis 150°C, 15A 1 pole, 40 to 150°C, 15A

Thermostate

Thermostats



Abb. Pict.	Bestell-Nr. Order-No.	Beschreibung Description
1	390114	1-polig, 30 bis 110°C, 16A 1 pole, 30 to 110°C, 16A
2	390109	1-polig, 75 bis 120°C, 16A 1 pole, 75 to 120°C, 16A

Sicherheitshermostate

Safety thermostats

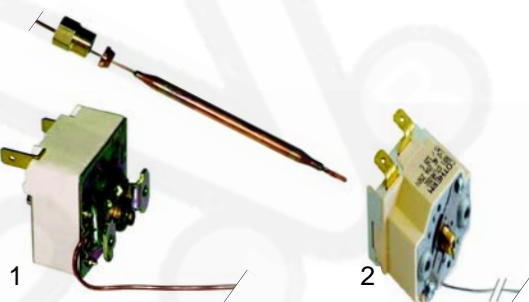

Abb. Pict.	Bestell-Nr. Order-No.	Beschreibung Description
1	390324	3-polig, 169°C, 20A 3 poles, 169°C, 20A
2	390166	3-polig, 160°C, 20A 3 poles, 160°C, 20A

Anlegethermostate M4 Stoke thermostats M4



Pos. Item	Bestell-Nr. Order-No.	Temp. Temp.	Pos. Item	Bestell-Nr. Order-No.	Temp. Temp.
1	390320	90°C	8	390326	130°C
2	390128	95°C	9	390153	135°C
3	390322	100°C	10	390323	145°C
4	390152	107°C	11	390327	150°C
5	375160	110°C	12	390328	152°C
6	390321	120°C	13	390329	165°C
7	390129	125°C			

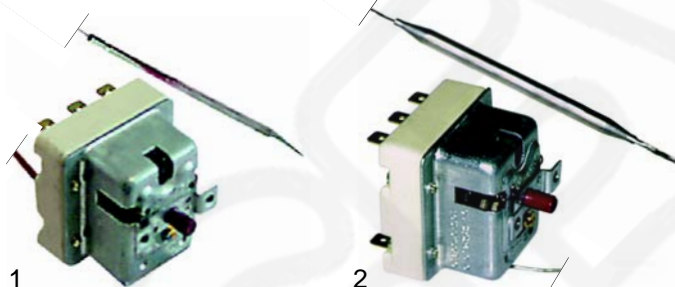

Pos. Item	Bestell-Nr. Order-No.	Temperatur Temperature
1	390414	140°C



Pos. Item	Bestell-Nr. Order-No.	Temp. Temp.	Pos. Item	Bestell-Nr. Order-No.	Temp. Temp.
1	390396	92°C	9	390354	135°C
2	390104	95°C	10	390355	140°C
3	390436	130°C	11	390356	145°C
4	390350	110°C	12	390357	150°C
5	390351	120°C	13	390358	155°C
6	390352	125°C	14	390359	160°C
7	390398	127°C	15	390360	165°C
8	390353	130°C	16	390435	180°C

Sicherheitsthermostate M4 Safety thermostats M4



Pos. Item	Bestell-Nr. Order-No.	Temp. Temp.	Pos. Item	Bestell-Nr. Order-No.	Temp. Temp.
1	390370	145°C	3	390372	165°C
2	390371	152°C			

Sicherheits-Anlege-Thermostate Safety stoke thermostats



Abb. Pict.	Bestell-Nr. Order-No.	Temp. Temp.	Abb. Pict.	Bestell-Nr. Order-No.	Temp. Temp.
1	390375	95°C	2	390379	150°C
1	390413	100°C	2	390380	155°C
1	390177	110°C	2	390381	160°C
			2	390443	165°C
1	390376	130°C	2	390374	170°C
1	390377	135°C	2	390369	175°C
1	390378	140°C			

Befestigungen/Fixings



Abb. Pict.	Bestell-Nr. Order-No.	Temp. Temp.	Abb. Pict.	Bestell-Nr. Order-No.	Temp. Temp.
1	550388	Halter Holder	2	550389	Halter Holder

Anlege-Thermostate Stoke thermostats



Abb. Pict.	B.-Nr. O.-No.	Beschreibung Description	Abb. Pict.	B.-Nr. O.-No.	Beschreibung Description
1	390431	2-polig, 40A 2 poles, 40A	3	390325	2-polig, 115°C, 16A 2 poles, 115°C, 16A
2	390434	2-polig, 20A 2 poles, 20A	3	390411	2-polig, 130°C, 16A 2 poles, 130°C, 16A

Sicherheits-Thermostate Safety thermostats

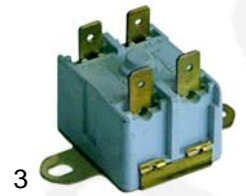
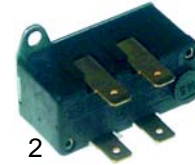

Abb. Pict.	Bestell-Nr. Order-No.	Beschreibung Description
1	390367	2-polig, 130°C, 16A/2 poles, 130°C, 16A

Niveauregler Level regulators

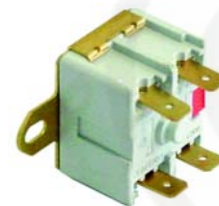

Abb. Pict.	Bestell-Nr. Order-No.	Gerätetyp Device type
1	400010	RL70/1E-2C/8, 9.1.08.06, 230VAC
2	400240	RL30/1E-2C/8, 9.1.00.67, 230VAC
2	400237	RL30/1E-2C/8, 9.1.00.10, 230VAC
2	400408	RL30/1E/8, 9.1.00.00, 230VAC
3	400400	RL40/Gr/8, 230VAC
3	400474	RL40/Gr/8, 24VAC

Niveauregler Level regulators



Abb. Pict.	Bestell-Nr. Order-No.	Gerätetyp Device type
1	400019	RL30/1E-2C/F, 9.1.40.23, 230VAC
1	400417	RL30/1E-2C/F, 9.1.40.20, 230VAC
2	400246	RL30/1E/F, 9.1.00.02, 230VAC
3	400245	RL30/2E/F, 9.1.01.03, 230VAC

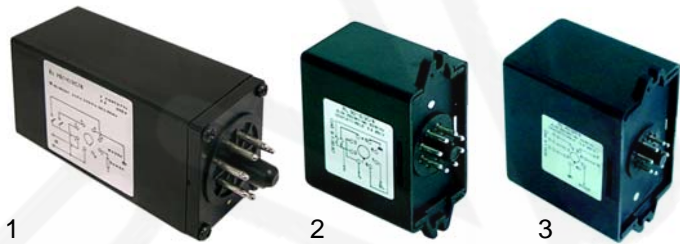

Abb. Pict.	Bestell-Nr. Order-No.	Gerätetyp Device type
1	400017	RL30/1E-2C/11, 9.1.40.02, 230VAC
2	400234	RL30/3ES/11, 9.1.19.63, 230VAC
3	400230	RL40/1E/11, 9.1.10.24, 230VAC
3	400231	RL40/1E/11, 9.1.10.16, 24VAC



Abb. Pict.	Bestell-Nr. Order-No.	Gerätetyp Device type
1	400244	RL30/2E-2R/F, 9.1.16.00, 230VAC
2	400241	RL30/2ES/F, 9.1.19.09, 230VAC
3	400238	RL30/3ES/F+Buzzer, 9.1.19.61, 230VAC

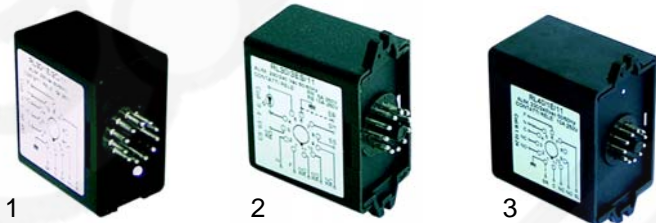

Pos. Pict.	Bestell-Nr. Order-No.	Gerätetyp Device type
1	400086	RL60/1DT/11, 9.1.09.01, 230VAC
2	400087	RL60/1DT/11, 9.1.09.00, 24VAC



Pos. Item	Bestell-Nr. Order-No.	Gerätetyp Device type
1	400239	RL40/3ES/F, 9.1.15.52, 230VAC

Socket Bases



Abb. Pict.	Bestell-Nr. Order-No.	Gerätetyp Device type
1	380137	Socket, 8-polig/Base, 8 poles
2	380136	Socket, 11-polig/Base, 11 poles

Niveausonde Level probes

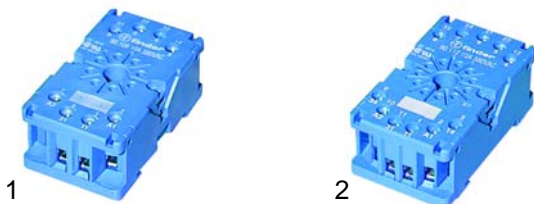

Pos. Item	Bestell-Nr. Order-No.	Beschreibung Description
1	400212	1/4", L=120
2	400213	1/4", L=125
3	400214	1/4", L=140
4	400020	1/4", L=150

Flowmeter Flowmeters Gicar



Abb. Pict.	Bestell-Nr. Order-No.	Beschreibung Description
1	400255	Flowmeter, 1/8", Steckeranschluss Flowmeter, 1/8", plug connection
1	400004	Flowmeter, 1/4", Steckeranschluss Flowmeter, 1/4", plug connection
2	400222	Flowmeter, 1/4", Fastonanschluss Flowmeter, 1/4", plug connection

Digma



Abb. Pict.	Bestell-Nr. Order-No.	Beschreibung Description
1	400209	Flowmeter, 1/4"
2	400005	Flowmeter, 1/4", mit Abzweig Flowmeter, 1/4", with branch



Pos. Item	Bestell-Nr. Order-No.	Beschreibung Description
1	400256	Stecker Plug
2	400257	Zählrad (Gicar) Flowmeter reel (Gicar)
2	400259	Zählrad (Digmesa) Flowmeter reel (Digmesa)
3	400258	Gehäusedichtung Case gasket

Universal Tastaturen Universal key push buttons

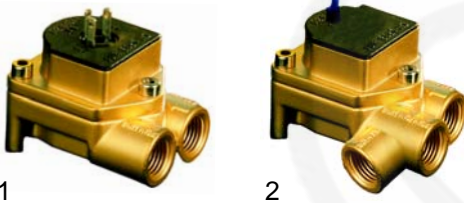

Abb. Pict.	Bestell-Nr. Order-No.	Tastaturentyp Key push button type
1	400389	Dos Mask no tea, 9.9.12.01
1	400362	Dos Mask+ tea, 9.9.12.00
2	400378	Dos Micro no tea, 9.9.10.17
2	400361	Tastatur, Dos Micro + tea, 9.9.10.24



Abb. Pict.	Bestell-Nr. Order-No.	Beschreibung Description
1	400226	Gicar 9.9.09.50
2	400227	Gicar 9.9.09.28

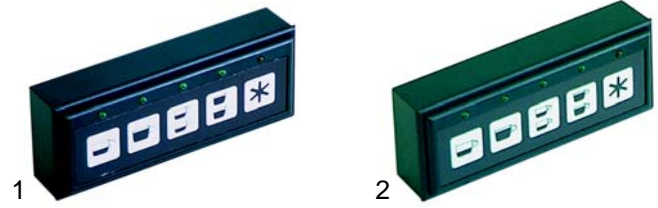
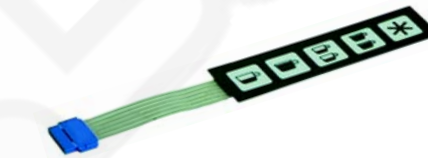

Pos. Item	Bestell-Nr. Order-No.	Beschreibung Description
1	400334	Folientastatur Push button panel

Universal Tastatur-Steuerungen Universal key push button controls



Pos. Item	Bestell-Nr. Order-No.	Beschreibung Description
1	400248	Dos- TH + RL, 9.5.26.02
1	400247	Dos- TH + Tea, 9.5.2604
2	400223	1d5 GRTL NKP S10 + Tea, 9.5.28.34.v.00
2	400508	1d5 GRTL NKP S10 + RL, 9.5.28.14.v.00

Zentraleinheiten

Electronic boxes

bis 2 Gruppen/up to 2 groups

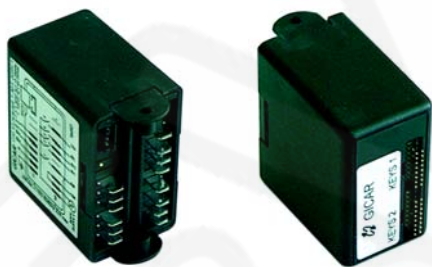

Pos. Item	Bestell-Nr. Order-No.	Beschreibung Description
1	400224	ET30/9.5.24.00.00 RL + Tea, 230VAC

bis 3 Gruppen/up to 3 groups



Pos. Item	Bestell-Nr. Order-No.	Beschreibung Description
1	400225	ET40/9.5.23.14.00 no Tea, 230VAC
2	400520	ET40/9.5.23.24.00 RL + Tea, 230VAC

Elektronikschalter

Electronic switches



Abb. Pict.	Bestell-Nr. Order-No.	Beschreibung Description	Einbaumaß Fitting dimensions
1	400641	Schlüsselschalter Key switch	12mm
2	345680	Hebelschalter, 3A/250V Lever switch, 3A/250V	6mm

Steckerbuchsen/Plug cases

Raster 2,54mm/Grid 2,54mm



Abb. Pict.	B.-Nr. O.-No.	Pole Poles	VPE Pack	Abb. Pict.	B.-Nr. O.-No.	Pole Poles	VPE Pack
1	400690	2	10	1	400693	6	5
1	400691	4	10	1	400694	8	5
				1	400695	10	5

Abb. Pict.	Bestell-Nr. Order-No.	Beschreibung Description	VPE Pack
2	400692	Crimp-Hülse/Crimp socket	50

Federleisten

Spring lathes



Pos. Item	Bestell-Nr. Order-No.	Pole Poles	Pos. Item	Bestell-Nr. Order-No.	Pole Poles
1	550800	2	13	550812	14
2	550801	3	14	550813	15
3	550802	4	15	550814	16
4	550803	5	16	550815	17
5	550804	6	17	550816	18
6	550805	7	18	550817	19
7	550806	8	19	550818	20
8	550807	9	20	550819	21
9	550808	10	21	550820	22
10	550809	11	22	550821	23
11	550810	12	23	550822	24
12	550811	13			

Schneidleisten

Cutting lathes



Pos. Item	Bestell-Nr. Order-No.	Pole Poles	Pos. Item	Bestell-Nr. Order-No.	Pole Poles
1	550830	10	3	550832	16
2	550831	14	4	550833	20

Flachbandkabel

Flat tape cable

Raster 1,27mm/VPE 5m

Grid 1,27mm/pack 5m

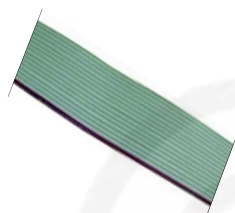

Pos. Item	Bestell-Nr. Order-No.	Pole Poles	Pos. Item	Bestell-Nr. Order-No.	Pole Poles
1	550834	10	3	550836	16
2	550835	14	4	550837	20

Schlüsselschalter

Key switches

konfektioniert/prepared



Abb. Pict.	Bestell-Nr. Order-No.	Beschreibung Description
1	400297	Für 1 Gruppe/For 1 group
2	400298	Für 2 Gruppen/For 2 groups
3	400299	For 3 Gruppen/For 3 groups

Tastaturkabel

Keyboard cable

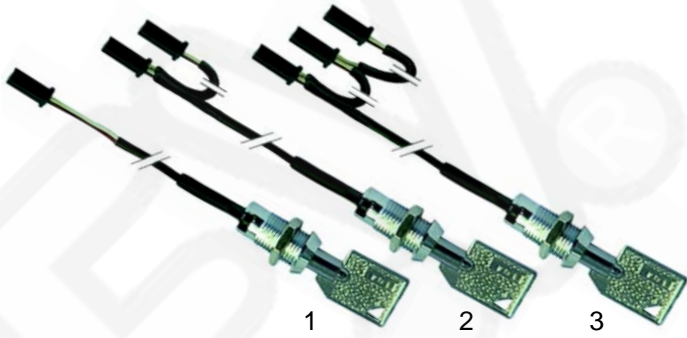
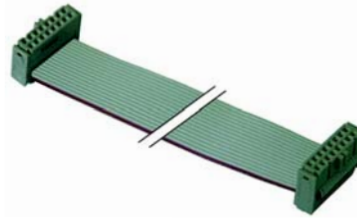

Pos. Item	B.-Nr. O.-No.	Länge Length	Pole Poles	Pos. Item	B.-Nr. O.-No.	Länge Length	Pole Poles
1	400228	60cm	2 x 8	3	400706	110cm	2 x 8
2	400229	80cm	2 x 8	4	400707	140cm	2 x 8

Schalter

Switches

konfektioniert/prepared

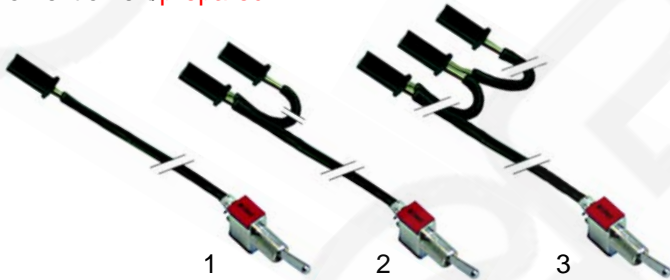

Pos. Item	Bestell-Nr. Order-No.	Beschreibung Description
1	346136	Für 1 Gruppe/For 1 group
2	346170	Für 2 Gruppen/For 2 groups
3	346171	For 3 Gruppen/For 3 groups

Tastaturkabel

Keyboard cable

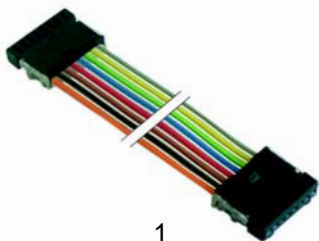

ohne Abbildung!
without picture

2

Abb. Pict.	B.-Nr. O.-No.	Länge Length	Pole Poles	Abb. Pict.	B.-Nr. O.-No.	Länge Length	Pole Poles
1	400700	60cm	8	2	400702	60cm	10
1	400701	80cm	8	2	400703	80cm	10
1	400485	110cm	8	2	400704	110cm	10
1	400332	140cm	8	2	400705	140cm	10

Legende: FM Flowmeter
 EVN Magnetventil (Niveau)
 EVT Magnetventil (Tee)
 EVG Magnetventil (Gruppe)
 M1 Drucksteigerungspumpe
 S1 Programmierschalter
 S2 Tee-Taster
 L1 Led

Abbreviations: FM Flowmeter
 EVN Solenoid valve (level)
 EVT Solenoid valve (tea)
 EVG Solenoid valve (group)
 M1 Pressure increasing pump
 S1 Programming switch
 S2 Tea-push button
 L1 Led

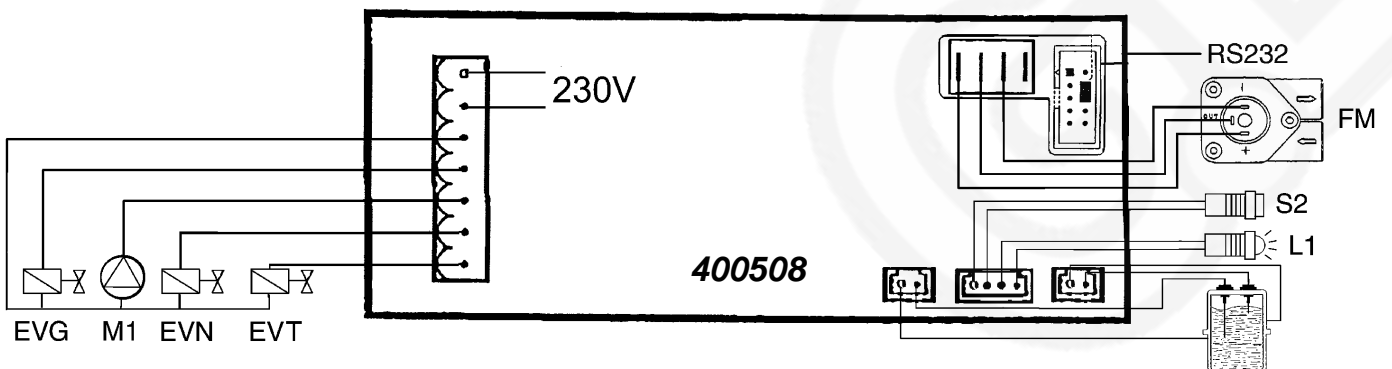
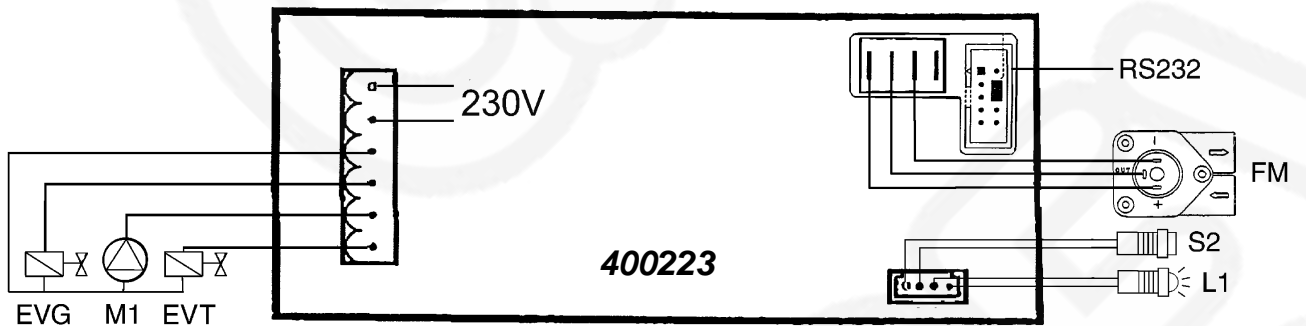
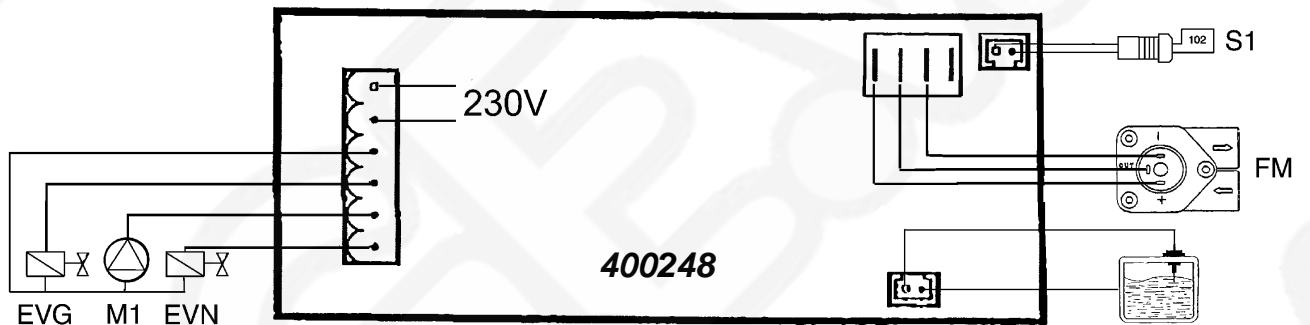
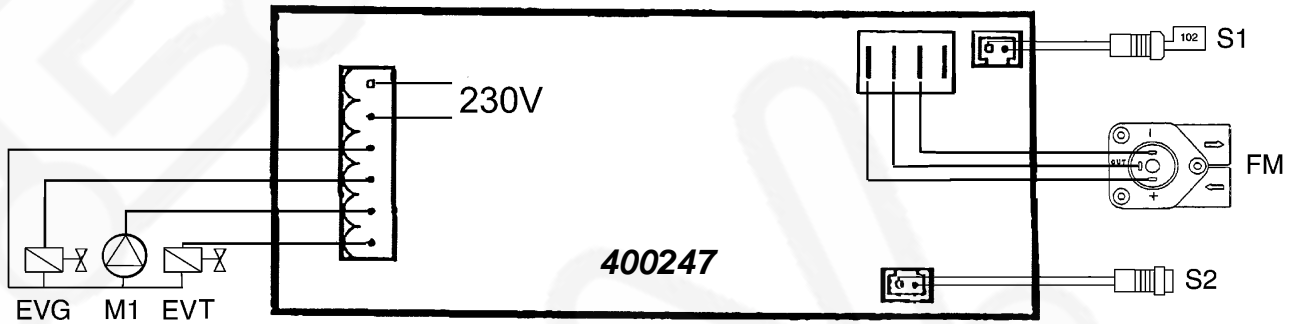

400224

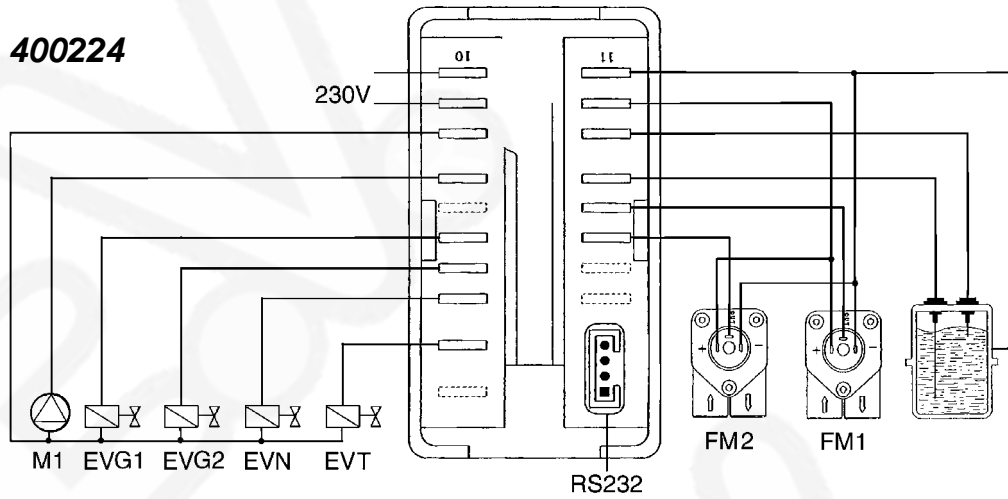

400225

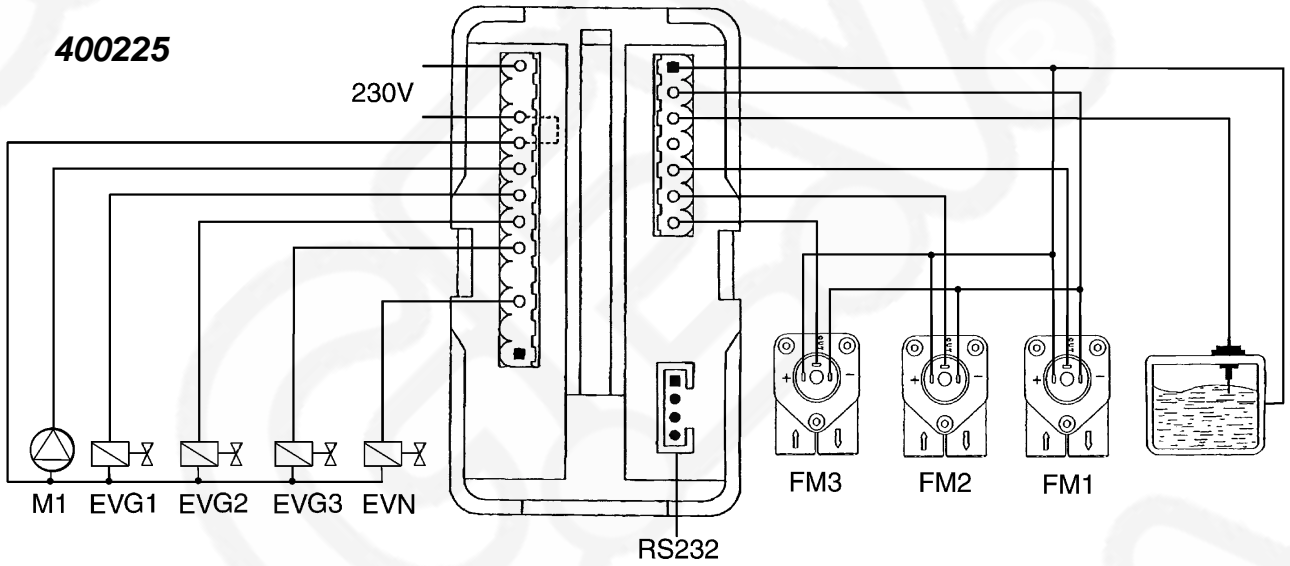

400520

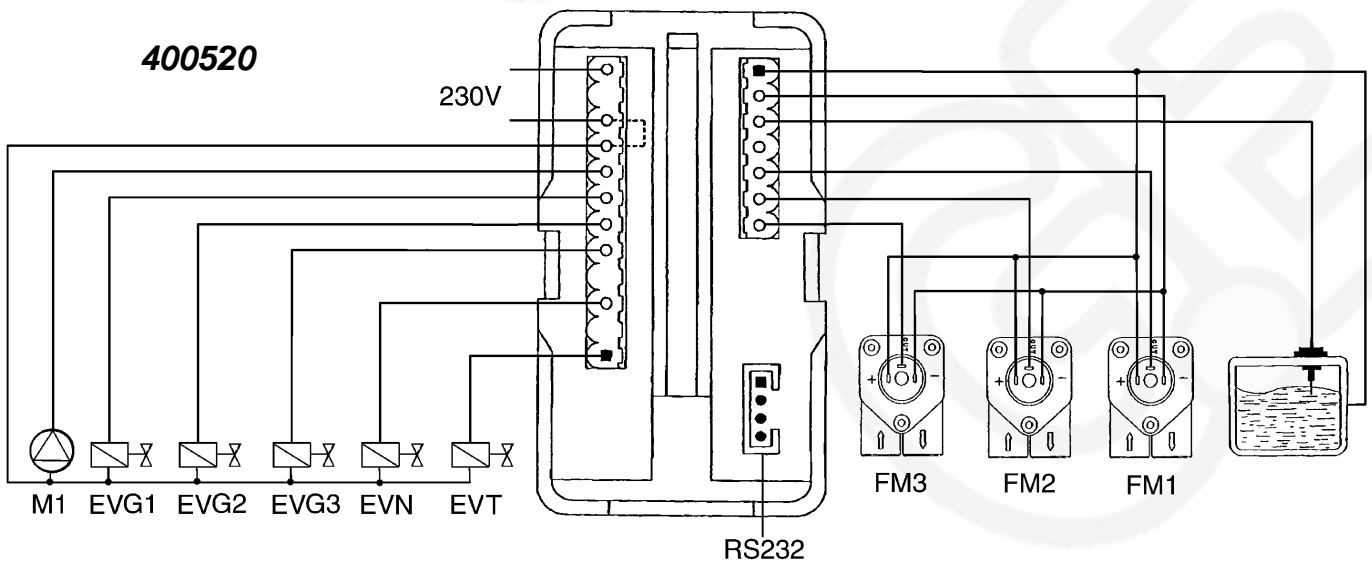

Elektromotoren

Electric engines

Schellenanschluss/Clip connection



Abb. Pict.	Bestell-Nr. Order-No.	Beschreibung Description
1	500061	Motor, 165W/230VAC, mit Anschlusskasten Engine, 165W/230VAC, with connection box
2	500072	Motor, 100W/230VAC Engine, 100W/230VAC



Abb. Pict.	Bestell-Nr. Order-No.	Beschreibung Description
1	500080	Motor, 184W/230VAC Engine, 184W/230VAC
1	500073	Motor, 184W/110VAC Engine, 184W/110VAC
2	500233	Motor, 100W/230VAC Engine, 100W/230VAC

Flanschanschlüsse/Flange connections

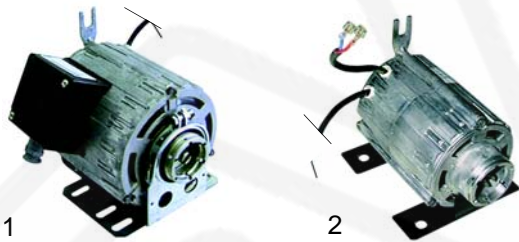

Abb. Pict.	Bestell-Nr. Order-No.	Beschreibung Description
1	500062	Motor, 150W/230VAC Engine, 150W/230VAC
2	500081	Motor, 150W/230VAC, mit Anschlusskasten Engine, 150W/230VAC, with connection box

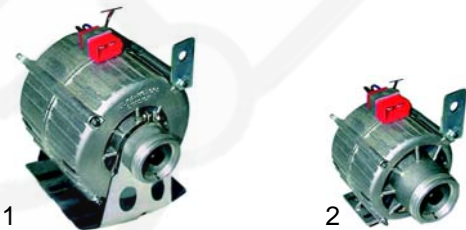

Abb. Pict.	Bestell-Nr. Order-No.	Beschreibung Description	Passend für Suitable for
1	500076	Motor, 170W/230VAC Engine, 170W/230VAC	Faema Express/Compact
2	500077	Motor, 150W/230VAC Engine, 150W/230VAC	Tronic/Star E91/DUE

Pumpen

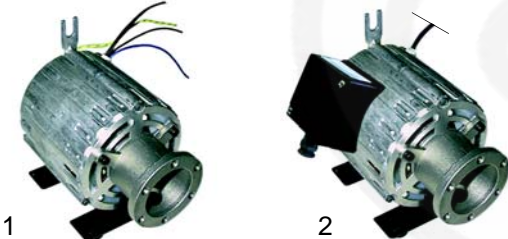
Pumps

Schellenanschluss/Clip connection



Abb. Pict.	B.-Nr. O.-No.	Beschreibung Description	Fabrikat Product	A (mm)
1	500174	Pumpe, 100L/h, 1 bis 2Gr. Pump, 100L/h, 1 to 2 gr.	Rotoflow	82mm
1	500064	Pumpe, 200L/h, 2 bis 4 Gr. Pump, 200L/h, 2 to 4 gr.	Rotoflow	82mm
2	500230	Pumpe, 200L/h, 2 bis 4 Gr. Pump, 200L/h, 2 to 4 gr.	Procon	82mm
3	500126	Pumpe, 100L/h, 1 bis 2 Gr. Pump, 100L/h, 1 to 2 gr.	Rotoflow	53mm
3	500175	Pumpe, 200L/h, 2 bis 4 Gr. Pump, 200L/h, 2 to 4 gr.	Rotoflow	53mm
4	520155	Kupplung Coupling		



Abb. Pict.	B.-Nr. O.-No.	Beschreibung Description	Fabr. Product	A (mm)
1	500176	Pumpe, 100L/h, mit Filter, 1 bis 2Gr. Pump, 100L/h, with filter, 1 to 2 gr.	Rotoflow	82mm
1	500177	Pumpe, 200L/h, mit Filter, 2 bis 4 Gr. Pump, 200L/h, with filter, 2 to 4 gr.	Rotoflow	82mm
2	500068	Pumpe, 300L/h, (CNS/Postmix) Pump, 300L/h, (stainless steel/Postmix)	Rotoflow	82mm

Flanschanschlüsse/Flange connections



Abb. Pict.	Bestell-Nr. Order-No.	Beschreibung Description	Passend für Suitable for
1	500065	Pumpe, 200L/h Pump, 200L/h	
2	500078	Pumpe, 200L/h Pump, 200L/h	Faema

Zubehör Accessories



Abb. Pict.	Bestell-Nr. Order-No.	Beschreibung Description
1	520126	Klemmschelle Clamp
2	520155	Kupplung Coupling
3	520156	Dämmkupplung Dumper coupling
4	520157	Kunststoffadapter für Dämmkupplung Plastic adapter for dumper coupling



Abb. Pict.	Bestell-Nr. Order-No.	Beschreibung Description
1	500066	Kupplung, Flanschanschluss/kpl. Coupling, flange mounting/cpl.
2	520158	Kupplung Coupling
3	365012	Kondensator, 6,3µF (100W Motor) Condensator, 6,3µF (100W engine)
3	365015	Kondensator, 10µF (150W bis 170W Motoren) Condensator, 10µF (150W to 170W engines)
3	365017	Kondensator, 5µF (165W Motoren, Postmixanlagen, 100% ED) Condensator, 5µF (165W engines, Postmix applications, 100% ED)

Vibrationspumpen Vibration pumps

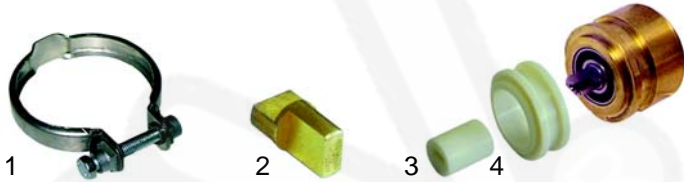
Fluid-o-Tech



Abb. Pict.	Bestell-Nr. Order-No.	Beschreibung Description	Anschlüsse/Connections	
			A	B
1	500123	70W/230VAC	1/8"	1/8"
1	500232	48W/24VAC	1/8"	1/8"
2	500217	70W/230VAC mit By-Pass	1/8"	1/8"

Eaton/Invensys

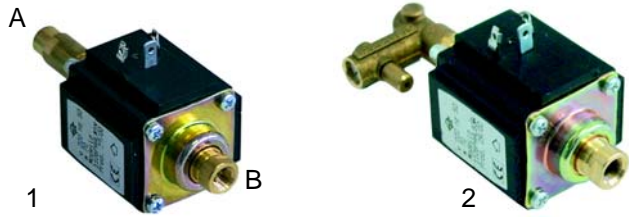

Abb. Pict.	Bestell-Nr. Order-No.	Beschreibung Description	Anschlüsse/Connections	
			A	B
1	500218	CP2, 60W/230VAC	1/8"	1/8"
2	500219	CP3A, 65W/230VAC	1/8"	6mm

Vibropompe

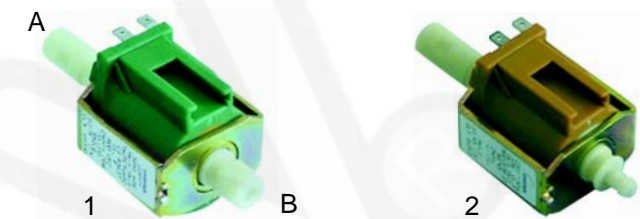

Abb. Pict.	Bestell-Nr. Order-No.	Beschreibung Description	Anschlüsse/Connections	
			A	B
1	500063	VB7, 70W/230VAC	1/8"	1/8"
2	500079	City 1, 60W/230VAC	1/8"	1/8"

Vibrationspumpen Vibration pumps

Ulka

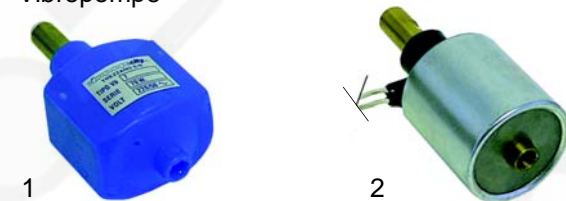

Abb. Pict.	Bestell-Nr. Order-No.	Beschreibung Description	Anschlüsse/Connection	
			A	B
1	500173	EP5/48W/230VAC	1/8"	6mm
1	500178	EP5/48W/24VAC	1/8"	6mm
2	500124	EX5/48W/230VAC	1/8"	6mm
2	500179	EX5/48W/24VAC	1/8"	6mm

Diverse/Divers

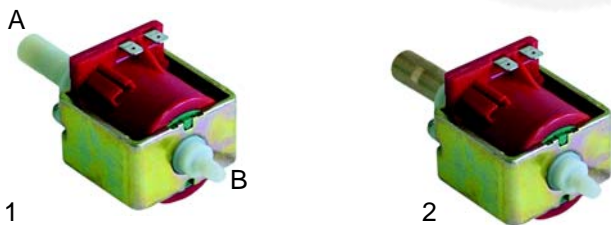

Abb. Pict.	Bestell-Nr. Order-No.	Beschreibung Description	Anschlüsse/Connections	
			A	B
1	500220	Saeco, 70W/230VAC	1/8"	6mm
2	500221	Elmetor, 57W/230VAC	1/8"	1/8"

Vibrationspumpen

Vibration pumps

Zubehör/Accessories



Abb. Pict.	Bestell-Nr. Order-No.	Beschreibung Description
1	520152	Sauganschluss (Santopren) Suction connection (Santopren)
2	520150	Sauganschluss (Messing), 1/8" Suction connection (brass), 1/8"
3	520330	Gummihalter/gerade Rubber holder/straight
4	520153	Gummihalter/gewinkelt Rubber holder/squared
5	520154	Gummihalter/gewinkelt Rubber holder/squared



Abb. Pict.	Bestell-Nr. Order-No.	Beschreibung Description	Anschlüsse/Connection	
			A	B
1	520159	Schlauchverschraubung/gerade Hose bolting/straight	1/8"	6mm
2	520247	Schlauchverschraubung Hose bolting	1/8"	4mm
3	520248	Einschraubtülle Srew in socket	1/8"	6mm
4	520250	By-Pass By-Pass	1/8"	M12x1

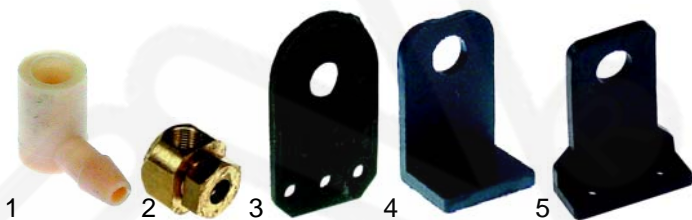

Abb. Pict.	Bestell-Nr. Order-No.	Beschreibung Description
1	371120	Diode Diode
2	371090	Stecker Plug

Schalter

Switches

Hauptschalter/Main switches

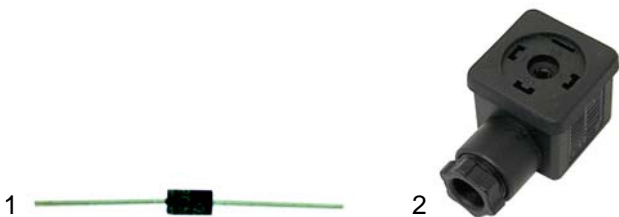

Abb. Pict.	Bestell-Nr. Order-No.	Beschreibung Description
1	346004	0 - I, 2-polig, 20A/0 - I, 2 poles, 20A
2	346013	0 - I, 2-polig, 25A/0 - I, 2 poles, 25A
3	346090	0 - I, 2-polig, 25A/0 - I, 2 poles, 25A



Abb. Pict.	Bestell-Nr. Order-No.	Beschreibung Description
1	346104	0 - I, 3-polig, 20A/0 - I, 3 poles, 20A
2	346014	0 - I, 3-polig, 25A/0 - I, 3 poles, 25A
3	346105	0 - I, 3-polig, 32A/0 - I, 3 poles, 32A



Abb. Pict.	Bestell-Nr. Order-No.	Beschreibung Description
1	346071	0 - I, 4-polig, 16A/0 - I, 4 poles, 16A
2	346069	0 - I, 4-polig, 25A/0 - I, 4 poles, 25A

Schalter Switches

Wippenschalter, 2-pol Schließer/
Cradle switches, DPST-NO



Abb. Pict.	Bestell-Nr. Order-No.	Beschreibung Description	Farbe Colour
1	301003	16A/250V, 30 x 22mm	Grün/Green
2	301002	16A/250V, 30 x 22mm	Gelb/Yellow
3	301001	16A/250V, 30 x 22mm	Red/Red
4	301009	16A/250V, 30 x 22mm	Klar/Clear

Wippenumschalter, 2-pol Wechsler/
Cradle switches, DPDT

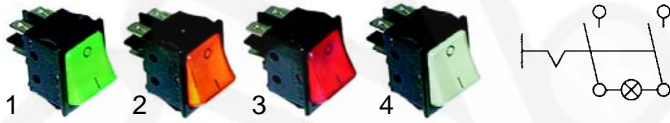

Abb. Pict.	Bestell-Nr. Order-No.	Beschreibung Description	Farbe Colour
1	301017	16A/250V, 30 x 22mm	Grün/Green
2	301016	Gelb, 16A/250V, 30 x 22mm	Gelb/Yellow
3	301015	Rot, 16A/250V, 30 x 22mm	Red/Red
4	301081	Klar, 16A/250V, 30 x 22mm	Klar/Clear

Wippentaster, 2-pol Schließer/
Cradle push button, DPST-NO

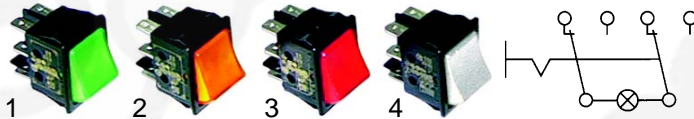

Abb. Pict.	Bestell-Nr. Order-No.	Beschreibung Description	Farbe Colour
1	301019	16A/250V, 30 x 22mm	Grün/Green
2	301018	16A/250V, 30 x 22mm	Gelb/Yellow
3	301020	16A/250V, 30 x 22mm	Red/Red
4	301085	16A/250V, 30 x 22mm	Klar/Clear

Wippenschalter, 2-pol Schließer/
Cradle switches, DPST-NO

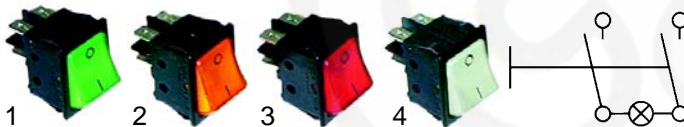

Abb. Pict.	Bestell-Nr. Order-No.	Beschreibung Description	Farbe Colour
1	301062	16A/250V, 30 x 22mm	Grün/Green
2	301061	16A/250V, 30 x 22mm	Gelb/Yellow
3	301060	16A/250V, 30 x 22mm	Red/Red

Wippenschalter, beleuchtet (gelb) mit Symbolen/
Cradle switches, lighted (yellow) with symbols



Abb. Pict.	Bestell-Nr. Order-No.	Beschreibung Description	Symbol Colour
1	346108	16A/250V, 30 x 22mm	Blitz/Flash
2	346109	16A/250V, 30 x 22mm	Wasser/Water
3	346110	16A/250V, 30 x 22mm	Kaffee/Coffee

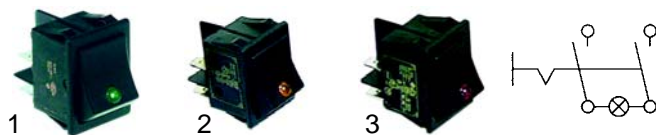

Abb. Pict.	Bestell-Nr. Order-No.	Beschreibung Description	Farbe Colour
1	346111	16A/250V, 30 x 22mm	Tassenwärmer/ Cups warmer
2	346164	16A/250V, 30 x 22mm	Dampf/Steam

Wippenschalter, 1-pol Schließer/
Cradle switches, SPST-NO

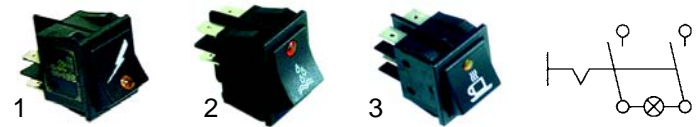

Abb. Pict.	Bestell-Nr. Order-No.	Beschreibung Description	Farbe Colour
1	301012	16A/250V, 30 x 11mm	Grün/Green
2	301011	16A/250V, 30 x 11mm	Gelb/Yellow
3	301010	16A/250V, 30 x 11mm	Red/Red
4	301053	16A/250V, 30 x 11mm	Klar/Clear

Wippenschalter, 1-pol Schließer/
Cradle switches, SPST-NO



Abb. Pict.	Bestell-Nr. Order-No.	Beschreibung Description	Farbe Colour
1	301038	16A/250V, 30 x 11mm	Grün/Green
2	301037	16A/250V, 30 x 11mm	Gelb/Yellow
3	301039	16A/250V, 30 x 11mm	Red/Red

Schutzhauben/Protective covers

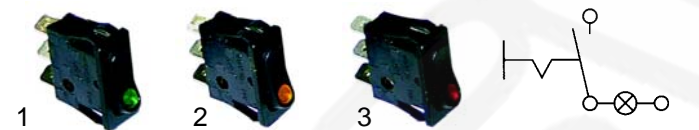

Abb. Pict.	Bestell-Nr. Order-No.	Beschreibung Description
1	301035	Für Schalter, 30 x 11mm/For switches, 30 x 11mm
2	301036	Für Schalter, 30 x 22mm/For switch, 30 x 22mm

Schalter

Switches

Wippenschalter, 2-pol Schließer/
Cradle switches, DPST-NO



Abb. Pict.	Bestell-Nr. Order-No.	Beschreibung Description	Farbe Colour
1	345278	16A/250V, 26,5 x 25,6mm	Grün/Green
2	345277	16A/250V, 26,5 x 25,6mm	Gelb/Yellow
3	345013	16A/250V, 26,5 x 25,6mm	Red/Red

Wippenumschalter, 2-pol Wechsler/
Cradle switches, DPDT

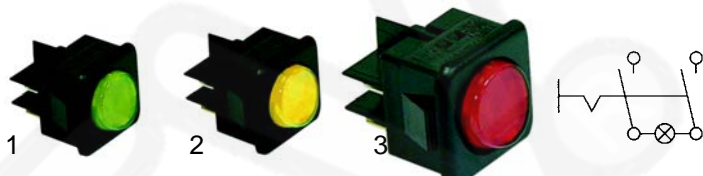

Abb. Pict.	Bestell-Nr. Order-No.	Beschreibung Description	Farbe Colour
1	345280	16A/250V, 26,5 x 25,6mm	Grün/Green
2	345281	16A/250V, 26,5 x 25,6mm	Gelb/Yellow
3	345282	16A/250V, 26,5 x 25,6mm	Red/Red

Wippenschalter, unbeleuchtet, 16A/250V/
Cradle switches, unlit, 16A/250V



Pos. Item	Bestell-Nr. Order-No.	Beschreibung Description
1	301025	Funktion/2-pol Schließer, 28 x 24mm Function/DPST-NO, 28 x 24mm



Abb. Pict.	Bestell-Nr. Order-No.	Beschreibung Description
1	345002	Funktion/2-pol Wechsler, 26,5 x 25,6mm Function/DPDT, 26,5 x 25,6mm
2	301004	Funktion/2-pol Wechsler, 30 x 22mm Function/DPDT, 30 x 22mm

Wippenschalter, unbeleuchtet/
Cradle switches, unlit



Abb. Pict.	Bestell-Nr. Order-No.	Beschreibung Description	Farbe Colour
1	346061	16A/250V, 35 x 20mm, Faston 4,8mm	Rot/Red
2	346074	16A/250V, 35 x 20mm, Faston 6,3mm	Rot/Red

Druckschalter, 2-pol Schließer/
Push switches, DPST-NO

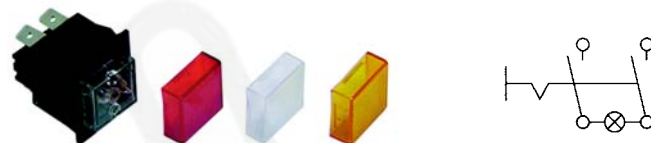

Pos. Item	Bestell-Nr. Order-No.	Beschreibung Description
1	345033	Mit 3 Farben, 16A/250V, 27,2 x 22,2mm With 3 colours, 16A/250V, 27,2 x 22,2mm

Drucktaster, 2-pol Schließer/
Push switches (momentary), DPST-NO

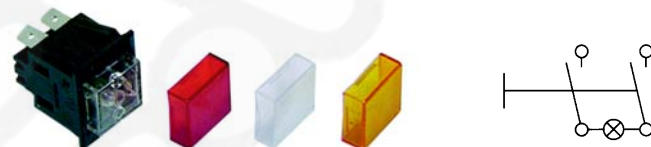

Pos. Item	Bestell-Nr. Order-No.	Beschreibung Description
1	345090	Mit 3 Farben, 16A/250V, 27,2 x 22,2mm With 3 colours, 16A/250V, 27,2 x 22,2mm

Druckschalter, 2-pol Schließer/
Push switches, DPST-NO



Abb. Pict.	Bestell-Nr. Order-No.	Beschreibung Description	Farbe Colour
1	345161	16A/250V, Ø25mm	Grün/Green
2	345162	16A/250V, Ø25mm	Gelb/Yellow
3	345160	16A/250V, Ø25mm	Red/Red

Drucktaster, 2-pol Schließer/
Push switches (momentary), DPST-NO



Pos. Item	Bestell-Nr. Order-No.	Beschreibung Description
1	345038	Schwarz, 16A/250V, Ø25mm Black, 16A/250V, Ø25mm

Schalter

Switches

Druckschalter, 2-pol Schließer/
Push switches, DPST-NO



Abb. Pict.	Bestell-Nr. Order-No.	Beschreibung Description
1	345037	Rot, 16A/250V, Ø25mm Red, 16A/250V, Ø25mm
2	345212	Weiß, 16A/250V, Ø25mm White, 16A/250V, Ø25mm

Mikroschalter, 2-pol Schließer/
Microswitches, DPST-NO



Abb. Pict.	Bestell-Nr. Order-No.	Beschreibung Description
1	345105	16A/250V/16A/250V
2	345032	M10 x 0,75/M10 x 0,75
3	345104	M10 x 0,75, mit Rolle/M10 x 0,75, with roller



Abb. Pict.	Bestell-Nr. Order-No.	Beschreibung Description	L in mm L in mm
1	345041	Mit Rolle/with roller	20,5
1	345252	Mit Rolle/with roller	25
1	345253	Mit Rolle/with roller	30
1	345250	Mit Rolle/with roller	34,5
1	345251	Mit Rolle/with roller	40
2	345256	Mit Hebel/with lever	26,5
2	345257	Mit Hebel/with lever	31,5
2	345255	Mit Hebel/with lever	36
2	345254	Mit Hebel/with lever	70,5
2	345107	Mit Hebel/with lever	77

Schalter

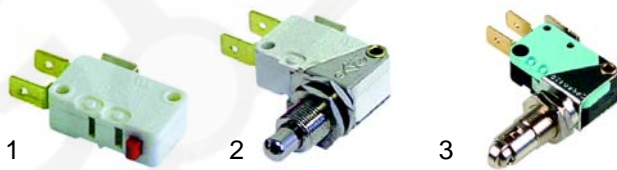
Switches

Mikroschalter, 2-pol Schließer/
Microswitches, DPST-NO



Abb. Pict.	Bestell-Nr. Order-No.	Beschreibung Description	L in mm L in mm
1	345156	M10 x 1/M10 x 1	
2	345266	Mit Rolle/with roller	34,5
2	345045	Mit Rolle/with roller	50,5
2	345267	Mit Rolle/with roller	60
3	345268	Mit Hebel/with lever	38
3	345269	Mit Hebel/with lever	54
3	345125	Mit Hebel/with lever	63,5
3	345044	Mit Hebel/with lever	72

Lampen

Lamps

Einsteckfassung/Insert socket



Abb. Pict.	Bestell-Nr. Order-No.	Einbaumaß Fitting dimensions	Farbe Colour
1	359123	10mm	grün/green
2	359124	10mm	gelb/yellow
3	359125	10mm	rot/red
4	359228	10mm	klar/clear



Abb. Pict.	Bestell-Nr. Order-No.	Einbaumaß Fitting dimensions	Farbe Colour
1	359262	12mm	grün/green
2	359260	12mm	gelb/yellow
3	359261	12mm	rot/red

Signallampen

Signal lamps



Abb. Pict.	Bestell-Nr. Order-No.	Beschreibung Description	Einbaumaß Fitting dim.	Farbe Colour
1	359136	Faston 6,3mm	9mm	grün/green
2	359137	Faston 6,3mm	9mm	gelb/yellow
3	359135	Faston 6,3mm	9mm	rot/red
4	359134	Faston 6,3mm	9mm	klar/clear



Abb. Pict.	Bestell-Nr. Order-No.	Beschreibung Description	Einbaumaß Fitting dim.	Farbe Colour
1	359139	Faston 6,3mm	10mm	grün/green
2	359140	Faston 6,3mm	10mm	gelb/yellow
3	359138	Faston 6,3mm	10mm	rot/red
4	359036	Faston 6,3mm	10mm	klar/clear

Signalelement

Signal element



Abb. Pict.	Bestell-Nr. Order-No.	Beschreibung Description
1	359129	24V/Faston 6,3mm
1	359130	230V/Faston 6,3mm
1	359131	400V/Faston 6,3mm
2	359430	230V/mit Kabel/with cable
1	359222	24V/Faston 6,3mm
1	359132	230V/Faston 6,3mm
1	359133	400V/Faston 6,3mm
2	359431	230V/mit Kabel/with cable

Nur für grüne Fassungen
Only for green sockets



Abb. Pict.	Bestell-Nr. Order-No.	Beschreibung Description	Einbaumaß Fitting dim.	Farbe Colour
1	359041	Faston 6,3mm	12mm	grün/green
2	359042	Faston 6,3mm	12mm	gelb/yellow
3	359043	Faston 6,3mm	12mm	rot/red
4	359044	Faston 6,3mm	12mm	klar/clear



Abb. Pict.	Bestell-Nr. Order-No.	Beschreibung Description	Einbaumaß Fitting dim.	Farbe Colour
1	359142	Faston 6,3mm	13mm	grün/green
2	359143	Faston 6,3mm	13mm	gelb/yellow
3	359141	Faston 6,3mm	13mm	rot/red
4	359045	Faston 6,3mm	13mm	klar/clear

Verbinder/PVC-isoliert Connectors/PVC insulated

Technische Daten:

VPE: 100 Stück
Material: Messing/verzinnt
Temperatur: Max. 80°C
Klemmbereich: I 0,5 bis 1,5mm²
 I 1,5 bis 2,5mm²
 I 4,0 bis 6,0mm²

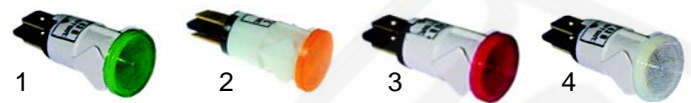
Tecnical data:

Pack: 100 pieces
Material: Brass/tinned
Temperature: Max. 80°C
Grip surface: I 0,5 to 1,5mm²
 I 1,5 to 2,5mm²
 I 4,0 to 6,0mm²

Flachsteckhülsen/Flat socket jack



Pos. Item	B.-Nr. O.-No.	Größe Size
1	550150	2,8 x 0,8mm I
2	550255	2,8 x 0,8mm I
3	550151	4,8 x 0,8mm I
4	550152	4,8 x 0,8mm I

Pos. Item	B.-Nr. O.-No.	Größe Size
5	550153	6,3 x 0,8mm I
6	550154	6,3 x 0,8mm I
7	550155	6,3 x 0,8mm I

Flachsteckhülsen mit Abzweig/ Flat socket jacks with connection



Pos. Item	B.-Nr. O.-No.	Größe Size
1	550156	6,3 x 0,8mm I
2	550157	6,3 x 0,8mm I

Pos. Item	B.-Nr. O.-No.	Größe Size
3	550282	6,3 x 0,8mm I

Flachsteckhülsen (voll isoliert)/ Flat socket jacks (completely insulated)



Pos. Item	B.-Nr. O.-No.	Größe Size
1	550283	2,8 x 0,8mm I
2	550290	2,8 x 0,8mm I
3	550235	4,8 x 0,8mm I
4	550236	4,8 x 0,8mm I

Pos. Item	B.-Nr. O.-No.	Größe Size
5	550178	6,3 x 0,8mm I
6	550179	6,3 x 0,8mm I
7	550291	6,3 x 0,8mm I

Flachstecker/Flat plug



Pos. Item	B.-Nr. O.-No.	Größe Size
1	550292	2,8 x 0,8mm I
2	550293	2,8 x 0,8mm I
3	550294	4,8 x 0,8mm I
4	550295	4,8 x 0,8mm I

Pos. Item	B.-Nr. O.-No.	Größe Size
5	550296	6,3 x 0,8mm I
6	550297	6,3 x 0,8mm I
7	550615	6,3 x 0,8mm I

Rundsteckhülsen/-Stecker, Ø 4/5mm Circular cap jack/-plug Ø 4/5mm



Abb. Pict.	Bestell-Nr. Order-No.	Ø
1	550196	4mm I
1	550197	4mm I
1	550616	5mm I
1	550617	5mm I

Abb. Pict.	Bestell-Nr. Order-No.	Ø
2	550187	4mm I
2	550188	4mm I
2	550618	5mm I
2	550619	5mm I

Stiftkabelschuhe/Terminals



Rund/Round

Flach/Flat

Abb. Pict.	B.-Nr. O.-No.	Länge Length
1	550168	12mm I
1	550169	12mm I
1	550170	12mm I

Abb. Pict.	B.-Nr. O.-No.	Länge Length
2	550620	14mm I
2	550621	13mm I
2	550622	18mm I

Ringkabelschuhe/Ring terminals



Pos. Item	B.-Nr. O.-No.	Größe Size	Gr
1	550161	3,2mm	M3 I
2	550623	3,2mm	M3 I
3	550624	3,7mm	M3,5 I
4	550625	3,7mm	M3,5 I
5	550626	3,7mm	M3,5 I
6	550162	4,3mm	M4 I
7	550163	4,3mm	M4 I
8	550627	4,3mm	M4 I

Abb. Pict.	B.-Nr. O.-No.	Größe Size	Gr
9	550628	5,3mm	M5 I
10	550164	5,3mm	M5 I
11	550165	5,3mm	M5 I
12	550629	6,5mm	M6 I
13	550166	6,5mm	M6 I
14	550167	6,5mm	M6 I
15	550630	8,4mm	M8 I
16	550631	8,4mm	M8 I

Gabelkabelschuhe/Spate terminals



Pos. Item	B.-Nr. O.-No.	Größe Size	Gr
1	550632	3,2mm	M3 I
1	550633	3,2mm	M3 I
1	550634	3,7mm	M3,5 I
1	550635	3,7mm	M3,5 I
1	550636	3,7mm	M3,5 I
1	550172	4,3mm	M4 I
1	550173	4,3mm	M4 I
1	550637	4,3mm	M4 I

Abb. Pict.	B.-Nr. O.-No.	Größe Size	Gr
2	550638	5,3mm	M5 I
2	550174	5,3mm	M5 I
2	550175	5,3mm	M5 I
2	550274	6,5mm	M6 I
2	550176	6,5mm	M6 I
2	550177	6,5mm	M6 I
2	550640	8,4mm	M8 I

Verbinder/Nylon Connectors/Nylon

Technische Daten:

VPE: 100 Stück
Material: Messing/verzinnt
Isolierung: Nylon
Temperatur: Max. 120°C
Klemmbereich: 1 0,5 bis 1,5mm²
 1 1,5 bis 2,5mm²
 1 4,0 bis 6,0mm²

Technical data:

Pack: 100 pieces
Material: Brass/tined
Insulation: Nylon
Temperature: Max. 120°C
Grip surface: 1 0,5 to 1,5mm²
 1 1,5 to 2,5mm²
 1 4,0 to 6,0mm²



1

Stecker/Plug



2

Steckhülse/Socket jack

Pos. Item	B.-Nr. O.-No.	Größe Size	Klemmbereich Grip surface
1	550237	6,3 x 0,8mm	1
1	550238	6,3 x 0,8mm	1
1	550644	6,3 x 0,8mm	1

Pos. Item	B.-Nr. O.-No.	Größe Size	Klemmbereich Grip surface
2	550641	6,3 x 0,8mm	1
2	550642	6,3 x 0,8mm	1
2	550643	6,3 x 0,8mm	1

Verbinder/unisoliert Connectors/not insulated

Technische Daten:

VPE: 100 Stück
Material: Messing/verzinnt
Temperatur: Max. 110°C

Technical data:

Pack: 100 pieces
Material: Brass/tined
Temperature: Max. 110°C

Flachsteckhülse/Flat socket jacks



Pos. Item	Bestell-Nr. Order-No.	Größe Size	Klemmbereich Grip surface
1	550650	2,8 x 0,8mm	0,5 - 1mm ²
2	550651	4,8 x 0,8mm	0,5 - 1mm ²
3	550652	4,8 x 0,8mm	1,0 - 2,5mm ²
4	550653	6,3 x 0,8mm	0,5 - 1mm ²
5	550654	6,3 x 0,8mm	1 - 2,5mm ²
6	550655	6,3 x 0,8mm	2,5 - 6mm ²



Abb. Pict.	B.-Nr. O.-No.	Beschreibung Description	Größe Size	Klemmbereich Grip surface
1	550656	Flachstecker Flat plug	6,3 x 0,8mm	1,0 - 2,5mm ²
2	550657	Flachsteckhülse/ gewinkelt Flat socket jack/ angled	6,3 x 0,8mm	1,0 - 2,5mm ²
3	550658	Flachsteckhülse mit Abzweig Flat socket jacks with connection	6,3 x 0,8mm	1,0 - 2,5mm ²

Flachsteckhülse (Sicherheitssystem)/ Flat socket jacks (Safety system)



Pos. Item	Bestell-Nr. Order-No.	Größe Size	Klemmbereich Grip surface
1	550659	4,8 x 0,8mm	0,5 - 1mm ²
2	550660	4,8 x 0,8mm	1,0 - 2,5mm ²
3	550661	6,3 x 0,8mm	0,5 - 1mm ²
4	550279	6,3 x 0,8mm	1,0 - 2,5mm ²

Verbinder/unisoliert Connectors/not insulated

Technische Daten:

VPE: 100 Stück
Material: Stahl/vernickelt
Temperatur: Max. 450°C

Technical data:

Pack: 100 pieces
Material: Steel/nickled
Temperature: Max. 450°C

Ringkabelschuhe/Ring terminals



Pos. Item	Bestell-Nr. Order-No.	D1/ mm	D2/ mm	Klemmbereich Grip surface
1	550007	4,3	8	0,5 - 1mm ²
2	550008	4,2	8,6	0,75 - 2,5mm ²
3	550009	5,3	8,6	0,75 - 2,5mm ²
4	550010	6,2	8,6	0,75 - 2,5mm ²

Flachsteckhülse/Flat socket jacks



Abb. Pict.	Bestell-Nr. Order-No.	Beschreibung Description	Klemmbereich Grip surface
1	550001	Gerade/Straight	1,0 - 2,5mm ²
2	550012	Mit Abzweig/with connection	1,0 - 2,5mm ²
3	550013	Verteiler/Distributor	-
4	550198	Gewinkelt/Angled	1,0 - 2,5mm ²

Schutzhüllen

Protection cover

Technische Daten:

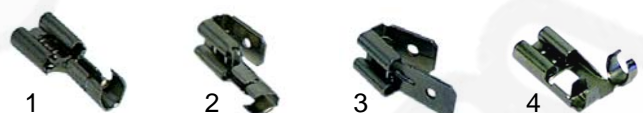
VPE: 20 Stück
Material: Nylon
Isolierung: Nylon
Temperatur: Max. 120°C

Tecnical data:

Pack: 20 pieces
Material: Nylon
Insulation: Nylon
Temperature: Max. 120°C



Abb. Pict.	Bestell-Nr. Order-No.	Beschreibung Description	Größe Size
1	550665	2,8	gerade/straight
1	550666	4,8	gerade/straight
1	550331	6,3	gerade/straight
2	550332	6,3	gewinkelt/angled
3	550667	6,3	Für Stecker/for plug

Aderendhülsen/isoliert

Tail conductor jacks/insulated

Technische Daten:

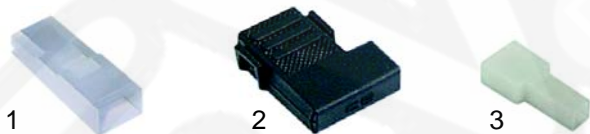
VPE: 100 Stück
Material: Kupfer/verzinnt
Isolierung: Nylon
Temperatur: Max. 110°C

Tecnical data:

Pack: 100 pieces
Material: Copper/tined
Insulation: Nylon
Temperature: Max. 110°C



Pos. Item	B.-Nr. O.-No.	Größe Size	L
1	550189	0,75mm ²	10mm
2	550190	1,0mm ²	10mm
3	550191	1,5mm ²	10mm
4	550192	2,5mm ²	12mm

Pos. Item	B.-Nr. O.-No.	Größe Size	L
5	550193	4mm ²	12mm
6	550194	6mm ²	12mm
7	550195	10mm ²	15mm

Aderendhülsen/unisoliert

Tail conductor jacks/not insulated

Technische Daten:

VPE: 100 Stück
Material: Kupfer/verzinnt
Temperatur: Max. 110°C

Tecnical data:

Pack: 100 pieces
Material: Copper/tined
Temperature: Max. 110°C



Pos. Item	B.-Nr. O.-No.	Größe Size	L
1	550180	0,75mm ²	8mm
2	550181	1,0mm ²	10mm
3	550182	1,5mm ²	10mm
4	550183	2,5mm ²	12mm

Pos. Item	B.-Nr. O.-No.	Größe Size	L
5	550184	4mm ²	12mm
6	550185	6mm ²	12mm
7	550186	10mm ²	15mm

Quetschklemmen

Pressing grips

Technische Daten:

VPE: 10 Stück
Material: Stahl/verzinnt
Isolierung: Nylon
Temperatur: Max. 110°C

Tecnical data:

Pack: 10 pieces
Material: Steel/tined
Insulation: Nylon
Temperature: Max. 110°C



Abb. Pict.	B.-Nr. O.-No.	Klemmbereich Grip surface
1	550018	4mm ²
2	550033	5mm ²

Isolierbänder (VDE)

Insulating tapes (VDE)



Pos. Item	Bestell-Nr. Order-No.	Breite Width	Länge Length	Farbe Colour
1	550021	15 mm	10 m	schwarz
2	550032	15 mm	10 m	gelb/grün
3	550023	15 mm	10 m	blau
4	550022	15 mm	10 m	weiß
5	550025	15mm	10m	grau
6	550024	15mm	10m	rot
7	550026	15mm	10m	grün

Nylon-Kabelbinder/Socket/

Nylon cable connectors/bases

100Stck./VPE/100pcs./pack



Abb. Pict.	Bestell-Nr. Order-No.	Breite Width	Länge Length
1	550249	Klebe-Sockel	----
2	550250	2,5 mm	100 mm
3	550251	2,5 mm	160 mm
4	550254	3,6 mm	140 mm
5	550252	3,6 mm	200 mm
6	550253	3,6 mm	290 mm

Heizkörper

Heaters

Abkürzungen:

Heizkreise:	HK
Heizkreise/Spannung:	U
Gesamtleistung:	P
Eintauchtiefe:	ET
Tauchhöhe:	TH
Tauchhülse:	T

Abridgements:

Heating circuits:	HK
Heating circuits/Voltage:	U
Total power:	P
Immersion depth:	ET
Immersion height:	TH
Immersion socket:	T

Einschraub-Tauchheizkörper, 1" Immersion heating body with thread, 1"



Pos. Item	B.-Nr. O.-No.	HK	U (V)	P (W)	ET (mm)	T (mm)	Passend für Suitable for
1	417049	1	230	1350	160	6,5	Bezzera
2	417081	1	230	1350	140	-	Brasilia, Vibiemme
3	415216	1	230	1200	165	-	
4	415200	1	230	1000	165	-	

Einschraub-Tauchheizkörper, 1¼" Immersion heating body with thread, 1¼"



Pos. Item	B.-Nr. O.-No.	HK	U (V)	P (W)	ET (mm)	T (mm)	Passend für Suitable for
1	417089	1	230	1300	98	-	Wega
2	417173	2	230	1700	130	-	Brasilia
3	417057	2	230	1500	145	-	Auora
4	417045	1	230	1500	160	-	Marzocco, Pavoni, Vibiemme
5	417032	1	230	2000	170	-	Brasilia, Vibiemme
6	417046	1	230	2000	200	4,2	Carimali
7	417196	2	230	2400	235	-	Brasilia
8	417062	3	230	3000	240	-	Pavoni
9	417080	2	230	2500	250	-	Marzocco, Brasilia
10	417048	2	230	2400	255	-	Carimali
11	417125	1	230	1500	290	-	Marzocco
12	417063	3	230	4500	300	-	Pavoni
13	417058	2	230	2500	330	-	Aurora
14	417127	1	230	1400	395	-	Marzocco
15	417047	3	230	3000	410	4,2	Marzocco, Carimali

Ovaler Flansch, 58mm/Oval flange, 58mm

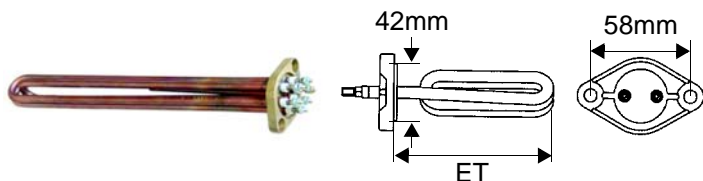

Pos. Item	B.-Nr. O.-No.	HK	U (V)	P (W)	ET (mm)	T (mm)	Passend für Suitable for
1	417185	1	230	2000	180	4	San Marco
2	417029	2	230	3000	345	4	San Marco
3	417186		230	4500		4	San Marco

Ovaler Flansch, 74mm/Oval flange, 74mm

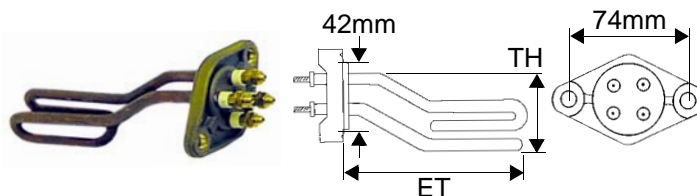

Pos. Item	B.-Nr. O.-No.	HK	U (V)	P (W)	ET (mm)	TH (mm)	T (mm)	Pass. für Suit. for
1	417090	1	230	1500	125	40	-	Wega
2	417002	2	230	1500	145	50	-	Faema
3	417174	3	230	2500	160	55	-	Elektra
4	417043	3	230	1800	165	45	-	Astoria, Wega
5	417039	2	230	2000	180	60	-	Astoria
6	417154	3	230	2700	180	60	-	Wega
7	417116	2	230	1800	240	65	6,5	Faema, Mairali, Futurmat, Italcrem, Visacrem
8	417003	2	230	1800	245	65	-	Faema, Mairali, Futurmat, VFA-Express
9	417111	3	230	3750	290	60	6,5	Faema
10	417107	2	230	2500	300	55	6,5	Faema, Mairali, Futurmat, VFA-Expobar
11	417155	3	230	3000	310	40	-	Elektra, Wega
12	417087	3	230	2500	315	50	-	Astoria
13	417040	2	230	2600	320	50	-	Astoria
14	417042	3	230	2600	320	50	-	Wega
15	417001	2	230	2600	335	55	6,5	Faema, Mairali, Futurmat, Italcrem, VFA-Express, Visacrem
16	417108	2	230	3500	385	60	6,5	Faema
17	417112	3	230	4500	385	60	6,5	Faema
18	417109	2	230	3700	460	60	6,5	Faema, Mairali, Futurmat, talcrem, Visacrem
19	417157	3	230	5000	480	60	-	Wega
20	417064	2	230	3700	515	50	-	Astoria
21	417088	3	230	3700	560	45	-	Astoria
22	417187	2	230	3700	570	60	-	VFA-Express
23	417110	2	230	5000	590	60	6,5	Faema
24	417156	3	230	3700	590	45	-	Wega

Heizkörper

Heaters

Ovaler Flansch mit Loch für Sicherheitsthermostat/
Oval flange with hole for safety thermostat

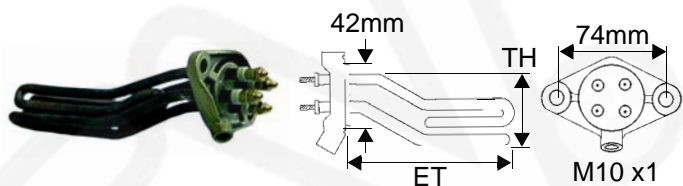

Pos. Item	B.-Nr. O.-No.	HK	U (V)	P (W)	ET (mm)	TH (mm)	T (mm)	Pass. für Suit. for
1	417004	2	230	2400	165	50	-	Faema
2	417103	2	230	2600	390	60	-	Faema
3	417104	2	230	3700	410	60	-	Faema
4	417105	2	230	3700	575	60	-	Faema
5	417106	2	230	5000	575	60	-	Faema

Dreiecksflansch/Triangle flange

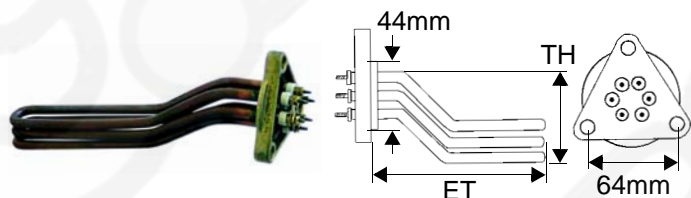

Pos. Item	B.-Nr. O.-No.	HK	U (V)	P (W)	ET (mm)	TH (mm)	T (mm)	Pass. für Suit. for
1	417009	3	230	2100	215	55	-	Rancilio
2	417134	3	230	3000	215	55	-	Rancilio
3	417010	3	230	2700	395	55	-	Rancilio
4	417135		230	3900	395	55	-	Rancilio

Dreiecksflansch mit Loch für Sicherheitsthermostat/
Triangle flange with hole for safety thermostat

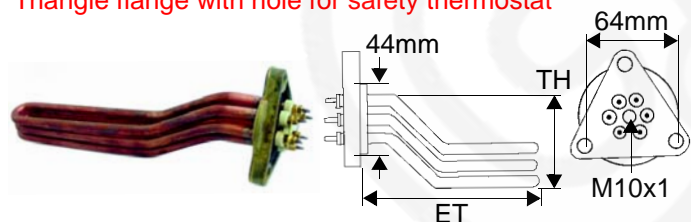

Pos. Item	B.-Nr. O.-No.	HK	U (V)	P (W)	ET (mm)	TH (mm)	T (mm)	Pass. für Suit. for
1	417181	3	230	2100	215	55	-	Rancilio
2	417176	3	230	3000	215	55	-	Rancilio
3	417177	3	230	3000	395	55	-	Rancilio
4	417178	3	230	4300	395	55	-	Rancilio
5	417179	3	230	4300	395	55	4,2	Rancilio

Dreiecksflansch/Triangle flange

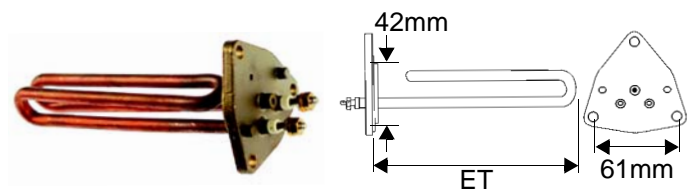

Pos. Item	B.-Nr. O.-No.	HK	U (V)	P (W)	ET (mm)	TH (mm)	T (mm)	Pass. für Suit. for
1	417083	1	230	1500	165	-	-	Faema

Dreiecksflansch/Triangle flange

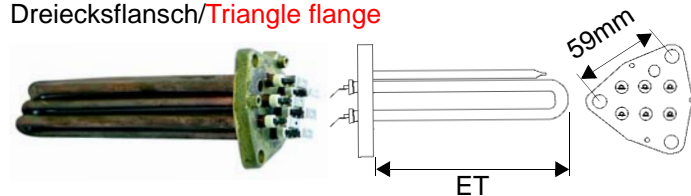

Pos. Item	B.-Nr. O.-No.	HK	U (V)	P (W)	ET (mm)	TH (mm)	T (mm)	Pass. für Suit. for
1	417011	3	230	1800	180	-	-	Cimbali
2	417014	1	230	1300	185	-	-	Cimbali
3	417013	3	230	2850	345	-	-	Cimbali
4	417012	3	230	3750	375	-	6,5	Cimbali
5	417099	3	230	5790	595	-	6,5	Cimbali

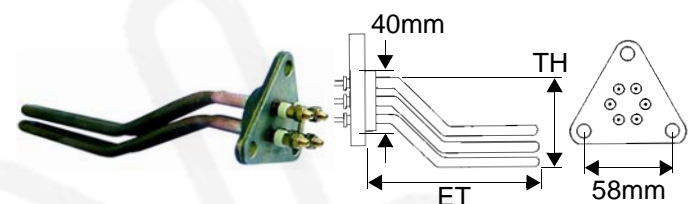

Pos. Item	B.-Nr. O.-No.	HK	U (V)	P (W)	ET (mm)	TH (mm)	T (mm)	Pass. für Suit. for
1	417170	3	230	2000	155	60	-	Brasilia
2	417030	2	230	1800	175	70	-	Brasilia, Vibiemme
3	417171	2	230	3500	330	60	-	Brasilia
4	417031	2	230	3000	345	70	-	Brasilia
5	417172	3	230	5500	455	60	-	Brasilia
6	417096	2	230	4000	495	70	-	Brasilia, Vibiemme
7	417159	2	400	4000	495	70	-	Vibiemme

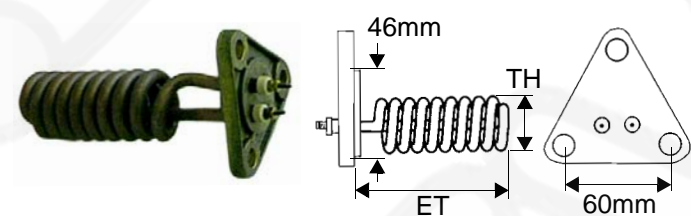

Pos. Item	B.-Nr. O.-No.	HK	U (V)	P (W)	ET (mm)	TH (mm)	T (mm)	Pass. für Suit. for
1	417023	1	230	1750	130	-	-	San Marco

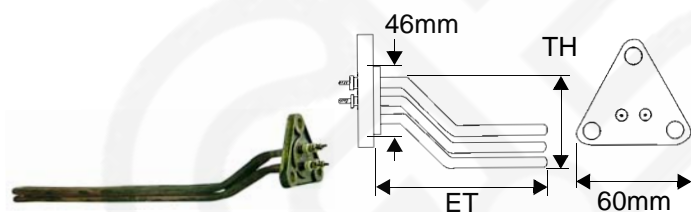

Pos. Item	B.-Nr. O.-No.	HK	U (V)	P (W)	ET (mm)	TH (mm)	T (mm)	Pass. für Suit. for
1	417024	2	230	2600	385	70	-	San Marco
2	417025	3	230	2600	385	70	-	San Marco
3	417028	3	230	3000	375	60	4,5	San Marco
4	417140	2	230	4000	580	65	-	San Marco
5	417141	3	230	4500	580	65	-	San Marco

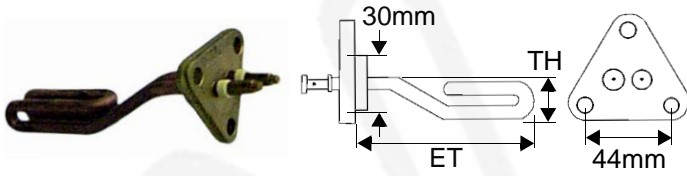

Pos. Item	B.-Nr. O.-No.	HK	U (V)	P (W)	ET (mm)	TH (mm)	T (mm)	Pass. für Suit. for
1	417017	1	230	750	135	35	-	Gaggia
2	417018	1	230	1250	325	35	-	Gaggia
3	417118	1	230	1750	525	35	-	Gaggia

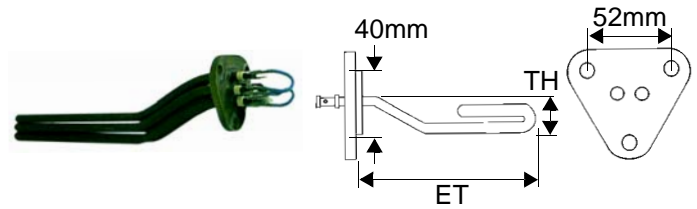

Pos. Item	B.-Nr. O.-No.	HK	U (V)	P (W)	ET (mm)	TH (mm)	T (mm)	Pass. für Suit. for
1	417061	1	230	950	240	45	-	Pavoni
2	417059	3	230	3000	240	45	-	Pavoni
3	417060	3	230	4000	285	45	-	Pavoni
4	417133	1	230	1300	320	55	-	Pavoni
5	417092	2	230	3000	350	50	-	Azkoyen
6	417093	2	230	4000	470	50	-	Azkoyen

Heizkörper Heaters

Dreiecksflansch/Triangle flange

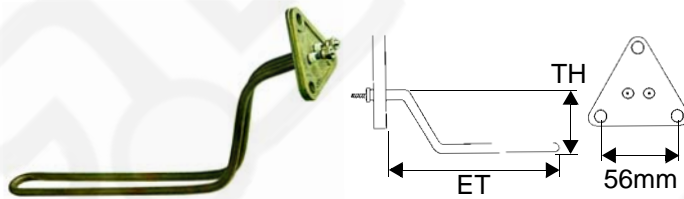

Pos. Item	B.-Nr. O.-No.	HK	U (V)	P (W)	ET (mm)	TH (mm)	T (mm)	Pass. für Suit. for
1	417151	1	230	1300	340	100	-	Visacrem
2	417152	1	230	1900	600	100	-	Visacrem
3	417153	1	400	1900	540	100	-	Visacrem

Dreiecksflansch/Triangle flange

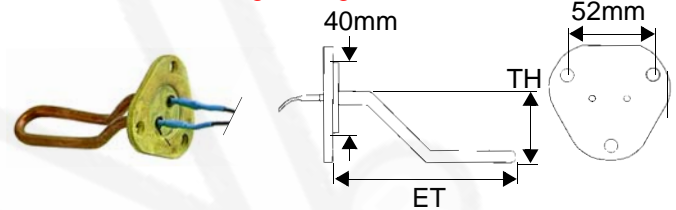

Pos. Item	B.-Nr. O.-No.	HK	U (V)	P (W)	ET (mm)	TH (mm)	T (mm)	Pass. für Suit. for
1	417068	1	230	650	145	40	-	
2	417071	2	230	1350	150	-	-	Marcfi/Ancas
3	417069	1	230	1100	325	40	-	
4	417070	1	230	1350	325	40	-	
5	417073	2	400	3000	340	-	-	
6	417072	2	230	3000	360	-	-	

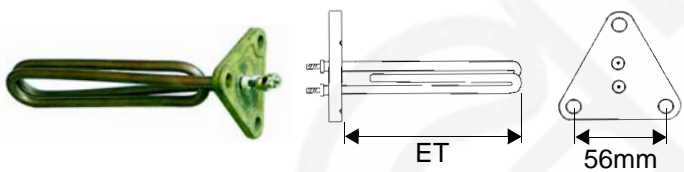

Pos. Item	B.-Nr. O.-No.	HK	U (V)	P (W)	ET (mm)	TH (mm)	T (mm)	Pass. für Suit. for
1	417120	1	230	2500	190	-	-	Italcrem, Visacrem
2	417121	1	230	1000	415	40	-	Italcrem, Visacrem
3	417122	1	230	1500	400	40	-	Italcrem, Visacrem
4	417123	1	230	1500	570	40	-	Italcrem, Visacrem
5	417124	1	230	2500	454	40	-	Italcrem, Visacrem

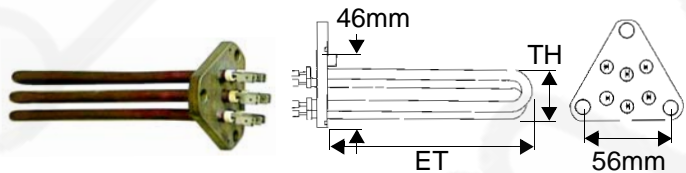

Pos. Item	B.-Nr. O.-No.	HK	U (V)	P (W)	ET (mm)	TH (mm)	T (mm)	Pass. für Suit. for
1	417136	3	230	2100	175	-	-	Reneka
2	417137	3	230	3100	340	-	-	Reneka
3	417138	3	230	5500	465	-	-	Reneka

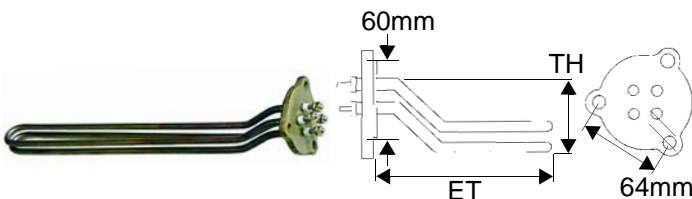

Pos. Item	B.-Nr. O.-No.	HK	U (V)	P (W)	ET (mm)	TH (mm)	T (mm)	Pass. für Suit. for
1	417143	2	230	2500	380	50	-	Solenry
2	417144	2	230	3000	475	50	-	Solenry

Rundflansch/Round flange

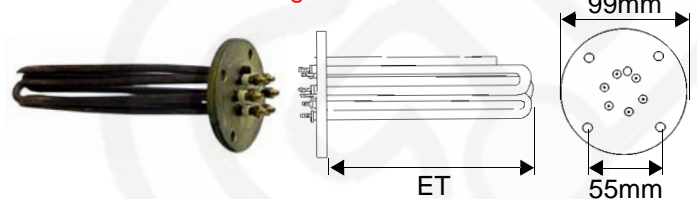

Pos. Item	B.-Nr. O.-No.	HK	U (V)	P (W)	ET (mm)	TH (mm)	T (mm)	Pass. für Suit. for
1	417015	3	230	2700	230	-	6,5	Cimbali
2	417098	3	230	5000	360	-	6,5	Cimbali
3	417016	2	230	4000	475	50	-	Cimbali

Heizkörper

Heaters

Rundflansch/Round flange

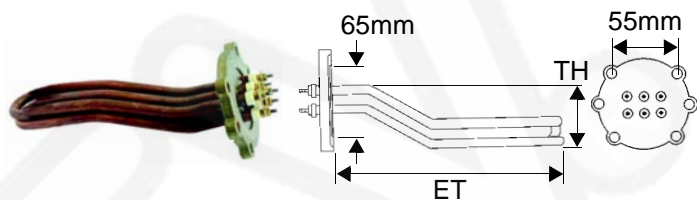

Pos. Item	B.-Nr. O.-No.	HK	U (V)	P (W)	ET (mm)	TH (mm)	T (mm)	Pass. für Suit. for
1	417131	3	230	2700	180	60	-	Nuova Simonelli
2	417182	3	230	400	340	-	-	Nuova Simonelli
3	417184	3	203	4500	340	60	-	Nuova Simonelli

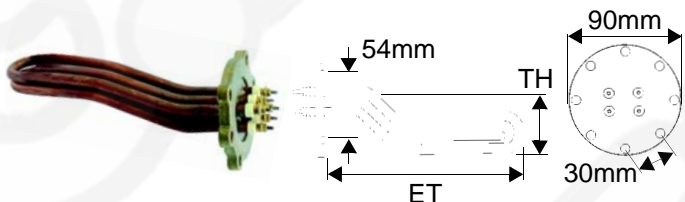

Pos. Item	B.-Nr. O.-No.	HK	U (V)	P (W)	ET (mm)	TH (mm)	Passend für Suitable for
1	417052	2	230	1800	180	55	Nuova Simonelli
2	417053	3	230	3400	340	55	Nuova Simonelli
3	417130	3	230	5000	520	-	Nuova Simonelli

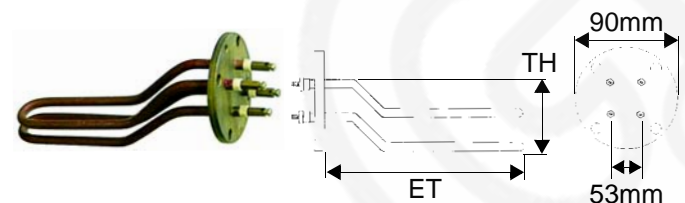

Pos. Item	B.-Nr. O.-No.	HK	U (V)	P (W)	ET (mm)	TH (mm)	T (mm)	Pass. für Suit. for
1	417055	2	230	2000	215	60	-	Auora
2	417056	2	230	2500	360	75	-	Auora
3	417091	2	230	4000	560	75	-	Auora

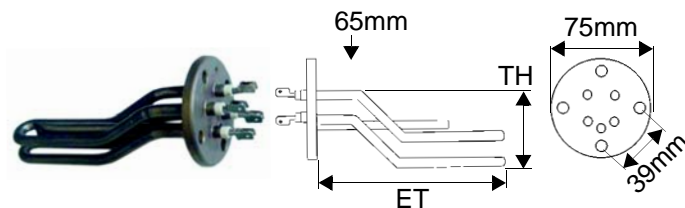

Pos. Item	B.-Nr. O.-No.	HK	U (V)	P (W)	ET (mm)	TH (mm)	T (mm)	Pass. für Suit. for
1	417050	2	230	2000	145	55	7,0	Bezzera
2	417163	2	230	2730	230	55	7,0	Bezzera
3	417051	2	230	3000	345	55	7,0	Bezzera
4	417094	2	230	5000	535	55	7,0	Bezzera

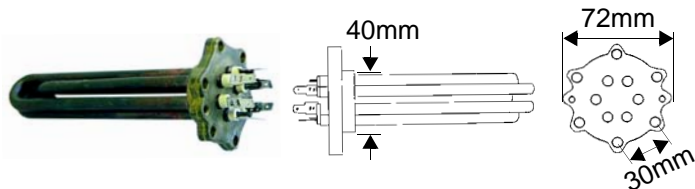

Pos. Item	B.-Nr. O.-No.	HK	U (V)	P (W)	ET (mm)	TH (mm)	T (mm)	Pass. für Suit. for
1	417021	3	230	1500	145	-	-	Gaggia
2	417022	3	230	2000	245	-	-	Gaggia

Rundflansch/Round flange

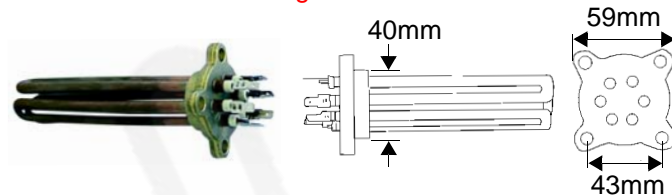

Pos. Item	B.-Nr. O.-No.	HK	U (V)	P (W)	ET (mm)	TH (mm)	T (mm)	Pass. für Suit. for
1	417019	3	230	2000	155	-	-	Gaggia
2	417020	3	230	4000	325	-	-	Gaggia
3	417119	3	230	5000	410	-	-	Gaggia

Rundflansch/Round flange

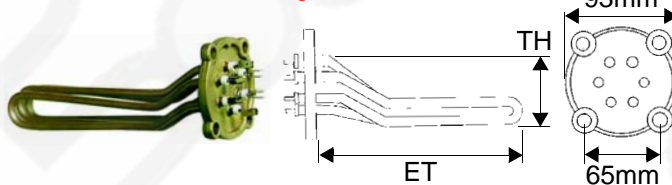

Pos. Item	B.-Nr. O.-No.	HK	U (V)	P (W)	ET (mm)	TH (mm)	T (mm)	Pass. für Suit. for
1	417100	3	230	2800	235	65	-	Conti
2	417101	3	230	5000	480	65	-	Conti

Quadratflansch/Square flange

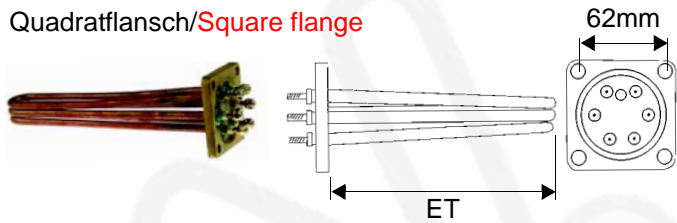

Pos. Item	B.-Nr. O.-No.	HK	U (V)	P (W)	ET (mm)	TH (mm)	T (mm)	Pass. für Suit. for
1	417148	3	230	2500	235	-	6,5	Unic
2	417149	3	230	4000	280	-	6,5	Unic

Mit Zweilochbefestigung/With two hole fixing

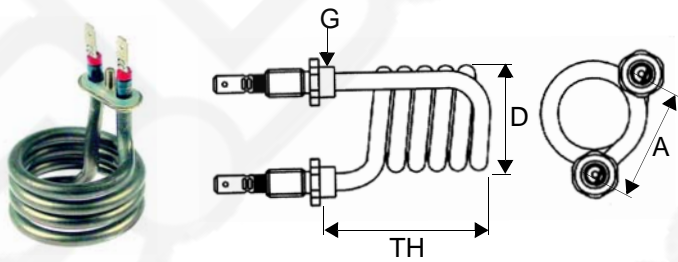

Pos. Item	B.-Nr. O.-No.	HK	U (V)	P (W)	G	(in mm)			Pass. für Suit. for
						TH	D	A	
1	417175	1	230	800	1/4"	40	50	33	Elektra
2	417162	1	230	800	M10x1	55	51	36	Astoria
3	417114	1	230	800	1/4"	70	60	33,5	Faema
4	417115	1	230	850	1/4"	45	67	20	Faema
5	417113	1	230	1000	1/4"	55	58	37	Faema
6	417035	1	230	1200	1/4"	70	55	37	Brasilia
7	417054	1	230	1400	1/4"	70	70	40	Nuova Simonelli
8	417189	1	230	1800	M10x1	70	57	35	Brasilia