

Magnetventile/Solenoid valves

Scem/Parker



Abb. Pict.	Bestell-Nr. Order-No.	Beschreibung Description
1	370057	kpl., 3 Wege, 230VAC cpl., 3 ways, 230VAC
2	370062	Ventilkörper Solenoid square pin
3	370206	kpl., 1/8", 2 Wege, 230V cpl., 1/8", 2 ways, 230V
4	371029	Magnetspule, 230V Magnetic coil, 230V

Lucifer



Abb. Pict.	Bestell-Nr. Order-No.	Beschreibung Description
1	370053	kpl., 3 Wege, 230VAC cpl., 3 ways, 230VAC
2	370061	Ventilkörper Solenoid square pin
3	370072	kpl., 1/8", 2 Wege, 230VAC cpl., 1/8", 2 ways, 230VAC
4	371031	Magnetspule, 230VAC Magnetic coil, 230VAC

ODE

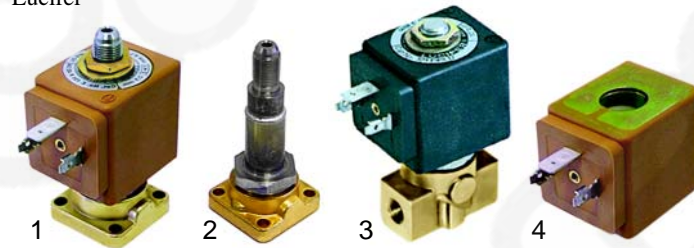

Abb. Pict.	Bestell-Nr. Order-No.	Beschreibung Description
1	370203	kpl., 3 Wege, 230VAC cpl., 3 ways, 230VAC
2	371150	Magnetspule, 230VAC Magnetic coil, 230VAC

Magnetventile Zubehör/Solenoid valve accessories

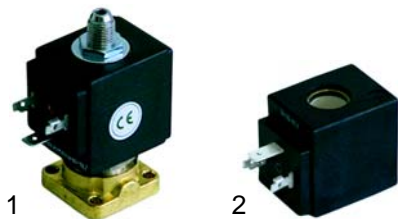

Abb. Pict.	Bestell-Nr. Order-No.	Beschreibung Description
1	371090	Stecker/groß Plug/big
2	371095	O-Ring/viton O-Ring/viton
3	371100	O-Ring/Silikon O-Ring/Silicon

Pressostate/Pressure switches

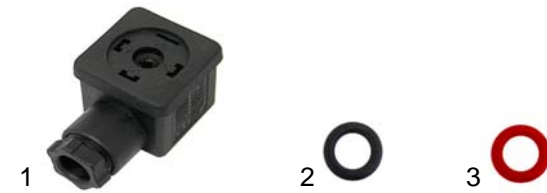

Abb. Pict.	B.-Nr. O.-No.	Beschreibung Description	Gerätetyp Device type	V.-Nr. C.-No.
1	541021	Pressostat, 3-polig Pressure switch, 3 poles		00049035
2	541143	Pressostat, 1-polig, 1/8" Pressure switch, 1 pole, 1/8"	S1, S1C, SX, SXC	01344035

Thermostate/Thermostats



Abb. Pict.	Best.-Nr. Ord.-No.	Beschreibung Description	Gerätet. Device t.	Ver.-Nr. Co.-No.
1	390128	Anlegethermostat, 95°C Stoke thermostat, 95°C	Capuccino	00701035
1	390129	Anlegethermostat, 125°C Stoke thermostat, 125°C	Capuccino	00700035
1	390327	Sicherheitsthermostat, 150°C Safety thermostat, 150°C	Capuccino	00702035
2	390153	Sicherheitsthermostat, 135°C Safety thermostat, 135°C	P, PC, PG, P1, PIC, PIG	00277035
3	390378	Sicherheitsthermostat Safety thermostat	S1, S1C, SX, SXC	01194035

Schalter, Lampen/Switches, lamps



Abb. Pict.	Best.-Nr. Ord.-No.	Beschreibung Description	Gerätetyp Device type	Vergl.-Nr. Comp.-No.
1	346004	Hauptschalter, 1 - 2 Gruppen Main switch, 1 - 2 groups	S1, S1C, SX, SXC, Deliziosa, Compact,	00056035
2	110205	Knebel Knob	Maxi, Extramaxi, P, P1, PC, PG, P1C, P1G	



Abb. Pict.	Best.-Nr. Ord.-No.	Beschreibung Description	Gerätetyp Device type	Vergl.-Nr. Comp.-No.
1	301001	Schalter/rot Switch/red	SX, SXC, S1, S1CO, S1CB,	00492035
2	301060	Schalter/rot Switch/red		01603035
3	301038	Schalter/grün Switch/green		00632034
3	301039	Schalter/rot Switch/red	SX, SXC, SXCD	01607034
4	301040	Schalter/grün Switch/green		00631034
4	301044	Taster/grün Push button/green		01606034



Abb. Pict.	Best.-Nr. Ord.-No.	Beschreibung Description	Gerätetyp Device type	Vergl.-Nr. Comp.-No.
1	346019	Schaltergruppe/kpl. Group switch/cpl.	Deliziosa, Compact,	00746034
2	345722	Schalter, 1-pol. Switch, 1-pol.	Maxi, Extramaxi,	01221035
3	345720	Schalter, 2-pol. Switch, 2-pol.	P, PC, PCG, P1, P1C, P1G	01222035

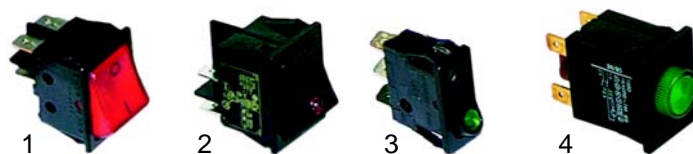

Abb. Pict.	Best.-Nr. Ord.-No.	Beschreibung Description	Gerätetyp Device type	Vergl.-Nr. Comp.-No.
1	359237	Signallampe/rot Signal lamp/red	S1, S1C, SX, SXC,	00073035
2	359238	Signallampe/grün Signal lamp/green	Deliziosa, Compact,	01312035
3	359240	Ring/vergoldet Ring/gold-plated	Maxi, Extramaxi,	01311026
4	359242	Ring/verchromt Ring/chromium-plated	P, PC, PCG, P1, P1C, P1G	01311035



Abb. Pict.	Best.-Nr. Ord.-No.	Beschreibung Description	Gerätetyp Device type	Vergl.-Nr. Comp.-No.
1	346020	Rahmen Frame	Deliziosa, Compact,	00740035
2	346031	Drehscheibe Turntable	Maxi, Extramaxi,	00380035
3	346032	Druckknopf/Kaffee Push button/Coffee	P, PC, PCG, P1, P1C, P1G	00743073



Abb. Pict.	Bestell-Nr. Order-No.	Beschreibung Description	Vergl.-Nr. Comp.-No.
1	400019	RL30/1E-2C/F230V RL30/1E-2C/F230V	00189035
2	400214	Niveausonde, 140mm Level probe, 140mm	00191035

Schalter, Lampen/Switches, lamps

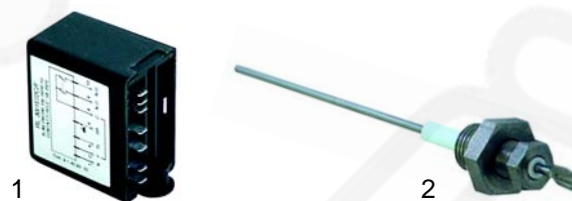

Pos. Item	B.-Nr. O.-No.	Beschreibung Description	Gerätetyp Device type	Vergl.-Nr. Comp.-No.
1	400361	Tastatur, DOSTH Key push button, DOSTH	Deliziosa, Compact, Maxi, Extramaxi, P, PC, PCG, PI, PIC, PIG	00384035

Heizkörper, 2-kreisig/Switches, 3 circuits



Abb. Pict.	Bestell-Nr. Order-No.	Beschreibung Description	Vergl.-Nr. Comp.-No.
1	417174	1 Gruppe, 2500W/240V 1 group, 2500W/240V	01195035
2	417155	2 Gruppen, 3000W/240V 2 groups, 3000W/240V	00127035
3	528171	Heizkörperdichtung Heater gasket	00499035



Pos. Item	B.-Nr. O.-No.	Beschreibung Description	Gerätetyp Device type	Vergl.-Nr. Comp.-No.
1	400297	Schlüsselschalter, 1 Gr. Key switch, 1 group	Deliziosa, Compact, Maxi,	00387035
2	400298	Schlüsselschalter, 2 Gr. Key switch, 2 groups	Extramaxi, P, PC, PCG, PI, PIC, PIG	00388035



Abb. Pict.	Bestell-Nr. Order-No.	Beschreibung Description	Gerätetyp Device type	Vergl.-Nr. Comp.-No.
1	417175	800W/230V 800W/230V		01192035
2	528182	Kesseldichtung Pot gasket	Microcasa	01168035

Flowmeter/Flowmeter



Abb. Pict.	Bestell-Nr. Order-No.	Beschreibung Description	Vergl.-Nr. Comp.-No.
1	400004	Flowmeter, 1/4" Flowmeter, 1/4"	
2	400256	Stecker Plugs	
3	400257	Zählrad Flow-meter reel	
4	400258	Gehäusedichtung Case gasket	

Manometer/Manometers



Abb. Pict.	Bestell-Nr. Order-No.	Beschreibung Description	Gerätetyp Device type	Vergl.-Nr. Comp.-No.
1	541253	Verchromt Chromium-plated	S1, S1C,	00143035
2	541254	Messing brass	SX, SXC	00398035



Abb. Pict.	Best.-Nr. Ord.-No.	Beschreibung Description	Gerätetyp Device type	Ver.-Nr. Co.-No.
1	541255	Doppelskala, vergoldet Double scale, gold-plated	Compact, Maxi,	00985026
2	541264	Doppelskala Double scale	Extramaxi, P, PC, PG, PI, PIC, PIG	02218035

Ventile/Valves



Abb. Pict.	Bestell-Nr. Order-No.	Beschreibung Description	Vergl.-Nr. Comp.-No.
1	529312	Sicherheitsventil, 1,8bar, 3/8" Safety valve, 1,8bar, 3/8"	01618034
2	529316	Sicherheitsventil/plombiert, 1,8bar, 3/8" Safety valve/sealt, 1,8bar, 3/8"	
3	529303	Entlüftungsventil, 1/4" Empty valve, 1/4"	00200034
5	529349	Cu-Dichtung, 3/8" Cu-gasket, 3/8"	01172035
6	529361	Cu-Dichtung, 1/4" Cu-gasket, 1/4"	

Wasserstandsglas/Level glass



Abb. Pict.	Bestell-Nr. Order-No.	Beschreibung Description	Vergl.-Nr. Comp.-No.
1	529448	Wasserstandsglas Level glass	00141035
2	529449	Wasserstandsglasdichtung Level glass gasket	00119035
3	529450	Druckscheibe Press washer	01380035
4	529451	Überwurfschraube/verchromt Pipe upper nut/chromium-plated	00041021
5	529452	Überwurfschraube/lackiert Pipe upper nut/varnished	00041019
6	529453	Schraube/verchromt Screw/chromium-plated	00142021
7	529454	Schraube/lackiert Screw/varnished	00142019
8	529455	Schutz/verchromt Contactor/chromium-plated	00043021
9	529456	Schutz/lackiert Contactor/varnished	00043019
10	529457	Seegerring/CNS Seeger circlip ring/stainless steel	00044035



Abb. Pict.	Bestell-Nr. Order-No.	Beschreibung Description	Vergl.-Nr. Comp.-No.
1	529340	Rückschlagventil Non-return valve	00330034
2	529341	Expansionsventil Expansion valve	00422034

Passend für/Suitable for Elektra

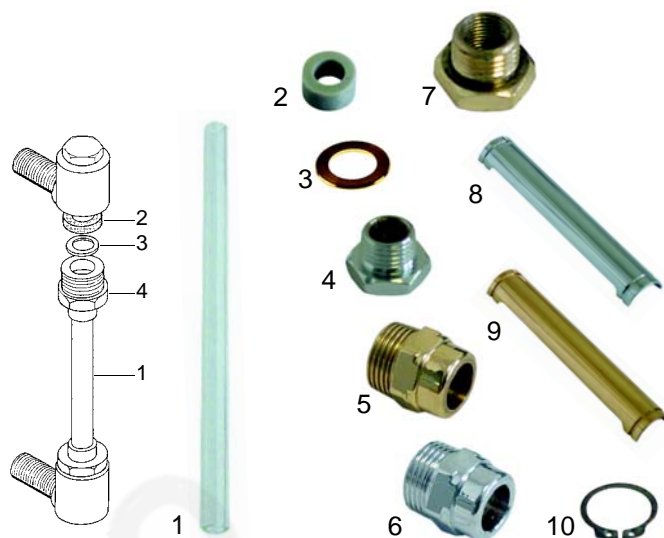
1 Wasserstandsglas/Level glass



Abb. Pict.	Bestell-Nr. Order-No.	Beschreibung Description	Gerätetyp Device type	Vergl.-Nr. Comp.-No.
1	529458	Wasserstandsglas/kpl. Level glass/cpl.	P, PC, PG, P1, P1C, P1G	01096039



Abb. Pict.	B.-Nr. O.-No.	Beschreibung Description	Gerätet. Device t.	Ver.-Nr. Co.-No.
1	529783	Überwurfschraube/verchromt Pipe upper nut/chromium-plated		01280021
2	529784	Überwurfschraube/Messing Pipe upper nut/brass		01280019
3	529785	Dampfrohr/verchromt Steam pipe/chromium-plated	S1, S1C, SX, SXC	00151039
4	529786	Dampfrohr/Kupfer Steam pipe/copper		00151038
5	529787	Düse/verchromt Nozzle/chromium-plated		00088021
6	529788	Düse/Messing Nozzle/brass		00088019



Abb. Pict.	Bestell-Nr. Order-No.	Beschreibung Description	Gerätetyp Device type	Vergl.-Nr. Comp.-No.
2	529459	Unterteil Bottom part		01025031
3	529460	Dichtung Gasket	P, PC, PG, P1, P1C, P1G	00543035
4	529461	Glas Glass		00544035
5	529462	Oberteil Upper part		00899021

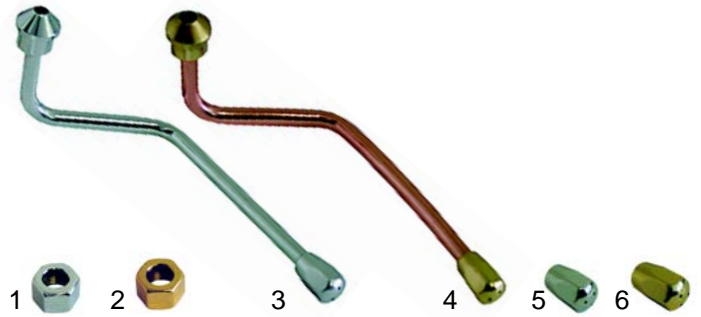

Abb. Pict.	B.-Nr. O.-No.	Beschreibung Description	Gerätetyp Device type	Ver.-Nr. Co.-No.
1	529811	Hahn/kpl. (Messing) Tab/cpl. (brass)		00690038
2	529812	Hahn/kpl. (verchromt) Tab/cpl. (chromium-plated)	P, PC, PG, P1, P1C, P1G	00690039
3	529813	Knebel Button		01898035
4	529814	Scheibe Washer		00953030

Hähne, Rohre/Tabs, pipes

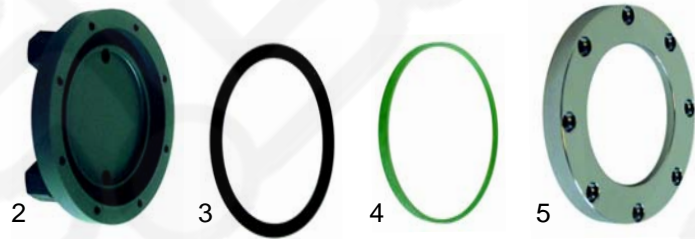

Abb. Pict.	Bestell-Nr. Order-No.	Beschreibung Description	Gerätetyp Device type	Vergl.-Nr. Comp.-No.
1	529780	Hahn/verchromt Tab/chromium-plated		00150021
2	529781	Hahn/Messing Tab/brass	S1, S1C, SX, SXC	00150019
3	529782	Knebel Button		00154035

Mini Deliziosa/compact/verticale



Abb. Pict.	Best.-Nr. Ord.-No.	Beschreibung Description	Gerätetyp Device type	Ver.-Nr. Co.-No.
1	529794	Dichtungsträger Gasketholder		00042014
2	529795	Dichtung Gasket	Compact, Maxi, Extramaxi,	01245035
3	529796	Dichtung/Teflon, konisch Gasket/teflon, conical		P, PC, PG, P1, P1C, P1G
4	529797	Federführung Spring guide		00045014
5	529798	Feder Spring		01189035

Rohre/Pipes



Abb. Pict.	Bestell-Nr. Order-No.	Beschreibung Description	Vergl.-Nr. Comp.-No.
1	529800	Dampfrohr/CNS Steam pipe/stainless steel	00469011
2	529801	Düse Nozzle	00448014
3	529802	Dichtung Gasket	01888035
4	529803	Feder Spring	01912035
5	529804	Buchse Bush	01913014
6	529805	Dichtung Gasket	01893035
7	529806	Überwurfschraube/verchromt Pipe upper nut/chromium-plated	00946021
8	529807	Überwurfschraube/Messing Pipe upper nut/brass	00946019

Gruppe/Group



Abb. Pict.	Best.-Nr. Ord.-No.	Beschreibung Description	Gerätetyp Device type	Ver.-Nr. Com.-No.
1	529170	Gruppendichtung, Alt Group gasket, old	S1, S1C, SX, SXC, Deliziosa, Compact,	00098035
2	529171	Gruppendichtung, Neu Group gasket, new	Maxi, Extramaxi, P, P1, PC, PG, PIC, PIG	01228035

Gruppe/Group



Abb. Pict.	B.-Nr. O.-No.	Beschreibung Description	Gerätet. Device t.	V.-Nr. C.-No.
1	525005	Hebelgruppe/kpl. (verchromt) Lever group/kpl. (chromium-plated)		00131039
2	525006	Hebelgruppe/kpl. (Messing) Lever group/kpl. (brass)	S1, S1C	00131038
3	111160	Hebel/verchromt Lever/chromium-plated		00176039
4	111161	Hebel/Messing Lever/brass		00176038

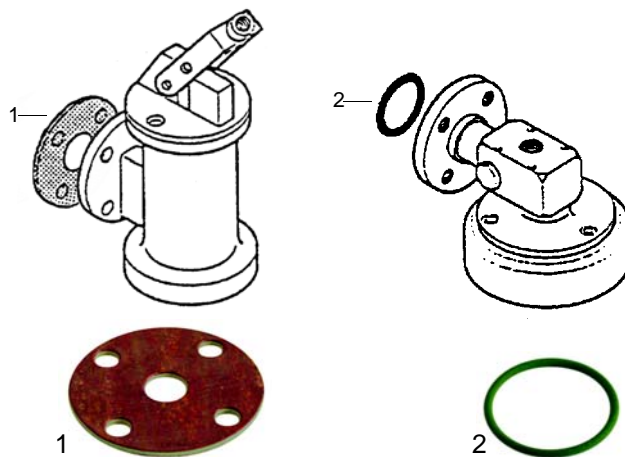

Abb. Pict.	Bestell-Nr. Order-No.	Beschreibung Description	Gerätetyp Device type	Vergl.-Nr. Comp.-No.
3	529173	Feder, Neu Spring, new		00819014
4	529174	Dichtung/V-Form Gasket/V-design		00172035
5	529175	Dichtung/W-Form Gasket/W-design	S1, S1C	00173035
6	529176	Siebträgerdichtung Filter holder gasket		00174035



Abb. Pict.	Bestell-Nr. Order-No.	Beschreibung Description	Gerätetyp Device type	Vergl.-Nr. Comp.-No.
1	529177	Dusche Shower		00175035
2	529178	Sieb/1 Tasse (6g) Filter/1 cup (6g)	S1, S1C, SX, SXC	00164035
3	529179	Sieb/2 Tassen (12g) Filter/2 cups (12g)		00163035

Rohre/Pipes Mini Deliziosa, Compact, Verticale



Abb. Pict.	B.-Nr. O.-No.	Beschreibung Description	Gerätetyp Device type	V.-Nr. C.-No.
1	529180	Siebträger/Messing Filter holder/brass		00187019
2	529181	Siebträger/verchromt Filter holder/chromium coated		00187021
3	529182	Stiftschraube Pin screw		00186035
4	529183	Griff/Kunststoff Knob/plastic	S1, S1C, SX, SXC	00469035
5	529184	Mutter/Messing Nut/brass		01367019
6	529185	Griff/Holz Knob/wood		00177014

Gruppe/Group

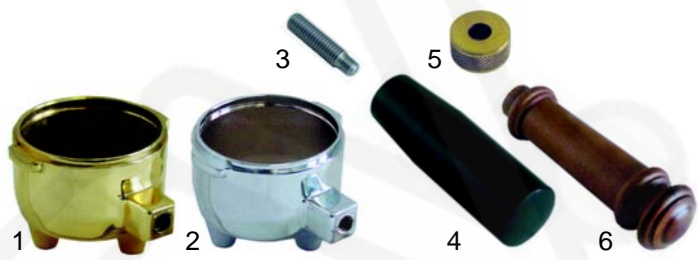

Abb. Pict.	Bestell-Nr. Order-No.	Beschreibung Description	Vergl.-Nr. Comp.-No.
1	529186	Glockendichtung/Viton Bell gasket/viton	01204035
2	529187	Dichtung Gasket	01386035
3	529188	Düse, 0,9mm Nozzle, 0,9mm	01336014
4	529190	Dichtung Gasket	01228035
5	529191	Feder Spring	01242035
6	529192	Sieb Filter	00111035

Dusche/Shower

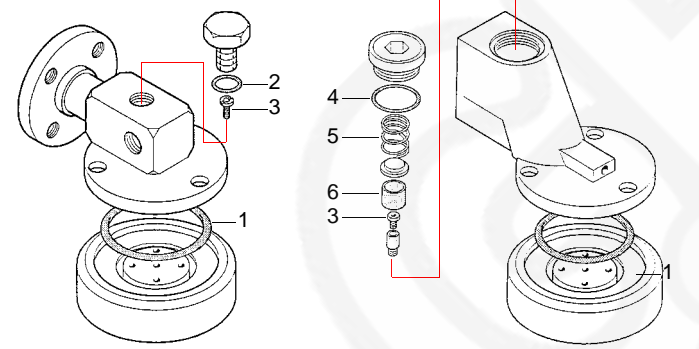

Abb. Pict.	Bestell-Nr. Order-No.	Beschreibung Description	Vergl.-Nr. Comp.-No.
1	529194	Verteiler Dispersion	01252014
2	529193	Dusche Shower	01208035
3	529195	Siebträgerdichtung Filter holder gasket	01917035

Sieb/Filter

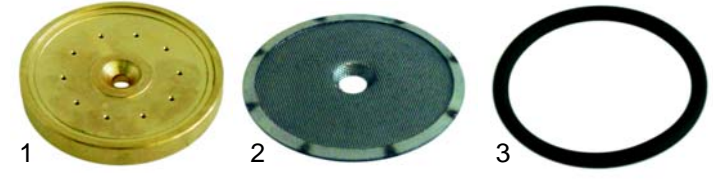

Abb. Pict.	Bestell-Nr. Order-No.	Beschreibung Description	Vergl.-Nr. Comp.-No.
1	529196	Sieb (1 Tasse/7g) Filter (1 cup/7g)	00065035
2	529197	Sieb (2 Tassen/14g) Filter (2 cups/14g)	00066035
3	529079	Siebträgerfeder Filter holder spring	013040335

Siebträger/Filter holder

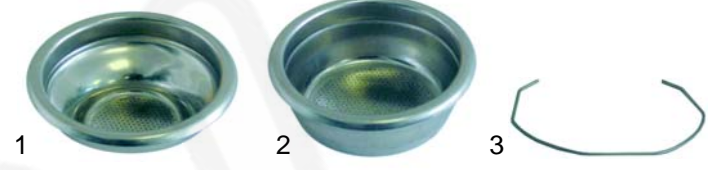

Abb. Pict.	Bestell-Nr. Order-No.	Beschreibung Description	Vergl.-Nr. Comp.-No.
1	529198	Siebträger/verchromt Filter holder/chromium-plated	00061021
2	529199	Siebträgergriff Filter holder handle	01897035

Ausläufe/Spouts

Mini Deliziosa, Compact, Verticale



Abb. Pict.	Bestell-Nr. Order-No.	Beschreibung Description	Vergl.-Nr. Comp.-No.
1	529003	Auslauf 3/8", 1 Weg gebogen Spout 3/8", one way curved	01308021
2	529007	Auslauf 3/8", 2 Wege kurz Spout 3/8", two way short	
3	529161	Auslauf 3/8", 2 Wege, regulierbar Spout 3/8", two way, regulable	00064021